

Table of Contents

Products	Group
▶ Tube Fittings	1
▶ Pipe Fittings	2
▶ Tubes & Pipes	3
▶ Brackets	4
▶ Pneumatic Cable & Tubes	5
▶ Plastic Tube Fittings	6
▶ Air Distributors	7
▶ Air Regulators & Filters	8
▶ Pneumatik Valves	9
▶ Cabinets, Boxes & Accessories	10
▶ Module Cabinets	11
▶ Ball & Neddle Valves	12
▶ Valve Manifolds	13
▶ Flow Regulators & Gauges	14
▶ Bolt & Nuts	15
▶ Packing & Seals	16
▶ Electric Cable & Cable Glands	17
▶ Tools & Accessories	18



I . A . C . Komponenter AB

International Automation Components

P.O Box 60, S-566 22 Habo Phone: +46 (0)36 477 00 Fax: +46 (0)36 477 15

E-mail: habo@iackomp.se www.iackomp.se



Certificate No 488/94

Tube Fittings

Compression Couplings

- Safelok • Stainless steel SS 316 - 2343 • NPT - American taper thread
- BSPP (R) - European parallel thread • BSPT (KR) - European taper thread
- Also available in fractional and 3, 4, 20, 22, 25 mm.



Tube x Thread	Type.No.	Part.No.		
Male Connector		NPT	BSPP	BSPT
3 mm x 1/8"	3m MC2	42-120	42-130	*
3 mm x 1/4"	3m MC4	42-121	42-131	*
6 mm x 1/8"	6m MC2	42-200	42-300	42-800
6 mm x 1/4"	6m MC4	42-201	42-301	42-801
6 mm x 3/8"	6m MC6	42-202	42-303	42-802
6 mm x 1/2"	6m MC8	42-203	42-302	42-803
8 mm x 1/8"	8m MC2	42-204	42-304	42-804
8 mm x 1/4"	8m MC4	42-205	42-307	42-805
8 mm x 3/8"	8m MC6	42-2051	42-3071	42-8051
8 mm x 1/2"	8m MC8	42-2052	*	*
10 mm x 1/4"	10m MC4	42-206	42-308	42-806
10 mm x 3/8"	10m MC6	42-207	42-309	42-807
10 mm x 1/2"	10m MC8	42-208	42-306	42-808
12 mm x 1/4"	12m MC4	42-210	42-310	42-810
12 mm x 3/8"	12m MC6	42-211	42-311	42-811
12 mm x 1/2"	12m MC8	42-212	42-312	42-812
12 mm x 3/4"	12m MC12	42-213	42-313	42-813
15 mm x 3/8"	15m MC6	42-2132	42-3131	42-814
15 mm x 1/2"	15m MC8	42-2133	42-3132	42-815
16 mm x 3/8"	16m MC6	*	42-3134	*
16 mm x 1/2"	16m MC8	42-2136	42-3135	*
18 mm x 1/2"	18m MC8	42-214	42-314	*
18 mm x 3/4"	18m MC12	42-2141	42-3141	42-8141
20 mm x 3/8"	20m MC6	42-2143	42-3143	*
20 mm x 1/2"	20m MC8	42-2144	42-3144	*
20 mm x 3/4"	20m MC12	42-2145	42-3145	*
22 mm x 1/2"	22m MC8	42-215	42-315	*
22 mm x 3/4"	22m MC12	42-2151	42-3151	*
25 mm x 3/8"	25m MC6	42-2155	42-3155	*
25 mm x 1/2"	25m MC8	42-2156	42-3156	*
25 mm x 3/4"	25m MC12	42-2157	42-3157	*
25 mm x 1"	25m MC16	42-2158	42-3158	*

Male Connector with o-ring		BSPP
6 mm x 1/8"	6m MC2-OR	42-900
6 mm x 1/4"	6m MC4-OR	42-901
6 mm x 3/8"	6m MC6-OR	42-902
12 mm x 1/4"	12m MC4-OR	42-910
12 mm x 3/8"	12m MC6-OR	42-911
12 mm x 1/2"	12m MC8-OR	42-912

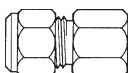

Female Connector	NPT	BSPP	BSPT	
6 mm x 1/8"	6m FC2	42-216	42-316	42-816
6 mm x 1/4"	6m FC4	42-217	42-317	42-817
6 mm x 3/8"	6m FC6	*	42-318	*
8 mm x 1/8"	8m FC2	42-2182	*	42-818
8 mm x 1/4"	8m FC4	42-219	42-319	42-819
10 mm x 1/4"	10m FC4	42-221	42-321	42-820
10 mm x 3/8"	10m FC6	42-222	42-326	42-821
10 mm x 1/2"	10m FC8	42-2221	*	42-822
12 mm x 1/4"	12m FC4	42-223	42-323	42-823
12 mm x 3/8"	12m FC6	42-224	42-324	42-824
12 mm x 1/2"	12m FC8	42-225	42-325	42-825

cont.

* - by order



I . A . C . Komponenter AB

International Automation Components

P.O Box 60, S-566 22 Habo Phone: +46 (0)36 477 00 Fax: +46 (0)36 477 15

E-mail: habo@iackomp.se www.iackomp.se



Certificate No 488/94

Tube Fittings

Compression Couplings

- Safelok • Stainless steel SS 316 - 2343 • NPT - American taper thread
- BSPP (R) - European parallel thread • BSPT (KR) - European taper thread
- Also available in fractional and 3, 4, 20, 22, 25 mm.

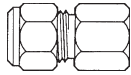

Tube x Thread	Type.No.	Part.No.		
---------------	----------	----------	--	--

Female Connector		NPT	BSPP	BSPT
15 mm x 1/2"	15m FC8	*	42-3272	*
16 mm x 1/4"	16m FC4	42-226	42-3273	*
16 mm x 1/2"	16m FC8	42-2262	42-3275	*
18 mm x 1/2"	18m FC8	42-227	*	*
18 mm x 3/4"	18m FC12	42-2271	*	*
20 mm x 1/2"	20m FC8	42-228	*	*

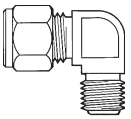

Female Stud Elbow		NPT	BSPP	BSPT
-------------------	--	-----	------	------

6 mm x 1/8"	6m ME2	42-230	42-330	42-830
6 mm x 1/4"	6m ME4	42-231	42-331	42-831
6 mm x 3/8"	6m ME6	42-232	*	*
8 mm x 1/8"	8m ME2	42-2322	*	42-832
8 mm x 1/4"	8m ME4	42-233	42-333	42-833
8 mm x 3/8"	8m ME6	42-2331	*	*
8 mm x 1/2"	8m ME8	42-2332	*	*
10 mm x 1/4"	10m ME4	42-234	42-339	42-834
10 mm x 3/8"	10m ME6	42-235	42-340	42-835
10 mm x 1/2"	10m ME8	42-2351	*	42-836
12 mm x 1/4"	12m ME4	42-238	42-341	42-837
12 mm x 3/8"	12m ME6	42-236	42-336	42-838
12 mm x 1/2"	12m ME8	42-237	42-337	42-839
15 mm x 3/8"	15m ME6	42-2372	*	*
15 mm x 1/2"	15m ME8	42-2373	*	*
16 mm x 3/8"	16m ME6	*	42-3414	*
16 mm x 1/2"	16m ME8	42-240	42-3415	42-8395
18 mm x 1/2"	18m ME8	42-2375	42-342	42-840
18 mm x 3/4"	18m ME12	42-2376	*	*
20 mm x 3/8"	20m ME6	42-2423	42-3423	*
20 mm x 1/2"	20m ME8	42-2424	42-3424	*
20 mm x 3/4"	20m ME12	42-2425	42-3425	*
22 mm x 1/2"	22m ME8	42-243	42-343	*
22 mm x 3/4"	22m ME12	42-2431	42-3431	*
25 mm x 3/8"	25m ME6	42-2435	42-3435	*
25 mm x 1/2"	25m ME8	42-2436	42-3436	*
25 mm x 3/4"	25m ME12	42-2437	42-3437	*

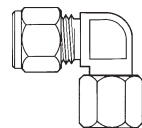

Female Stud Elbow		NPT	BSPP	BSPT
-------------------	--	-----	------	------

6 mm x 1/8"	6m FE2	42-105	*	*
6 mm x 1/4"	6m FE4	42-106	*	*
8 mm x 1/8"	8m FE2	42-107	*	*
8 mm x 1/4"	8m FE4	42-108	*	*
10 mm x 1/8"	10m FE2	42-109	*	*
10 mm x 1/4"	10m FE4	42-110	*	*
10 mm x 3/8"	10m FE6	42-1101	*	*
12 mm x 1/4"	12m FE4	42-111	*	*
12 mm x 3/8"	12m FE6	42-112	*	*
12 mm x 1/2"	12m FE8	42-113	42-137	*

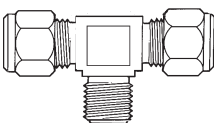

Male Branch Tee		NPT	BSPP	BSPT
-----------------	--	-----	------	------

6 mm x 1/8"	6m TTM2	42-270	42-370	*
6 mm x 1/4"	6m TTM4	42-271	42-371	*
8 mm x 1/4"	8m TTM4	42-272	42-372	*
10 mm x 1/4"	10m TTM4	42-273	42-373	*
12 mm x 3/8"	12m TTM6	42-276	42-376	*
12 mm x 1/2"	12m TTM8	42-277	42-377	*
16 mm x 1/2"	16m TTM8	42-2776	*	*
18 mm x 3/4"	18m TTM12	42-2781	*	*



I . A . C . Komponenter AB

International Automation Components

P.O Box 60, S-566 22 Habo Phone: +46 (0)36 477 00 Fax: +46 (0)36 477 15

E-mail: habo@iackomp.se www.iackomp.se



Certificate No 488/94

Tube Fittings

Compression Couplings

- Safelok • Stainless steel SS 316 - 2343 • NPT - American taper thread
- BSPP (R) - European parallel thread • BSPT (KR) - European taper thread
- Also available in fractional and 3, 4, 20, 22, 25 mm.

Tube x Thread	Type.No.	Part.No.		
Male Run Tee				
		NPT	BSPP	BSPT
6 mm x 1/8"	6m TMT2	42-280	42-290	*
6 mm x 1/4"	6m TMT4	42-281	42-291	*
8 mm x 1/4"	8m TMT4	42-283	42-293	*
10 mm x 1/4"	10m TMT4	42-284	42-294	*
12 mm x 3/8"	12m TMT6	42-286	42-296	42-886
12 mm x 1/2"	12m TMT8	42-287	42-297	42-887
16 mm x 1/2"	16m TMT8	42-2876	*	*
18 mm x 3/4"	18m TMT12	42-2881	*	*
Male Bulkhead Connector				
		NPT	BSPP	BSPT
12 mm x 1/4"	12m MBH4	42-4905	*	*
12 mm x 3/8"	12m MBH6	42-491	*	42-853
12 mm x 1/2"	12m MBH8	42-490	*	*
Female Bulkhead Connector				
		NPT	BSPP	BSPT
10 mm x 1/4"	10m FBH4	42-494	*	*
12 mm x 1/2"	12m FBH8	42-495	*	*
Straight Union				
6 mm	6m U		42-244	
8 mm	8m U		42-245	
10 mm	10m U		42-247	
12 mm	12m U		42-246	
15 mm	15m U		42-2473	
16 mm	16m U		42-2471	
18 mm	18m U		42-2472	
20 mm	20m U		42-2474	
22 mm	22m U		42-2475	
25 mm	25m U		42-248	
Equal Elbow				
6 mm	6m ELU		42-250	
8 mm	8m ELU		42-251	
10 mm	10m ELU		42-252	
12 mm	12m ELU		42-253	
15 mm	15m ELU		42-2533	
16 mm	16m ELU		42-2534	
18 mm	18m ELU		42-2532	
20 mm	20m ELU		42-2536	
22 mm	22m ELU		42-2535	
25 mm	25m ELU		42-254	
Union Tee				
6 mm	6m TTT		42-264	
8 mm	8m TTT		42-265	
10 mm	10m TTT		42-266	
12 mm	12m TTT		42-267	
15 mm	15m TTT		42-2673	
16 mm	16m TTT		42-268	
18 mm	18m TTT		42-269	
20 mm	20m TTT		42-2693	
22 mm	22m TTT		42-2695	
25 mm	25m TTT		42-2698	

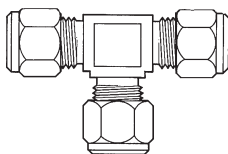
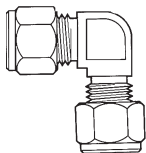
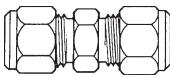
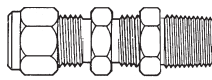
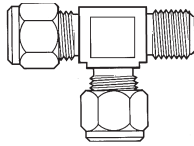

I . A . C . Komponenter AB

International Automation Components

P.O Box 60, S-566 22 Habo Phone: +46 (0)36 477 00 Fax: +46 (0)36 477 15

E-mail: habo@iackomp.se www.iackomp.se



Certificate No 488/94

Tube Fittings

Compression Couplings

- Safelok • Stainless steel SS 316 - 2343 • NPT - American taper thread
- BSPP (R) - European parallel thread • BSPT (KR) - European taper thread
- Also available in fractional and 3, 4, 20, 22, 25 mm.

Tube x Thread	Type.No.	Part.No.
---------------	----------	----------

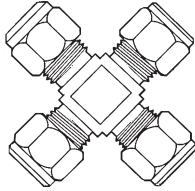

Union Cross

6 mm	6m UC	42-344
8 mm	8m UC	42-345
10 mm	10m UC	42-346
12 mm	12m UC	42-347

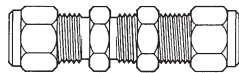

Bulkhead Union

6 mm	6m BHU	42-256
8 mm	8m BHU	42-257
10 mm	10m BHU	42-258
12 mm	12m BHU	42-259
15 mm	15m BHU	42-260
16 mm	16m BHU	42-2605
18 mm	18m BHU	42-261

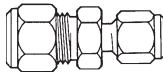

Reducing Union

8 mm x 6 mm	8m RU6	42-350
10 mm x 6 mm	10m RU6	42-351
10 mm x 8 mm	10m RU8	42-3512
12 mm x 6 mm	12m RU6	42-352
12 mm x 8 mm	12m RU8	42-3522
12 mm x 10 mm	12m RU10	42-353
16 mm x 12 mm	16m RU12	42-354
18 mm x 12 mm	18m RU12	42-355

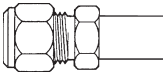

Reducing Adaptor

6 mm x tube 8 OD	6m RED8	42-360
6 mm x tube 10 OD	6m RED10	42-361
6 mm x tube 12 OD	6m RED12	42-362
8 mm x tube 10 OD	8m RED10	42-364
8 mm x tube 12 OD	8m RED12	42-365
10 mm x tube 12 OD	10m RED12	42-363
12 mm x tube 16 OD	12m RED16	42-366
12 mm x tube 18 OD	12m RED18	42-367
18 mm x tube 12 OD	18m RED12	42-368

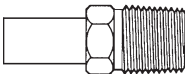

Male Stud Standpipe Adaptor

Tube	Male Stud Standpipe Adaptor	NPT	BSPP	BSPT
6 OD x 1/8"	6m ATPM2	*	42-431	*
6 OD x 1/4"	6m ATPM4	*	42-432	42-412
6 OD x 3/8"	6m ATPM6	*	42-433	*
6 OD x 1/2"	6m ATPM8	42-404	42-434	*
8 OD x 1/4"	8m ATPM4	*	42-437	*
10 OD x 1/4"	10m ATPM4	*	42-442	*
10 OD x 3/8"	10m ATPM6	*	42-443	*
10 OD x 1/2"	10m ATPM8	*	42-444	*
12 OD x 1/4"	12m ATPM4	42-427	42-447	*
12 OD x 3/8"	12m ATPM6	42-428	42-448	42-430
12 OD x 1/2"	12m ATPM8	42-429	42-449	*
16 OD x 1/2"	16m ATPM8	42-4295	*	*

Male Stud Standpipe Adaptor with o-ring

Tube	Male Stud Standpipe Adaptor with o-ring	BSPP
6 OD x 1/8"	6m ATPM2-OR	42-980
6 OD x 1/4"	6m ATPM4-OR	42-981
12 OD x 1/4"	12m ATPM4-OR	42-990
12 OD x 3/8"	12m ATPM6-OR	42-991
12 OD x 1/2"	12m ATPM8-OR	42-992

* - by order



I . A . C . Komponenter AB

International Automation Components

P.O Box 60, S-566 22 Habo Phone: +46 (0)36 477 00 Fax: +46 (0)36 477 15

E-mail: habo@iackomp.se www.iackomp.se



Certificate No 488/94

Tube Fittings

Compression Couplings

- Safelok • Stainless steel SS 316 - 2343 • NPT - American taper thread
- BSPP (R) - European parallel thread • BSPT (KR) - European taper thread
- Also available in fractional and 3, 4, 20, 22, 25 mm.

Tube	Type.No.	Part.No.	
Female Stud Standpipe Adaptor		NPT	BSPP (for gauge)
Tube 6 OD x 1/8"	6m ATPF2	*	42-461
Tube 6 OD x 1/4"	6m ATPF4	*	42-462
Tube 6 OD x 1/2"	6m ATPF8	42-451	42-464
Tube 8 OD x 1/4"	8m ATPF4	*	42-467
Tube 10 OD x 1/4"	10m ATPF4	*	42-472
Tube 10 OD x 3/8"	10m ATPF6	*	42-473
Tube 10 OD x 1/2"	10m ATPF8	*	42-474
Tube 12 OD x 1/4"	12m ATPF4	42-452	42-477
Tube 12 OD x 3/8"	12m ATPF6	*	42-478
Tube 12 OD x 1/2"	12m ATPF8	*	42-479
Tube 16 OD x 1/2"	16m ATPF8	42-450	*
Blanking End			
6 mm	6m BE		42-380
8 mm	8m BE		42-381
10 mm	10m BE		42-382
12 mm	12m BE		42-383
18 mm	18m BE		42-3835
Blanking Plug			
6 mm	BP 6m		42-385
8 mm	BP 8m		42-386
10 mm	BP 10m		42-387
12 mm	BP 12m		42-388
15 mm	BP 15m		42-3885
16 mm	BP 16m		42-3886
18 mm	BP 18m		42-389
Compression Nut			
3 mm	3m N		*
6 mm	6m N		42-390
8 mm	8m N		42-391
10 mm	10m N		42-392
12 mm	12m N		42-393
15 mm	15m N		42-3932
16 mm	16m N		42-3933
18 mm	18m N		42-3935
20 mm	20m N		42-3937
22 mm	22m N		42-3938
25 mm	25m N		42-3939
Front and Back Sealing			
3 mm	3m RC+FC		*
6 mm	6m RC+FC		42-395
8 mm	8m RC+FC		42-396
10 mm	10m RC+FC		42-397
12 mm	12m RC+FC		42-398
15 mm	15m RC+FC		42-399
16 mm	16m RC+FC		42-3993
18 mm	18m RC+FC		42-3995
20 mm	20m RC+FC		42-3997
22 mm	22m RC+FC		42-3998
25 mm	25m RC+FC		42-3999
Sealing Teflon			
12 mm			42-3985

* - by order



I . A . C . Komponenter AB

International Automation Components

P.O Box 60, S-566 22 Habo Phone: +46 (0)36 477 00 Fax: +46 (0)36 477 15
E-mail: habo@iackomp.se www.iackomp.se



Certificate No 488/94

Tube Fittings

Welding Fittings

- Safelok • Stainless steel SS 316 - 2343
- Other dimensions - on request



Tube x Thread	Type.No.	Part.No.
---------------	----------	----------

Tube Socket Weld Male Connector

10 mm x 1/4" NPT	10mmOD SW.MC4NPT	*
10 mm x 1/2" NPT	10mmOD SW.MC8NPT	*
12 mm x 1/4" NPT	12mmOD SW.MC4NPT	42-710
12 mm x 1/2" NPT	12mmOD SW.MC8NPT	42-712
14 mm x 1/4" NPT	14mmOD SW.MC4NPT	*
14 mm x 1/2" NPT	14mmOD SW.MC8NPT	*



Male Pipe Weld Connection

10 mm x 21,3 mm	BWC10mC2x1/2"NBW	*
12 mm x 21,3 mm	BWC12mC2x1/2"NBW	42-713
14 mm x 21,3 mm	BWC14mC2x1/2"NBW	*



Tube Socket Weld Union

10 mm	10mSW U	*
12 mm	12mSW U	42-746
14 mm	14mSW U	*



Tube Socket Weld Union Tee

10 mm	10mSW TTT	*
12 mm	12mSW TTT	42-767
14 mm	14mSW TTT	*



Male Adaptor Pipe But Weld Connection

21,3 mm x 3/4" NPT	1/2"NBW.MC12NPT	42-715
--------------------	-----------------	--------



Male Elbow Pipe Weld Connection

10 mm x 21,3 mm	BWE 12mC2x1/2"NBW	*
12 mm x 21,3 mm	BWE 12mC2x1/2"NBW	42-737
14 mm x 21,3 mm	BWE 12mC2x1/2"NBW	*



Tube Socket Weld Equal Elbow

10 mm	10mSW ELU	*
12 mm	12mSW ELU	42-753
14 mm	14mSW ELU	*

* by order



I . A . C . Komponenter AB

International Automation Components

P.O Box 60, S-566 22 Habo Phone: +46 (0)36 477 00 Fax: +46 (0)36 477 15

E-mail: habo@iackomp.se www.iackomp.se



Certificate No 488/94

Tube Fittings

Threads Compression Fittings

• Safelok • Stainless steel SS 316 - 2343

Standard Thread Sizes

BSPP - B.S.2779-1973 - European parallel pipe thread (R)

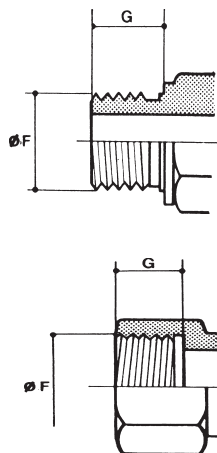

Male thread

Female thread

Inch	mm	Diam. F	Threads/Inch	G	Inch	mm	Diam. F	Threads/Inch	G
1/8	5,10	9,7	28	8	1/8	5,10	9,7	28	8,0
1/4	8,13	13,1	19	10	1/4	8,13	13,1	19	11,0
3/8	12,17	16,6	19	10	3/8	12,17	16,6	19	11,4
1/2	15,21	20,9	14	12	1/2	15,21	20,9	14	15,0
3/4	21,17	26,4	14	16	3/4	21,27	26,4	14	16,3
1	26,34	33,2	11	16	1	26,34	33,2	11	19,1

BSPT- B.S.21-1985 - European taper pipe thread (KR)

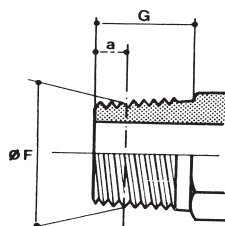

Male thread

Inch	mm	Diam. F	Threads/Inch	A	G
1/8	5,10	9,7	28	4,0	9,5
1/4	8,13	13,1	19	6,0	14,3
3/8	12,17	16,6	19	6,4	14,3
1/2	15,21	20,9	14	8,2	19,1
3/4	21,27	26,4	14	9,5	19,1
1	26,34	33,2	11	10,4	23,8

NPT- ANSI B2.1 - American taper pipe thread

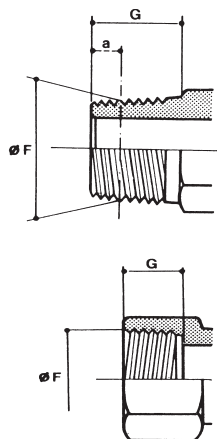

Male thread

Female thread

Inch	Diam. F	Threads/Inch	A	G	Inch	Diam. F	Threads/Inch	G
1/8	10,2	27	4,5	9,5	1/8	10,2	27	9,5
1/4	13,5	18	5,0	14,3	1/4	13,5	18	14,3
3/8	17,0	18	6,0	14,3	3/8	17,0	18	14,3
1/2	21,2	14	8,1	19,1	1/2	21,2	14	19,1
3/4	26,5	14	8,6	19,1				
1	33,2	11	10,6	23,8				



I . A . C . Komponenter AB

International Automation Components







P.O Box 60, S-566 22 Habo Phone: +46 (0)36 477 00 Fax: +46 (0)36 477 15

E-mail: habo@iackomp.se www.iackomp.se

Tube Fittings

Push-In Fittings

- Manufacture - ©: C.Matic • Stainless steel SS 316 - 2343
- Push-in fitting with grab ring for plastic or metal tube
- BSPT (KR) - European taper pipe thread • BSPP (R) - European parallel pipe thread
- Also available in other sizes, models and with other threads

Tube x Thread	Type.No.	Part.No.
Male Connector		BSPT (KR)
	6 mm x 1/8"	MX110618 47-003
	6 mm x 1/4"	MX110614 47-004
	8 mm x 1/8"	MX110818 47-005
	8 mm x 1/4"	MX110814 47-006
	10 mm x 1/4"	MX111014 47-008
	10 mm x 3/8"	MX111038 47-009
Male Connector		BSPP (R)
	6 mm x 1/8"	MX120618 47-013
	6 mm x 1/4"	MX120614 47-014
	8 mm x 1/8"	MX120818 47-015
	8 mm x 1/4"	MX120814 47-016
Male Swivel Elbow		BSPT (KR)
	6 mm x 1/8"	MX150618 47-023
	6 mm x 1/4"	MX150614 47-024
	8 mm x 1/8"	MX150818 47-025
	8 mm x 1/4"	MX150814 47-026
	10 mm x 1/4"	MX151014 47-028
	10 mm x 3/8"	MX151038 47-029
Male Swivel Elbow		BSPP (KR)
	6 mm x 1/8"	MX160618 47-033
	6 mm x 1/4"	MX160614 47-034
	8 mm x 1/8"	MX160818 47-035
	8 mm x 1/4"	MX160814 47-036
Male Swivel Branch Tee		BSPT (KR)
	6 mm x 1/8"	MX200618 47-043
	6 mm x 1/4"	MX200614 47-044
	8 mm x 1/8"	MX200818 47-045
	8 mm x 1/4"	MX200814 47-046
	10 mm x 1/4"	MX201014 47-048
	10 mm x 3/8"	MX201038 47-049
Male Swivel Branch Tee		BSPP (R)
	6 mm x 1/8"	MX210618 47-053
	6 mm x 1/4"	MX210614 47-054
	8 mm x 1/8"	MX210818 47-055
	8 mm x 1/4"	MX210814 47-056
Bulkhead Union		
	6 mm	MX270606 47-071
	8 mm	MX270808 47-072
	10 mm	MX271010 47-073



I . A . C . Komponenter AB

International Automation Components

P.O Box 60, S-566 22 Habo Phone: +46 (0)36 477 00 Fax: +46 (0)36 477 15

E-mail: habo@iackomp.se www.iackomp.se

Tube Fittings

Push-In Fittings

- Manufacture - ©: C.Matic • Stainless steel SS 316 - 2343
- Push-in fitting with grab ring for plastic or metal tube
- BSPT (KR) - European taper pipe thread • BSPP (R) - European parallel pipe thread
- Also available in other sizes, models and with other threads



Tube x Thread	Type.No.	Part.No.
Reducing Adaptor		
6 mm x OD8	MX250608	47-077
8 mm x OD10	MX250810	47-078
Straight Union		
6 mm	MX260606	47-081
8 mm	MX260808	47-082
10 mm	MX261010	47-083
Equal Elbow		
6 mm	MX280600	47-086
8 mm	MX280800	47-087
10 mm	MX281000	47-088
Union Tee		
6 mm	MX290600	47-091
8 mm	MX290800	47-092
10 mm	MX291000	47-093



I . A . C . Komponenter AB

International Automation Components

P.O Box 60, S-566 22 Habo Phone: +46 (0)36 477 00 Fax: +46 (0)36 477 15

E-mail: habo@iackomp.se www.iackomp.se

Tube Fittings

Biconical Fittings for Copper Tube

- MSB • Nickelplated brass
- Other dimension - on request



Tube x Thread	Part.No.
Male Connector	BSPT (KR)

6/4 mm x 1/8"	44-101
6/4 mm x 1/4"	44-102
8/6 mm x 1/4"	44-105
10/8 mm x 1/4"	44-108
12/10 mm x 3/8"	44-112
12/10 mm x 1/2"	44-113
1/4" x 1/8"	44-001
1/4" x 1/4"	44-002



Female Connector	BSPF (R)
-------------------------	-----------------

6/4 mm x 1/8"	44-116
6/4 mm x 1/4"	44-117
8/6 mm x 1/4"	44-120
10/8 mm x 1/4"	44-123
1/4" x 1/8"	44-016
1/4" x 1/4"	44-017



Male Stud Elbow	BSPT (KR)
------------------------	------------------

6/4 mm x 1/8"	44-131
6/4 mm x 1/4"	44-132
8/6 mm x 1/4"	44-135
10/8 mm x 1/4"	44-138
12/10 mm x 3/8"	44-142
12/10 mm x 1/2"	44-143
1/4" x 1/8"	44-031
1/4" x 1/4"	44-032



Male Branch Tee	BSPT (KR)
------------------------	------------------

6/4 mm x 1/8"	44-146
6/4 mm x 1/4"	44-147



Male Run Tee	BSPT (KR)
---------------------	------------------

6/4 mm x 1/8"	44-161
6/4 mm x 1/4"	44-162



Straight Union	
-----------------------	--

6/4 mm	44-176
8/6 mm	44-177
10/8 mm	44-178
12/10 mm	44-179
1/4"	44-076



Equal Elbow	
--------------------	--

6/4 mm	44-181
8/6 mm	44-182
10/8 mm	44-183
12/10 mm	44-184
1/4"	44-081



I . A . C . Komponenter AB

International Automation Components

P.O Box 60, S-566 22 Habo Phone: +46 (0)36 477 00 Fax: +46 (0)36 477 15

E-mail: habo@iackomp.se www.iackomp.se

Tube Fittings

Biconical Fittings for Copper Tube

- MSB • Nickelplated brass
- Other dimension - on request



Tube x Thread	Part.No.
---------------	----------

Union Tee	
-----------	--

6/4 mm	44-186
8/6 mm	44-187
10/8 mm	44-188
12/10 mm	44-189
1/4"	44-086



Bulkhead Union	
----------------	--

6/4 mm	44-126
1/4"	44-026



Nut	
-----	--

6/4 mm	44-191
8/6 mm	44-192
10/8 mm	44-193
12/10 mm	44-194
1/4"	44-091



Ferrule	
---------	--

6/4 mm	44-196
8/6 mm	44-197
10/8 mm	44-198
12/10 mm	44-199
1/4"	44-096



I . A . C . Komponenter AB

International Automation Components







P.O Box 60, S-566 22 Habo Phone: +46 (0)36 477 00 Fax: +46 (0)36 477 15

E-mail: habo@iackomp.se www.iackomp.se

Tube Fittings

Biconical Fittings

- Manufacture: Ermeto or similar • Stainless steel 2343-316
- BSPP (R) - European parallel thread • BSPT (KR) - European taper thread
- Other dimension - on request

Tube x Thread	Type.No.	Part.No.
Male Connector		R
	6 mm x 1/8"	GE 6-LR 1/8 SY 42-001
	6 mm x 1/4"	GE 6-LR 1/4 SY 42-002
	8 mm x 1/4"	GE 8-LR 1/4 SY 42-0022
	10 mm x 1/4"	GE 10-LR 1/4 SY 42-0024
	12 mm x 1/4"	GE 12-LR 1/4 SY 42-003
	12 mm x 3/8"	GE 12-LR 3/8 SY 42-004
	12 mm x 1/2"	GE 12-LR 1/2 SY 42-005
	12 mm x 3/4"	GE 12-LR 3/4 SY 42-006
	18 mm x 1/2"	GE 18-LR 1/2 SY 42-007
	20 mm x 3/4"	GE 20-SR 3/4 SY 42-0072
	30 mm x 1 1/2"	GE 30-SR 1 1/2 SY 42-0078
Female Connector		R
	6 mm x 1/8"	GAI 6-LR 1/8 SY 42-008
	12 mm x 3/8"	GAI 12-LR 3/8 SY 42-009
	12 mm x 1/2"	GAI 12-LR 1/2 SY 42-010
	16 mm x 1/2"	GAI 16-SR 1/2 SY 42-0104
	18 mm x 1/2"	GAI 18-LR 1/2 SY 42-011
Male Stud Elbow		KR
	6 mm x 1/8"	WE 6-LR 1/8 SY 42-014
	6 mm x 1/4"	WE 6-LR 1/4 SY 42-015
	8 mm x 1/4"	WE 8-LR 1/4 SY 42-0152
	10 mm x 1/4"	WE 10-LR 1/4 SY 42-0154
	12 mm x 1/4"	WE 12-LR 1/4 SY 42-016
	12 mm x 3/8"	WE 12-LR 3/8 SY 42-017
	12 mm x 1/2"	WE 12-LR 1/2 SY 42-018
	16 mm x 1/2"	WE 16-SR 1/2 SY 42-0182
	18 mm x 1/2"	WE 18-LR 1/2 SY 42-019
Straight Union		
	6 mm	G 6-L SY 42-020
	8 mm	G 8-L SY 42-0202
	10 mm	G 10-L SY 42-0204
	12 mm	G 12-L SY 42-021
	15 mm	G 15-L SY 42-0212
	18 mm	G 18-L SY 42-022
	30 mm	G 30-L SY 42-0228
Equal Elbow		
	6 mm	W 6-L SY 42-023
	8 mm	W 8-L SY 42-0232
	12 mm	W 12-L SY 42-024
	16 mm	W 16-L SY 42-0243
	18 mm	W 18-L SY 42-025
	30 mm	W 30-L SY 42-0258
Bulkhead Union		
	15 mm	SV 15-L SY 42-0275



I . A . C . Komponenter AB

International Automation Components

P.O Box 60, S-566 22 Habo Phone: +46 (0)36 477 00 Fax: +46 (0)36 477 15

E-mail: habo@iackomp.se www.iackomp.se

Tube Fittings

Biconical Fittings

- Manufacture: Ermeto or similar • Stainless steel 2343-316
- BSPP (R) - European parallel thread • BSPT (KR) - European taper thread
- Other dimension - on request



Tube x Thread	Type.No.	Part.No.
Union Tee		
6 mm	T 6-L SY	42-028
8 mm	T 8-L SY	42-0281
10 mm	T 10-L SY	42-0282
12 mm	T 12-L SY	42-029
15 mm	T 15-L SY	42-0292
16 mm	T 16-L SY	42-0293
18 mm	T 18-L SY	42-030
20 mm	T 20-L SY	42-0301
Male Branch Tee		KR
6 mm x 1/8"	TE 6-LR 1/8 SY	42-031
12 mm x 3/8"	TE 12-LR 3/8 SY	42-032
16 mm x 1/2"	TE 16-SR 1/2 SY	42-0324
Male Run Tee		KR
15 mm x 1/2"	LE 15-LR 1/2 SY	42-0392
16 mm x 1/2"	LE 16-SR 1/2 SY	42-040
Nut		
6 mm	M 6-L SY	42-033
12 mm	M 12-L SY	42-034
18 mm	M 18-L SY	42-035
Ferrule		
6 mm	D 6-L SY	42-036
12 mm	D12-L SY	42-037



I . A . C . Komponenter AB

International Automation Components

P.O Box 60, S-566 22 Habo Phone: +46 (0)36 477 00 Fax: +46 (0)36 477 15

E-mail: habo@iackomp.se www.iackomp.se



Certificate No 488/94

Tube Fittings

Compression Couplings Fractional

- Safelok • Stainless steel SS 316 - 2343 • NPT - American taper thread
- BSPP or BSPT on request



Tube x Thread	Type.No.	Part.No.
Male Connector		NPT
1/8" x 1/8"	2MC2	42-500
1/8" x 1/4"	2MC4	42-501
1/4" x 1/8"	4MC2	42-505
1/4" x 1/4"	4MC4	42-506
1/4" x 3/8"	4MC6	42-507
1/4" x 1/2"	4MC8	42-508
3/8" x 1/8"	6MC2	42-511
3/8" x 1/4"	6MC4	42-512
3/8" x 3/8"	6MC6	42-513
3/8" x 1/2"	6MC8	42-514
3/8" x 3/4"	6MC12	42-515
1/2" x 1/4"	8MC4	42-516
1/2" x 3/8"	8MC6	42-517
1/2" x 1/2"	8MC8	42-518
1/2" x 3/4"	8MC12	42-519
3/4" x 1/4"	12MC4	42-5197
3/4" x 1/2"	12MC8	42-520
3/4" x 3/4"	12MC12	42-521
1" x 3/4"	16MC12	42-522
1" x 1"	16MC16	42-523

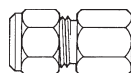

Female Connector		NPT
1/8" x 1/8"	2FC2	42-564
1/8" x 1/4"	2FC4	42-565
1/4" x 1/8"	4FC2	42-567
1/4" x 1/4"	4FC4	42-568
1/4" x 3/8"	4FC6	42-569
1/4" x 1/2"	4FC8	42-570
3/8" x 1/8"	6FC2	42-573
3/8" x 1/4"	6FC4	42-574
3/8" x 3/8"	6FC6	42-575
3/8" x 1/2"	6FC8	42-576
1/2" x 1/4"	8FC4	42-577
1/2" x 3/8"	8FC6	42-578
1/2" x 1/2"	8FC8	42-579
1/2" x 5/8"	8FC10	42-5795
1/2" x 3/4"	8FC12	42-580
3/4" x 1/4"	12FC4	42-5807
3/4" x 1/2"	12FC8	42-581
3/4" x 3/4"	12FC12	42-582
1" x 3/4"	16FC12	42-583
1" x 1"	16FC16	42-584

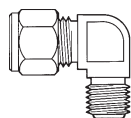

Male Stud Elbow		NPT
1/8" x 1/8"	2ME2	42-529
1/8" x 1/4"	2ME4	42-530
1/4" x 1/8"	4ME2	42-532



I . A . C . Komponenter AB

International Automation Components

P.O Box 60, S-566 22 Habo Phone: +46 (0)36 477 00 Fax: +46 (0)36 477 15

E-mail: habo@iackomp.se www.iackomp.se



Certificate No 488/94

Tube Fittings

Compression Couplings Fractional

- Safelok • Stainless steel SS 316 - 2343 • NPT - American taper thread
- BSPP or BSPT on request

Tube x Thread	Type.No.	Part.No.
Male Stud Elbow		NPT
1/4" x 1/4"	4ME4	42-533
1/4" x 3/8"	4ME6	42-534
1/4" x 1/2"	4ME8	42-535
3/8" x 1/8"	6ME2	42-538
3/8" x 1/4"	6ME4	42-539
3/8" x 3/8"	6ME6	42-540
3/8" x 1/2"	6ME8	42-541
1/2" x 1/4"	8ME4	42-542
1/2" x 3/8"	8ME6	42-543
1/2" x 1/2"	8ME8	42-544
3/4" x 1/2"	12ME8	42-545
3/4" x 3/4"	12ME12	42-546
1" x 3/4"	16ME12	42-547
1" x 1"	16ME16	42-548
Female Stud Elbow		NPT
1/8" x 1/8"	2FE2	42-585
1/8" x 1/4"	2FE4	42-586
1/4" x 1/8"	4FE2	42-588
1/4" x 1/4"	4FE4	42-589
3/8" x 1/8"	6FE2	42-592
3/8" x 1/4"	6FE4	42-593
3/8" x 3/8"	6FE6	42-594
1/2" x 1/4"	8FE4	42-595
1/2" x 3/8"	8FE6	42-596
1/2" x 1/2"	8FE8	42-597
3/4" x 1/2"	12FE8	42-598
3/4" x 3/4"	12FE12	42-599
Male Branch Tee		NPT
1/8" x 1/8"	2TTM2	42-556
1/4" x 1/8"	4TTM2	42-558
1/4" x 1/4"	4TTM4	42-559
3/8" x 1/4"	6TTM4	42-561
1/2" x 3/8"	8TTM6	42-562
1/2" x 1/2"	8TTM8	42-563
Female Branch Tee		NPT
1/8" x 1/8"	2TTF2	42-600
1/4" x 1/8"	4TTF2	42-601
1/4" x 1/4"	4TTF4	42-602
3/8" x 1/4"	6TTF4	42-603
1/2" x 3/8"	8TTF6	42-604
1/2" x 1/2"	8TTF8	42-6042
3/4" x 3/4"	12TTF12	42-605
Male Run Tee		NPT
1/8" x 1/8"	2TMT2	42-549
1/4" x 1/8"	4TMT2	42-550
1/4" x 1/4"	4TMT4	42-551
3/8" x 1/4"	6TMT4	42-553
1/2" x 3/8"	8TMT6	42-554
1/2" x 1/2"	8TMT8	42-555

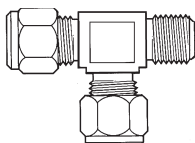
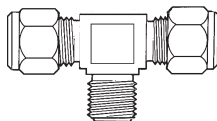
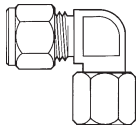
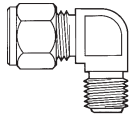

I . A . C . Komponenter AB

International Automation Components

P.O Box 60, S-566 22 Habo Phone: +46 (0)36 477 00 Fax: +46 (0)36 477 15

E-mail: habo@iackomp.se www.iackomp.se



Certificate No 488/94

Tube Fittings

Compression Couplings Fractional

- Safelok • Stainless steel SS 316 - 2343 • NPT - American taper thread
- BSPP or BSPT on request

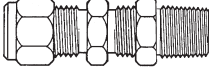
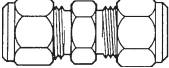
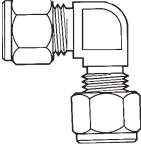
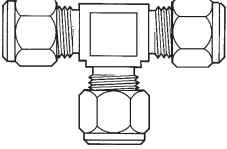
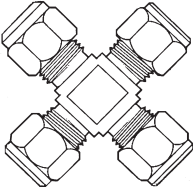
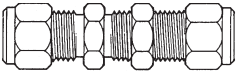
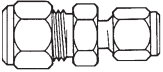
Tube x Thread	Type.No.	Part.No.
Male Bulkhead Connector		
		NPT
	1/8" x 1/8"	2MBH2 42-524
	1/4" x 1/8"	4MBH2 42-525
	1/4" x 1/4"	4MBH4 42-526
	3/8" x 1/4"	6MBH4 42-527
	1/2" x 1/2"	8MBH8 42-528
Equal Union		
	1/8"	2U 42-606
	1/4"	4U 42-608
	3/8"	6U 42-610
	1/2"	8U 42-611
	3/4"	12U 42-612
	1"	16U 42-613
Equal Elbow		
	1/8"	2ELU 42-630
	1/4"	4ELU 42-632
	3/8"	6ELU 42-634
	1/2"	8ELU 42-635
	3/4"	12ELU 42-636
	1"	16ELU 42-637
Union Tee		
	1/8"	2TTT 42-638
	1/4"	4TTT 42-640
	3/8"	6TTT 42-642
	1/2"	8TTT 42-643
	3/4"	12TTT 42-644
	1"	16TTT 42-645
Union Cross		
	1/8"	2UC 42-646
	1/4"	4UC 42-647
	3/8"	6UC 42-648
	1/2"	8UC 42-649
	3/4"	10UC 42-6495
Bulkhead Union		
	1/8"	2BHU 42-623
	1/4"	4BHU 42-625
	3/8"	6BHU 42-627
	1/2"	8BHU 42-628
	3/4"	12BHU 42-629
Reducing Union		
	1/4" x 1/8"	4RU2 42-615
	3/8" x 1/4"	6RU4 42-618
	1/2" x 1/4"	8RU4 42-620
	1/2" x 3/8"	8RU6 42-621
	3/4" x 1/2"	12RU8 42-622
	1" x 3/4"	16RU12 42-6225



I . A . C . Komponenter AB

International Automation Components

P.O Box 60, S-566 22 Habo Phone: +46 (0)36 477 00 Fax: +46 (0)36 477 15

E-mail: habo@iackomp.se www.iackomp.se







Certificate No 488/94

Tube Fittings

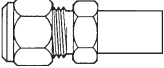
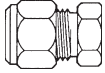
Compression Couplings Fractional

- Safelok • Stainless steel SS 316 - 2343 • NPT - American taper thread
- BSPP or BSPT on request

Tube	Type.No.	Part.No.
Reducing Adaptor		
	1/8" x tube 1/4" OD	2RED4 42-651
	1/8" x tube 3/8" OD	2RED6 42-652
	1/4" x tube 1/8" OD	4RED2 42-654
	1/4" x tube 1/4" OD	4RED4 42-656
	1/4" x tube 3/8" OD	4RED6 42-658
	1/4" x tube 1/2" OD	4RED8 42-659
	3/8" x tube 1/4" OD	6RED4 42-662
	3/8" x tube 1/2" OD	6RED8 42-663
	3/8" x tube 3/4" OD	6RED12 42-664
	1/2" x tube 3/4" OD	8RED12 42-665
	1/2" x tube 1" OD	8RED16 42-666
Blanking End		
	1/8"	2BE 42-667
	1/4"	4BE 42-669
	3/8"	6BE 42-671
	1/2"	8BE 42-672
	3/4"	12BE 42-673
	1"	16BE 42-674
Blanking Plug		
	1/8"	BP2 42-675
	1/4"	BP4 42-677
	3/8"	BP6 42-679
	1/2"	BP8 42-680
	3/4"	BP12 42-681
	1"	BP16 42-682
Compression Nut		
	1/8"	2N 42-689
	1/4"	4N 42-691
	3/8"	6N 42-693
	1/2"	8N 42-694
	3/4"	12N 42-695
	1"	16N 42-696
Front and Back Sealing		
	1/8"	2 RC+FC 42-683
	1/4"	4 RC+FC 42-684
	3/8"	6 RC+FC 42-685
	1/2"	8 RC+FC 42-686
	3/4"	12 RC+FC 42-687
	1"	16 RC+FC 42-688



I . A . C . Komponenter AB

International Automation Components

P.O Box 60, S-566 22 Habo Phone: +46 (0)36 477 00 Fax: +46 (0)36 477 15

E-mail: habo@iackomp.se www.iackomp.se

Pipe Fittings

Pipe fittings – Stainless steel

- Stainless steel SS 316 - 2343 • Male pipe thread KR (BSPT) - European taper
- Female pipe thread R (BSPP) - European parallel • NPT - American taper thread • Also available in other sizes and models



Pipe Thread	Type.No.	Part.No.	
Female Socket		BSPP	NPT
1/8"	R201-DN6	41-073	41-695
1/4"	R201-DN8	41-074	41-696
3/8"	R201-DN10	41-075	41-697
1/2"	R201-DN15	41-076	41-698
3/4"	R201-DN20	41-077	41-699
1"	R201-DN25	41-078	41-700
Hexagon Nipple		BSPT	NPT
1/8"	R207-DN6	41-061	41-600
1/4"	R207-DN8	41-062	41-601
3/8"	R207-DN10	41-063	41-602
1/2"	R207-DN15	41-064	41-603
3/4"	R207-DN20	41-065	41-604
1"	R207-DN25	41-066	41-605
Welding Nipple		BSPT	NPT
1/8"	R208-DN6	41-067	41-715
1/4"	R208-DN8	41-068	41-716
3/8"	R208-DN10	41-069	41-717
1/2"	R208-DN15	41-070	41-718
3/4"	R208-DN20	41-071	41-719
1"	R208-DN25	41-072	41-720
Nipple Tube		BSPT	NPT
1/8"	R210-DN6	41-079	41-637
1/4"	R210-DN8	41-080	41-638
3/8"	R210-DN10	41-081	41-639
1/2"	R210-DN15	41-082	41-640
3/4"	R210-DN20	41-0821	41-641
1"	R210-DN25	41-0822	41-642
Female Tee		BSPP	NPT
1/8"	R221-DN6	41-046	41-645
1/4"	R221-DN8	41-047	41-646
3/8"	R221-DN10	41-048	41-647
1/2"	R221-DN15	41-049	41-648
3/4"	R221-DN20	41-050	41-649
1"	R221-DN25	41-051	41-650
Female Elbow		BSPP	NPT
1/8"	R222-DN6	41-040	41-653
1/4"	R222-DN8	41-041	41-654
3/8"	R222-DN10	41-042	41-655
1/2"	R222-DN15	41-043	41-656
3/4"	R222-DN20	41-044	41-657
1"	R222-DN25	41-045	41-658
Male Hexagon Plug		BSPP	NPT
1/8"	R236-DN6	41-034	41-618
1/4"	R236-DN8	41-035	41-619
3/8"	R236-DN10	41-036	41-620
1/2"	R236-DN15	41-037	41-621
3/4"	R236-DN20	41-038	41-622
1"	R236-DN25	41-039	41-623



I . A . C . Komponenter AB

International Automation Components

P.O Box 60, S-566 22 Habo Phone: +46 (0)36 477 00 Fax: +46 (0)36 477 15

E-mail: habo@iackomp.se www.iackomp.se

Pipe Fittings

Pipe fittings – Stainless steel

- Stainless steel SS 316 - 2343 • Male pipe thread KR (BSPT) - European taper
- Female pipe thread R (BSPP) - European parallel • NPT - American taper thread • Also available in other sizes and models

Pipe Thread	Type.No.	Part.No.	
Male Square Plug			
		BSPT	NPT
1/8"	R238-DN6	41-001	41-730
1/4"	R238-DN8	41-002	41-731
3/8"	R238-DN10	41-003	41-732
1/2"	R238-DN15	41-004	41-733
3/4"	R238-DN20	41-005	41-734
1"	R238-DN25	41-006	41-735
Female Reducing Socket			
		BSPP	NPT
1/4" x 1/8"	R202-DN 8 x 6	41-026	41-705
3/8" x 1/4"	R202-DN10 x 8	41-027	41-706
1/2" x 1/4"	R202-DN15 x 8	41-028	41-707
1/2" x 3/8"	R202-DN15 x 10	41-029	41-708
3/4" x 3/8"	R202-DN20 x 10	41-030	41-709
3/4" x 1/2"	R202-DN20 x 15	41-031	41-710
1" x 1/2"	R202-DN25 x 15	41-032	41-711
1" x 3/4"	R202-DN25 x 20	41-033	41-712
Hexagon Reducing Nipple			
		BSPT	NPT
1/4" x 1/8"	R209-DN 8 x 6	41-013	41-608
3/8" x 1/8"	R209-DN10 x 6	41-014	41-6085
3/8" x 1/4"	R209-DN10 x 8	41-015	41-609
1/2" x 1/8"	R209-DN15 x 6	41-016	41-6095
1/2" x 1/4"	R209-DN15 x 8	41-017	41-610
1/2" x 3/8"	R209-DN15 x 10	41-018	41-611
3/4" x 1/4"	R209-DN20 x 8	41-019	41-6115
3/4" x 3/8"	R209-DN20 x 10	41-020	41-612
3/4" x 1/2"	R209-DN20 x 15	41-021	41-613
1" x 3/8"	R209-DN25 x 10	41-023	41-6135
1" x 1/2"	R209-DN25 x 15	41-024	41-614
1" x 3/4"	R209-DN25 x 20	41-025	41-615
Hexagon Reducing Bush			
		BSP	NPT
1/4" x 1/8"	R211-DN 8 x 6	41-083	41-626
3/8" x 1/8"	R211-DN10 x 6	41-084	41-6265
3/8" x 1/4"	R211-DN10 x 8	41-085	41-627
1/2" x 1/8"	R211-DN15 x 6	41-086	41-628
1/2" x 1/4"	R211-DN15 x 8	41-087	41-629
1/2" x 3/8"	R211-DN15 x 10	41-088	41-630
3/4" x 1/4"	R211-DN20 x 8	41-089	41-6305
3/4" x 3/8"	R211-DN20 x 10	41-090	41-631
3/4" x 1/2"	R211-DN20 x 15	41-091	41-632
1" x 3/8"	R211-DN25 x 10	41-093	41-6325
1" x 1/2"	R211-DN25 x 15	41-094	41-633
1" x 3/4"	R211-DN25 x 20	41-095	41-634
Female Hexagon Cap			
		BSPP	NPT
1/8"	R231-DN6	41-096	41-738
1/4"	R231-DN8	41-097	41-739
3/8"	R231-DN10	41-098	41-740
1/2"	R231-DN15	41-099	41-741
3/4"	R231-DN20	41-100	41-742
1"	R231-DN25	41-101	41-743



I . A . C . Komponenter AB

International Automation Components

P.O Box 60, S-566 22 Habo Phone: +46 (0)36 477 00 Fax: +46 (0)36 477 15

E-mail: habo@iackomp.se www.iackomp.se

Pipe Fittings

Pipe fittings – Stainless steel

- Stainless steel SS 316 - 2343 • Male pipe thread KR (BSPT) - European taper
- Female pipe thread R (BSPP) - European parallel • NPT - American taper thread
- Also available in other sizes and models



Pipe Thread	Type.No.	Part.No.	
Female Round Cap		BSPP	NPT

1/8"	R232-DN6	41-007	-
1/4"	R232-DN8	41-008	-
3/8"	R232-DN10	41-009	-
1/2"	R232-DN15	41-010	-
3/4"	R232-DN20	41-011	-
1"	R232-DN25	41-012	-



Welding Socket		BSPP	NPT
-----------------------	--	-------------	------------

1/8"		41-102	41-723
1/4"		41-103	41-724
3/8"		41-104	41-725
1/2"		41-105	41-726
3/4"		41-106	41-727
1"		41-107	41-728



Hexagon Nut		BSPP	NPT
--------------------	--	-------------	------------

1/8"		41-151	-
1/4"		41-152	-
3/8"		41-153	-
1/2"		41-154	-
3/4"		41-155	-
1"		41-156	-



Hexagon Nipple			
-----------------------	--	--	--

1/8" NPTxBSPP	41-301
1/4" NPTxBSPP	41-302
3/8" NPTxBSPP	41-303
1/2" NPTxBSPP	41-304
3/4" NPTxBSPP	41-305

Table of dimension fractional and DN (dimension normal)			
Dimension		Diameter approx.	
Inch	DN	Male	Female
1/8"	DN06	10 mm	8 mm
1/4"	DN08	13 mm	11 mm
3/8"	DN10	17 mm	14 mm
1/2"	DN15	21 mm	18 mm
3/4"	DN20	27 mm	24 mm
1"	DN25	33 mm	30 mm



I . A . C . Komponenter AB

International Automation Components

P.O Box 60, S-566 22 Habo Phone: +46 (0)36 477 00 Fax: +46 (0)36 477 15

E-mail: habo@iackomp.se www.iackomp.se

Pipe Fittings

Pipe Fittings – Nickelplated Brass

- Male pipe thread KR (BSPT) - European taper
- Female pipe thread R (BSPP) - European parallel
- Also available in other sizes and models

Pipe Thread	Part.No.
Hexagon Socket	
1/8"	40-231
1/4"	40-232
3/8"	40-233
1/2"	40-234
Hexagon nipple	
1/8"	40-201
1/4"	40-202
3/8"	40-203
1/2"	40-204
Hexagon Reducing Nipple	
1/4" x 1/8"	40-211
3/8" x 1/8"	40-212
3/8" x 1/4"	40-213
1/2" x 1/4"	40-214
1/2" x 3/8"	40-215
Hexagon Reducing Bush	
1/4" x 1/8"	40-221
3/8" x 1/8"	40-222
3/8" x 1/4"	40-223
1/2" x 1/8"	40-224
1/2" x 1/4"	40-225
1/2" x 3/8"	40-226
Female Hexagon Reducing Socket	
1/4" x 1/8"	40-241
3/8" x 1/8"	40-242
3/8" x 1/4"	40-243
1/2" x 1/8"	40-244
1/2" x 1/4"	40-245
1/2" x 3/8"	40-246
Hexagon Plug	
M5	40-250
1/8"	40-251
1/4"	40-252
3/8"	40-253
1/2"	40-254
Female Hexagon Cap	
1/8"	40-256
1/4"	40-257
3/8"	40-258
1/2"	40-259



I . A . C . Komponenter AB

International Automation Components

P.O Box 60, S-566 22 Habo Phone: +46 (0)36 477 00 Fax: +46 (0)36 477 15

E-mail: habo@iackomp.se www.iackomp.se

Pipe Fittings

Pipe Fittings – Nickelplated Brass

- Male pipe thread KR (BSPT) - European taper
- Female pipe thread R (BSPP) - European parallel
- Also available in other sizes and models



Pipe Thread	Part.No.
Female Tee	BSPP
1/8"	40-271
1/4"	40-272
3/8"	40-273
1/2"	40-274
Male Branch Tee	BSP
1/8"	40-281
1/4"	40-282
3/8"	40-283
1/2"	40-284
Female Elbow	BSPP
1/8"	40-261
1/4"	40-262
3/8"	40-263
1/2"	40-264
Female x Male Elbow	BSP
1/8"	40-266
1/4"	40-267
3/8"	40-268
1/2"	40-269
Male Run Tee	BSP
1/8"	40-286
1/4"	40-287
3/8"	40-288
1/2"	40-289
Hose Nipple	BSPP
7 mm x 1/8"	40-291
7 mm x 1/4"	40-292
9 mm x 1/4"	40-294
9 mm x 3/8"	40-295
12 mm x 1/4"	40-296
12 mm x 3/8"	40-297
12 mm x 1/2"	40-298
Distance female x male	BSPP
1/8" L=16mm	40-301
1/8" L=36mm	40-302
1/8" L=45mm	40-303
1/4" L=27mm	40-304
1/4" L=43mm	40-305
Plug female hexagon	BSPP
1/8"	40-310
1/4"	40-311
3/8"	40-312
1/2"	40-313



I . A . C . Komponenter AB

International Automation Components

P.O Box 60, S-566 22 Habo Phone: +46 (0)36 477 00 Fax: +46 (0)36 477 15

E-mail: habo@iackomp.se www.iackomp.se

Pipe Fittings

Pipe Fittings – Brass

- Male pipe thread KR (BSPT) - European taper
- Female pipe thread R (BSPP) - European parallel
- Also available in other sizes and models



Pipe Thread		Part.No.
Female Socket		BSPP
1/8"	G06	40-092
1/4"	G08	40-090
3/8"	G10	40-091
1/2"	G15	40-089
Hexagon Nipple		BSPT
1/8"	G06	40-070
1/4"	G08	40-071
3/8"	G10	40-072
1/2"	G15	40-073
Hexagon Reducing Nipple		BSPT
1/4" x 1/8"	G08 x G06	40-013
3/8" x 1/8"	G10 x G06	40-014
3/8" x 1/4"	G10 x G08	40-017
1/2" x 1/8"	G15 x G06	40-018
1/2" x 1/4"	G15 x G08	40-016
1/2" x 3/8"	G15 x G10	40-015
3/4" x 1/2"	G20 x G15	40-021
Nipple Tube		BSPP
1/4"	G08	40-105
3/8"	G10	40-106
1/2"	G15	40-107
Hexagon Reducing Bush		BSP
1/4" x 1/8"	G08xG06	40-083
3/8" x 1/8"	G10xG06	40-081
3/8" x 1/4"	G10xG08	40-085
1/2" x 1/8"	G15xG06	40-086
1/2" x 1/4"	G15xG08	40-087
1/2" x 3/8"	G15xG10	40-088
3/4" x 1/2"	G20xG15	40-082
Female Tee		BSPP
1/8"	G06	40-100
1/4"	G08	40-101
3/8"	G10	40-102
1/2"	G15	40-103
Female Elbow		BSPP
1/8"	G06	40-095
1/4"	G08	40-096
3/8"	G10	40-097
1/2"	G15	40-098
Plug		BSPP
1/8"	G06	40-004
1/4"	G08	40-006
3/8"	G10	40-010
1/2"	G15	40-012



I . A . C . Komponenter AB

International Automation Components

P.O Box 60, S-566 22 Habo Phone: +46 (0)36 477 00 Fax: +46 (0)36 477 15

E-mail: habo@iackomp.se www.iackomp.se

Tubes & Pipes

Analysis-, impulse tubes and protection conduits

- Tubes are delivered in standard lengths of 6 m if nothing else is noted • Tubes up to dim. 16mm, tolerance D4/T3.
- Also available in other sizes and models.
- Stainless steel SS 304 - 2333 and SS 316 - 2343



Size	Part.No.
Welded Calibrated SS 304	
16 x 1.0 mm	33-004
18 x 1.0 mm	33-001
18 x 1.5 mm	33-005
20 x 1.0 mm	33-008
20 x 1.5 mm	33-006
22 x 1.5 mm	33-007
25 x 1.0 mm	33-009
25 x 1.5 mm	33-002
28 x 1.5 mm	33-003
30 x 1.5 mm	33-010
32 x 1.2 mm	33-012
32 x 1.5 mm	33-013
38 x 1.5 mm	33-011
53 x 1.5 mm	33-015
54 x 2.0 mm	33-016
60,3 x 2.0 mm	33-018
Welded Calibrated SS 316	
6 x 0.5 mm coil (approx 220 m)	31-017
6 x 1.0 mm	31-001
8 x 1.0 mm	31-002
10 x 1.0 mm	31-003
12 x 1.0 mm	31-004
12 x 1.5 mm	31-020
14 x 1.0 mm	31-005
15 x 1.0 mm	31-0055
15 x 1.5 mm	31-008
16 x 1.0 mm	31-006
18 x 1.0 mm	31-007
18 x 1.5 mm	31-009
20 x 1.5 mm	31-010
25 x 1.5 mm	31-011
28 x 1.5 mm	31-012
1/4" 13.5 x 2.3 mm	31-100
3/8" 17.2 x 2.3 mm	31-101
1/2" 21.3 x 2.6 mm	31-102
3/4" 26.9 x 2.6 mm	31-103
1" 33.7 x 3.2 mm	31-104
Seamless SS 316	
6 x 1.0 mm	32-001
8 x 1.0 mm	32-006
10 x 1.0 mm	32-002
12 x 1.0 mm	32-003
12 x 1.5 mm	32-004
12 x 2.0 mm	32-012
14 x 2.0 mm	32-014
15 x 1.5 mm	32-007
16 x 2.0 mm	32-005
18 x 2.0 mm	32-018
20 x 2.0 mm	32-020
1/8" 3,18 x 0.71 mm	32-051
1/4" 6.35 x 0.89 mm	32-053
3/8" 9.53 x 1.65 mm	32-055
1/2" 12.7 x 1.24 mm	32-057



I . A . C . Komponenter AB
International Automation Components

P.O Box 60, S-566 22 Habo Phone: +46 (0)36 477 00 Fax: +46 (0)36 477 15
E-mail: habo@iackomp.se www.iackomp.se

Tubes & Pipes

Analysis-, impulse tubes and protection conduits

- Tubes are delivered in standard lengths of 6 m if nothing else is noted • Tubes up to dim. 16mm, tolerance D4/T3.
- Also available in other sizes and models.
- Stainless steel SS 304 - 2333 and SS 316 - 2343



Size	Part.No.
Seamless	13CrMo44
12 x 2.0 mm	34-020
14 x 2.5 mm	34-025
21.3 x 2.6mm 1/2"	34-002
21.3 x 2.9mm 1/2"	34-003
21.3 x 3.2mm 1/2"	34-004
Tube EN AW-6060 T6	Aluminum
18 x 1.0 mm	36-001
18 x 1.5 mm	36-002
20 x 1.0 mm	36-004
20 x 1.5 mm	36-005
22 x 1.5 mm	36-007
25 x 1.5 mm	36-009
28 x 1.5 mm	36-010
30 x 2.0 mm	36-012
32 x 1.2 mm	36-014
32 x 1.5 mm	36-016
40 x 1.5 mm	36-020
50 x 1.5 mm	36-025



I . A . C . Komponenter AB
International Automation Components

P.O Box 60, S-566 22 Habo Phone: +46 (0)36 477 00 Fax: +46 (0)36 477 15
E-mail: habo@iackomp.se www.iackomp.se

Tubes & Pipes

Square tubes and angle bars

- Square section pipes are delivered in standard lengths of 6m
- Flat steel and angle bars are delivered in falling lengths 4-6m
- Stainless steel SS 304 - 2333

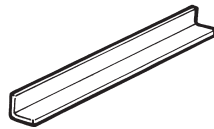
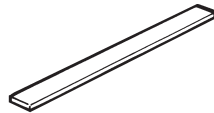
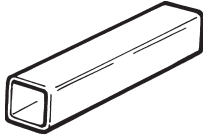

Size	Part.No.
Square Tube	SS 304
20 x 20 x 1.5 mm	83-001
30 x 30 x 1.5 mm	83-003
40 x 40 x 2.0 mm	83-005
50 x 50 x 2.0 mm	83-007
Flat Steel	SS 304
20 x 3 mm	83-072
20 x 4 mm	83-073
25 x 3 mm	83-075
30 x 4 mm	83-079
30 x 5 mm	83-080
40 x 4 mm	83-082
40 x 5 mm	83-083
50 x 5 mm	83-086
Angle Bar	SS 304
20 x 20 x 3 mm	83-120
30 x 30 x 3 mm	83-122
30 x 30 x 4 mm	83-123
40 x 40 x 4 mm	83-124
50 x 50 x 5 mm	83-125



I . A . C . Komponenter AB

International Automation Components

P.O. Box 60, S-566 22 Habo Phone: +46 (0)36 477 00 Fax: +46 (0)36 477 15

E-mail: habo@iackomp.se www.iackomp.se

Tubes & Pipes

Tube accessories

• Also available in other sizes and models.



Size	Part.No.
End Protection	
Plastic	
18.6 mm/PG11 grey	38-111
20.4 mm/PG13 grey	38-114
22.5 mm/PG16 grey	38-115
37.0 mm/PG29 grey	38-123
End Protection	
Plastic	
16 mm grey	38-146
18 mm grey	38-148
20 mm grey	38-150
22 mm grey	38-152
25 mm grey	38-155
28 mm grey	38-158
32 mm grey	38-162
40 mm grey	38-170
End Socket	
SS 304	
18 mm tumbled finish	38-202
28 mm tumbled finish	38-206
18 mm electro-polished finish	*
28 mm electro-polished finish	*
Union Socket	
SS 304	
18 mm tumbled finish	38-212
28 mm tumbled finish	38-216
18 mm electro-polished finish	*
28 mm electro-polished finish	*
End Protection Square	
Plastic	
20 mm female black	38-012
30 mm female black	38-013
40 mm female black	38-016
40 mm male black	38-017
50 mm female black	38-018
Union Socket	
Aluminum	
16 mm inv.	38-601
20 mm inv.	38-603
25 mm inv.	38-605
32 mm inv.	38-608
40 mm inv.	38-609
50 mm inv.	38-610
63 mm inv.	38-611

* - by order



I . A . C . Komponenter AB

International Automation Components

P.O Box 60, S-566 22 Habo Phone: +46 (0)36 477 00 Fax: +46 (0)36 477 15

E-mail: habo@iackomp.se www.iackomp.se

Tubes & Pipes

Tube accessories

• Also available in other sizes and models.



Size	Part.No.
Female union	SS 316
18 mm	38-302
22 mm	38-304
28 mm	38-306
Female elbow 90°	SS 316
18 mm	38-322
22 mm	38-324
28 mm	38-326
Female elbow 45°	SS 316
18 mm	38-342
22 mm	38-344
28 mm	38-346
Male elbow 90°	SS 316
18 mm	38-362
22 mm	38-364
28 mm	38-366



I . A . C . Komponenter AB

International Automation Components

P.O Box 60, S-566 22 Habo Phone: +46 (0)36 477 00 Fax: +46 (0)36 477 15

E-mail: habo@iackomp.se www.iackomp.se

Tube clamps and holders

- Our tube clamps and holders are tumbled to secure soft edges and good finish
- Manufactured of stainless steel SS 304 - 2333 and SS 316 - 2343.

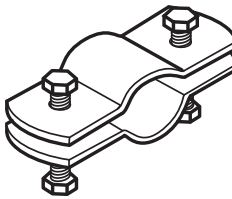
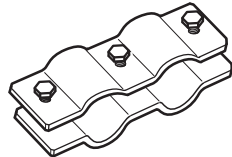
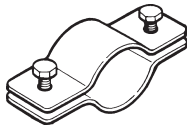
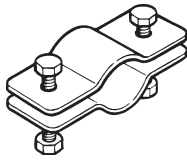

Size	Part.No.	
------	----------	--

Tube clamps parted bolt not incl.	SS 304	SS 316
-----------------------------------	--------	--------

6 mm (5-8 mm)	81-003	81-103
12 mm (9-14 mm)	81-001	81-101
18 mm (15-22 mm)	81-005	81-105
28 mm (23-30 mm)	81-010	81-110

Tube clamps threaded bolt not incl.	SS 304	SS 316
-------------------------------------	--------	--------

6 mm (5-8 mm)	81-033	81-133
12 mm (9-14 mm)	81-031	81-131
18 mm (15-22 mm)	81-035	81-135
28 mm (23-30 mm)	81-040	81-140

Only the threaded half,
12mm 81-032, 18mm 81-037, 28mm 81-042

Tube clamps double threaded bolt not incl.	SS 304	SS 316
--	--------	--------

12 mm (9-14 mm) cc = 32 mm	81-021	*
18 mm (15-22 mm) cc = 42 mm	81-025	*
28 mm (23-30 mm) cc = 50 mm	81-030	*
18 mm + 28 mm (15-22 mm + 23-30 mm)	81-028	*

Tube clamps parted bolt not incl.	SS 304	SS 316
-----------------------------------	--------	--------

DK 31 (29-31 mm)	81-511	-
DK 35 (33-35 mm)	81-513	-
DK 39 (38-39 mm)	81-514	-
DK 43 (40-43 mm)	81-515	-
DK 45 (44-45 mm)	81-517	-
DK 49 (48-49 mm)	81-518	-
DK 56 (53-56 mm)	81-519	-
DK 61 (57-61 mm)	81-520	-
DK 64 (63-64 mm)	81-521	-
DK 71 (70-71 mm)	81-522	-
DK 77 (75-77 mm)	81-523	-
DK 84 (80-84 mm)	81-524	-
DK 90 (88-90 mm)	81-525	-
DK 104 (98-104 mm)	81-526	-
DK 110 (105-110 mm)	81-527	-

Available in dimensions up to 410mm.

Bolts and nuts for tube clamps	SS 304	SS 316
--------------------------------	--------	--------

M6 x 12 mm	-	84-211
M6 x 16 mm	-	84-212
M6 x 20 mm	-	84-213
M6 x 25 mm	-	84-214
M10 x 40 mm	-	84-237
Nut M6	-	84-266
Nut M10	-	84-270

Recommended bolt dimensions					
-----------------------------	--	--	--	--	--

Tube clamps std.	6 mm	12 mm	18 mm	28 mm	
- Bolt	M6 x 12	M6 x 16	M6 x 20	M6 x 25	
Tube clamps threaded		12 mm	18 mm	28 mm	
- Bolt		M6 x 12	M6 x 16	M6 x 20	
Tube clamps std.	DK31	DK35	DK43	DK45	DK56
- Bolt	M10 x 40	M10 x 40	M10 x 40	M10 x 40	M10 x 40



I . A . C . Komponenter AB

International Automation Components

P.O Box 60, S-566 22 Habo Phone: +46 (0)36 477 00 Fax: +46 (0)36 477 15

E-mail: habo@iackomp.se www.iackomp.se

Tube clamps and holders

- Our tube clamps and holders are tumbled to secure soft edges and good finish
- Manufactured of stainless steel SS 304 - 2333 and SS 316 - 2343.

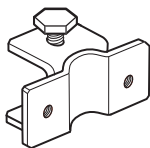
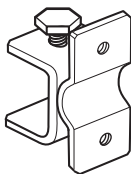
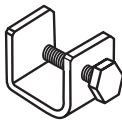
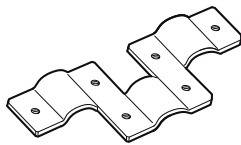
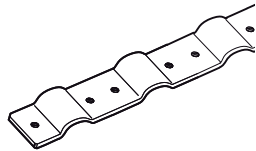
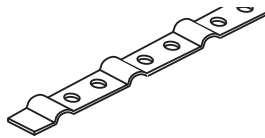

Size	Part.No.	
Tube clamps metre bolt not incl.	SS 304	SS 316
1-hole 12 mm for 28 pipes, cc = 32 mm	81-050	*
2-hole 12 mm for 17 pipes, cc = 55 mm	81-051	*
Multitubeclamp	SS 304	SS 316
12 mm threaded for 8 pipes, cc = 55 mm	81-056	*
18 mm threaded for 7 pipes, cc = 65 mm	81-057	*
28 mm threaded for 6 pipes, cc = 75 mm	81-058	*
Length approx. 0,5 met		
Triple tubeclamps	SS 304	SS 316
12 mm threaded for 3 pipes, cc = 32 mm	81-066	*
18 mm threaded " cc = 42 mm	81-067	*
28 mm threaded " cc = 50 mm	81-068	*
Girder clamp bolt incl.	SS 304	SS 316
20 mm M8 x 25mm	81-352	*
25 mm M8 x 30mm	81-350	*
35 mm M8 x 40mm	81-354	*
Girder clamp with halfclamp	SS 304	SS 316
20 mm x 12mm threaded	81-371	*
20 mm x 18mm threaded	81-372	*
20 mm x 28mm threaded	81-373	*
25 mm x 12mm threaded	81-374	*
25 mm x 18mm threaded	81-375	*
25 mm x 28mm threaded	81-376	*
35 mm x 12mm threaded	81-377	*
35 mm x 18mm threaded	81-378	*
35 mm x 28mm threaded	81-379	*
Girder clamp with halfclamp	SS 304	SS 316
20 mm x 18mm threaded	81-672	*
20 mm x 28mm threaded	81-673	*
25 mm x 18mm threaded	81-675	*
25 mm x 28mm threaded	81-676	*
Bolt with tip	SS 316	
M8 x 25 mm	84-352	
M8 x 30 mm	84-350	
M8 x 40 mm	84-354	

* - by order



I . A . C . Komponenter AB

International Automation Components

P.O Box 60, S-566 22 Habo Phone: +46 (0)36 477 00 Fax: +46 (0)36 477 15

E-mail: habo@iackomp.se www.iackomp.se

Tube clamps and holders

- Our tube clamps and holders are tumbled to secure soft edges and good finish
- Manufactured of stainless steel SS 304 - 2333 and SS 316 - 2343.

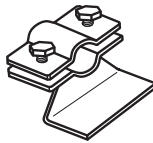
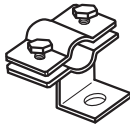
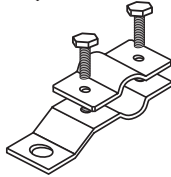
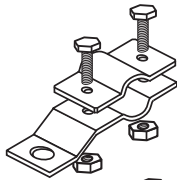

Size	Part.No.	
Wall bracket halfclamp & bolt not incl.	SS 304	SS 316
6 mm unthreaded (5-8 mm)	81-070	-
12 mm unthreaded (9-14 mm)	81-071	-
18 mm unthreaded (15-22 mm)	81-072	-
28 mm unthreaded (23-30 mm)	81-073	-
Wall bracket halfclamp & bolt not incl.	SS 304	SS 316
6 mm threaded (5-8 mm)	81-075	-
12 mm threaded (9-14 mm)	81-076	-
18 mm threaded (15-22 mm)	81-077	-
28 mm threaded (23-30 mm)	81-078	-
Wall bracket half clamp not incl.	SS 304	SS 316
12 mm not threaded half	81-361	*
18 mm not threaded half	81-362	*
28 mm not threaded half	81-363	*
12 mm threaded half	81-366	*
18 mm threaded half	81-367	*
28 mm threaded half	81-368	*
Wall bracket half clamp not incl.	SS 304	SS 316
18 mm not threaded half	81-315	81-415
28 mm not threaded half	81-320	81-420
18 mm threaded half	81-335	81-435
28 mm threaded half	81-340	81-440
Tube support screw incl.	SS 304	SS 316
PK 07 (11-13 mm)	81-221	-
PK 09 (14-16 mm)	81-222	-
PK 11 (17-19 mm)	81-223	-
PK 13,5 (19-21 mm)	81-224	-
PK 16 (21-23 mm)	81-225	-
PK 21 (24-29 mm)	81-226	-
PK 29 (30-38 mm)	81-227	-
PK 36 (39-48 mm)	81-228	-
PK 42 (48-54 mm)	81-229	-
PK 48 (53-61 mm)	81-230	-

* - by order



I . A . C . Komponenter AB

International Automation Components

P.O Box 60, S-566 22 Habo Phone: +46 (0)36 477 00 Fax: +46 (0)36 477 15

E-mail: habo@iackomp.se www.iackomp.se

Tube clamps and holders

- Our tube clamps and holders are tumbled to secure soft edges and good finish
- Manufactured of stainless steel SS 304 - 2333 and SS 316 - 2343.

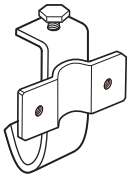
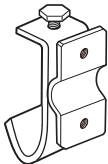
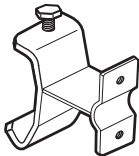
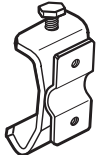
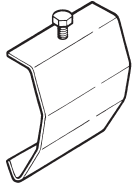

Size	Part.No.	
Bracket "KHZ" bolt incl. M6 x 16	SS 304	SS 316
L= 25 mm, 1 bolt	81-302	81-402
L= 50 mm, 1 bolt	81-301	81-401
L=100 mm, 2 bolts	81-300	81-400
Bracket 25 mm with halfclamp	SS 304	SS 316
12 mm threaded	81-306	*
18 mm threaded	81-307	*
28 mm threaded	81-308	*
Bracket 25 mm with distance halfclamp	SS 304	SS 316
12 mm threaded	81-310	*
18 mm threaded	81-311	*
28 mm threaded	81-312	*
Bracket "MP" bolt incl. M6 x 16	SS 304	SS 316
L= 25 mm, 1 bolt	81-305	*
L= 50 mm, 1 bolt	81-304	*
L=100 mm, 2 bolts	81-303	*
Bracket "MP" with halfclamp	SS 304	SS 316
18 mm threaded	81-607	*
28 mm threaded	81-608	*
Bracket "MP" with halfclamp 90°	SS 304	SS 316
18 mm threaded	81-617	*
28 mm threaded	81-618	*

* - by order



I . A . C . Komponenter AB

International Automation Components

P.O Box 60, S-566 22 Habo Phone: +46 (0)36 477 00 Fax: +46 (0)36 477 15

E-mail: habo@iackomp.se www.iackomp.se

Tube clamps and holders

- Our tube clamps and holders are tumbled to secure soft edges and good finish
- Manufactured of stainless steel SS 304 - 2333 and SS 316 - 2343.



Size	Part.No.	
Pairtubeclamps raised 20 mm	SS 304	SS 316
12 mm unthreaded + 12 mm threaded	81-382	*
18 mm unthreaded + 18 mm threaded	81-385	*
28 mm unthreaded + 28 mm threaded	81-389	*



Pairtubeclamps raised 20 mm	SS 304	SS 316
18 mm unthreaded + 12 mm threaded	81-384	*
28 mm unthreaded + 12 mm threaded	81-387	*
28 mm unthreaded + 18 mm threaded	81-388	*

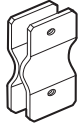

Pairtubeclamps	SS 304	SS 316
12 mm threaded	81-392	*
18 mm threaded	81-395	*
28 mm threaded + 18 mm threaded	81-398	*
28 mm threaded	81-399	*

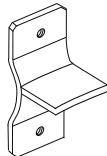

Threaded halfclamp with distance	SS 304	SS 316
12 mm threaded	81-346	*
18 mm threaded	81-347	*
28 mm threaded	81-348	*

* - by order



I . A . C . Komponenter AB





International Automation Components

P.O Box 60, S-566 22 Habo Phone: +46 (0)36 477 00 Fax: +46 (0)36 477 15

E-mail: habo@iackomp.se www.iackomp.se

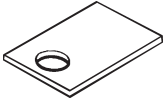
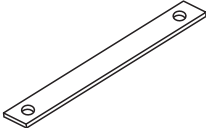
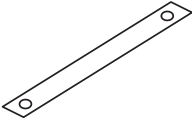
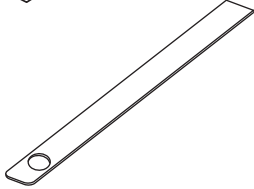
Tube clamps and holders

- Our tube clamps and holders are tumbled to secure soft edges and good finish
- Manufactured of stainless steel SS 304 - 2333 and SS 316 - 2343.

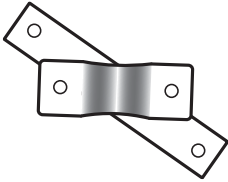
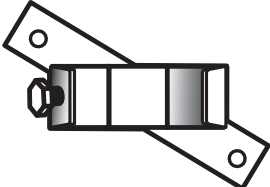
Size	Part.No.		
	Welding bracket mounting hole Ø 9 mm	SS 304	SS 316
	25 mm x 35 mm	81-082	81-182
	25 mm x 40 mm	81-083	81-183
	25 mm x 50 mm	81-080	81-180
	25 mm x 80 mm	81-081	81-181
	Bracket for connection box	SS 304	SS 316
	20x110 mm hole Ø 6 mm	81-090	*
	Plate for label	SS 304	SS 316
	20x100x1 mm hole Ø 3,5 mm	81-095	*
	20x100x2 mm hole Ø 3,5 mm	81-094	*
	Bracket flange	SS 304	SS 316
	40x250 mm hole Ø 21 mm	81-091	*
	40x350 mm hole Ø 18 mm	81-092	*
	Plate	SS 304	SS 316
	For box 90 x 90 x 2 mm (2 hole M4)	81-097	*
	For box 90 x 90 x 2 mm (4 hole M4)	81-096	*
	Without hole 100 x 100 x 2 mm	81-098	*
	Stripe	Plastic	
	200 mm	black	85-103
	200 mm for keyring	white	85-108
	200 mm for keyring	black	85-109
	19 x 19 anker	white	85-114
	29 x 29 anker	white	85-116
	Keyring for label	SS 304	SS 316
	Ø 30 mm	-	85-155
	Bracket for connection box with halfclamp	SS 304	SS 316
	12 mm threaded	81-326	*
	18 mm threaded	81-327	*
	28 mm threaded	81-328	*
	Bracket for connection box with bracket "KHZ"	SS 304	SS 316
	25 mm bracket "KHZ"	81-322	*

* - by order



I . A . C . Komponenter AB

International Automation Components

P.O Box 60, S-566 22 Habo Phone: +46 (0)36 477 00 Fax: +46 (0)36 477 15

E-mail: habo@iackomp.se www.iackomp.se

Holders and condense-pot

- We offer many different types of holders and condense-pots. If you can't find what you are looking for, please contact us.
- Manufactured of stainless steel SS 304 - 2333 and SS 316 - 2343 or galvanized plate

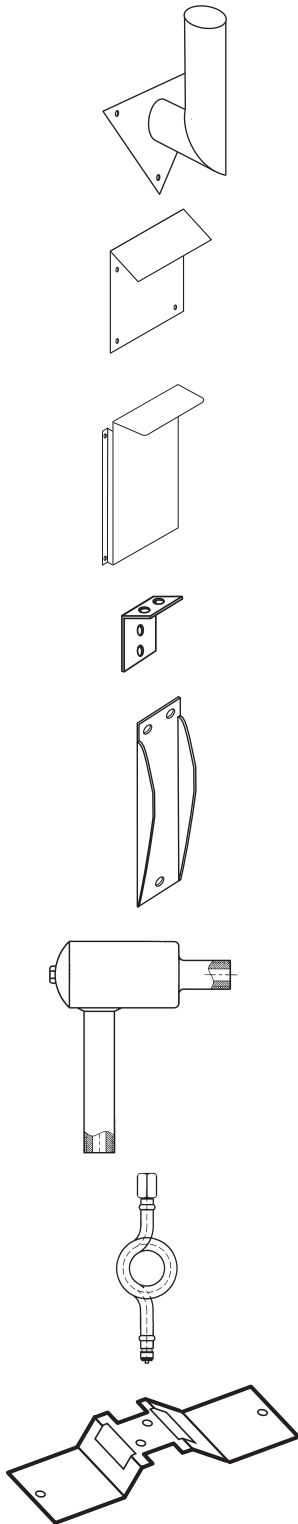

Size	Part.No.	
Bracket DP-cell	SS 304	SS 316
Ø 53 mm	78-810	*
Plate with roof	SS 304	SS 316
190 x 200 x 150 mm	78-861	*
250 x 250 x 150 mm	78-862	*
250 x 400 x 150 mm	78-863	*
Elevated Plate with roof	SS 304	SS 316
250 (300) x 400 x 150 mm	78-814	*
Support for solenoid valve	SS 304	SS 316
35 x 40 x 25 mm	78-823	*
Bracket for manifold Klinger	SS 304	SS 316
64 x 150 mm	65-901	*
Condense-pot PN100	SS 304	SS 316
1/2" R male	*	78-742
1/2" R male with plug	*	78-743
We can make condense-pot in following materials:		
- SIS 1430		
- SIS 2333		
Pressure ranges 16 - 135 bar.		
Syphon PN100 Trumpet Form	SS 304	SS 316
1/2" R Female x Male	-	78-431
Label holder	SS 304	SS 316
30 x 110 mm	85-131	*

* - by order



I . A . C . Komponenter AB

International Automation Components

P.O Box 60, S-566 22 Habo Phone: +46 (0)36 477 00 Fax: +46 (0)36 477 15

E-mail: habo@iackomp.se www.iackomp.se

Tube clamps and holders

- Tube clamps are also available in polyamide or aluminium
- Our holders are tumbled to secure soft edges and good finish.
- Manufactured of stainless steel SS 304 - 2333 and SS 316 - 2343

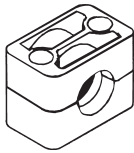

Size	Part.No.	
Tube clamps	Green	Blue
6 mm	82-001	82-051
8 mm	82-002	82-052
10 mm	82-003	82-053
12 mm	82-004	82-054
14 mm	82-0051	*
15 mm	82-0052	*
16 mm	82-0053	*
18 mm	82-006	82-056
20 mm	82-0071	82-0571
22 mm	82-0072	*
25 mm	82-0073	82-0573
28 mm	82-008	82-058
30 mm	82-0091	*
6 mm double	82-011	82-061
8 mm double	82-012	82-062
10 mm double	82-013	82-063
12 mm double	82-014	82-064

Tube clamps	Aluminum
6 mm	82-031
8 mm	82-032
10 mm	82-033
12 mm	82-034
14 mm	82-0351
15 mm	82-0352
16 mm	82-0353
18 mm	82-036
20 mm	82-0371
22 mm	82-0372
25 mm	82-0373
28 mm	82-038
30 mm	82-0391

Cover plate	SS 304
12 mm (6-12 mm) dubbel	82-141
12 mm (6-12 mm) enkel	82-144
18 mm (14-18 mm)	82-146
25 mm (20-25 mm)	82-147
28 mm (28-30 mm)	82-148
42 mm (35-42 mm)	82-149

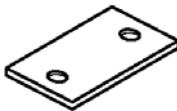

Welding plate even for C-profile 35-40 mm	SS 304
12 mm (6-12 mm) single and double	82-104
18 mm (14-18 mm)	82-106
25 mm (20-25 mm)	82-107
28 mm (28-30 mm)	82-108
42 mm (35-42 mm)	82-109

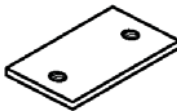

Label plate	SS 304
12+28 mm (6-12 mm + 28-30 mm)	82-128
18 mm (14-18 mm)	82-126
25+42 mm (20-25 mm + 35-42 mm)	82-127

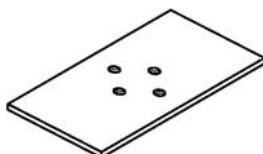

I . A . C . Komponenter AB

International Automation Components

P.O Box 60, S-566 22 Habo Phone: +46 (0)36 477 00 Fax: +46 (0)36 477 15

E-mail: habo@iackomp.se www.iackomp.se

Tube clamps and holders

- Our holders are tumbled to secure soft edges and good finish.
- Manufactured of stainless steel SS 304 - 2333 and SS 316 - 2343

Size	Part.No.	
Mounting plate 1 mountinghole Ø 9 mm SS 304		
12 mm (6-12 mm) single and double	82-134	
18 mm (14-18 mm)	82-136	
25 mm (20-25 mm)	82-137	
28 mm (28-30 mm)	82-138	
42 mm (35-42 mm)	82-139	
Mounting plate 2 mountinghole Ø 9 mm SS 304		
12 mm (6-12 mm) single and double	82-114	
18 mm (14-18 mm)	82-116	
25 mm (20-25 mm)	82-117	
28 mm (28-30 mm)	82-118	
42 mm (35-42 mm)	82-119	
Wallbracket tube clamps SS 304		
12 mm (6-12 mm) även dubbel	82-154	
18 mm (14-18 mm)	82-156	
25 mm (20-25 mm)	82-157	
28 mm (28-30 mm)	82-158	
42 mm (35-42 mm)	82-159	
C-profile SS 316		
40 x 26 x 500 mm	82-171	
28 x 14 x 2000mm, TS-14	82-184	
Nut SS 316		
M6 för C-skena TS-14	82-189	
Female hex.screw SS 316		
M6 x 25 mm	84-454	
M6 x 30 mm	84-455	
M6 x 35 mm	84-4555	
M6 x 40 mm	84-456	
Hexagon bolt SS 316		
M6 x 35 mm	84-2155	
M6 x 40 mm	84-216	
M6 x 45 mm	84-2165	
M6 x 50 mm	84-217	
Tube support polyamide Plastic		
KUPI2 (3-7 mm)	82-221	
KUPI2 (6-13 mm)	82-222	
KUPI2 (12-20 mm)	82-223	
KUPI2 (16-24 mm)	82-224	
KUPI2 (18-30 mm)	82-225	
KUPI2 (27-43 mm)	82-226	
Recommended bolt dimensions for plastic tube clamps		
Tube clamps dim.	Bolt & Screw with coverplate	Hex.screw without coverplate
6-12 mm	M6 x 35	M6 x 25
14-18 mm	M6 x 40	M6 x 30
20-25 mm	M6 x 45	M6 x 35
28-30 mm	M6 x 50	M6 x 40

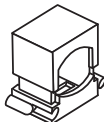
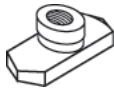
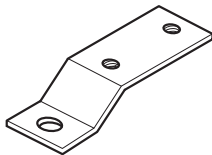
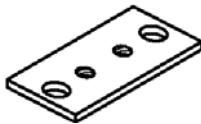
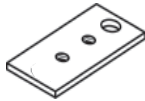

I . A . C . Komponenter AB

International Automation Components

P.O Box 60, S-566 22 Habo Phone: +46 (0)36 477 00 Fax: +46 (0)36 477 15

E-mail: habo@iackomp.se www.iackomp.se



Pneumatic Cables & Tubes

Single - and multi tubes

- Osnaline, if nothing else is noted • Flame-retardent pvc-jacket standard can even be delivered with flame-retardent halogen free LDPE-jacket
- Single tubes are delivered in boxes of 250 m (6 mm), 100 m (8 mm), with jacket 250m.
- Multi tubes are delivered on drums of 500 m

Size	Type.No.	Part.No.
Single tube polyethylene - LDPE halogenfree		
6 x 1.0 mm blue	701	21-001
6 x 1.0 mm red	701	21-002
6 x 1.0 mm black	701	21-003
6 x 1.0 mm green	701	21-004
6 x 1.0 mm yellow	701	21-005
6 x 1.0 mm white	701	21-0065
8 x 1.0 mm black	701	21-009
1/4" x 0.040" black	701	21-007
1/4" x 0.040" blue	701	21-050
1/4" x 0.040" red	701	21-051
1/4" x 0.040" green	701	21-052
1/4" x 0.040" yellow	701	21-053
3/8" x 0.040" black	701	21-0085
3/8" x 0.062" black	701	21-008
Single tube polyamide - PA halogenfree		
4/2.7 mm blue		21-235
4/2.7 mm white		21-236
4/2.7 mm black		21-237
6/4.2 mm blue		21-238
6/4.2 mm white		21-239
6/4.2 mm black		21-240
8/6 mm blue		21-241
8/6 mm white		21-242
8/6 mm black		21-243
10/8 mm blue		21-244
10/8 mm white		21-245
10/8 mm black		21-246
12/10 mm blue		21-247
12/10 mm white		21-248
12/10 mm black		21-249
Single tube polyurethane - PUR halogenfree		
4/2.2 mm blue		21-251
4/2.2 mm white		21-252
6/3.9 mm blue		21-253
6/3.9 mm white		21-254
6/3.9 mm black		21-2545
8/5.7 mm blue		21-255
8/5.7 mm white		21-256
10/7.5 mm blue		21-257
10/7.5 mm white		21-258
12/9 mm blue		21-259
12/9 mm white		21-260
Single tube teflon - PTFE		
6 x 1.0 mm white		21-280
8 x 1.0 mm white		21-281



I . A . C . Komponenter AB

International Automation Components

P.O Box 60, S-566 22 Habo Phone: +46 (0)36 477 00 Fax: +46 (0)36 477 15





E-mail: habo@iackomp.se www.iackomp.se



Pneumatic Cables & Tubes

Single - and multi tubes

- Osnaline, if nothing else is noted • Flame-retardent pvc-jacket standard can even be delivered with flame-retardent halogen free LDPE-jacket
- Single tubes are delivered in boxes of 250 m (6 mm), 100 m (8 mm), with jacket 250m.
- Multi tubes are delivered on drums of 500 m

Size	Type.No.	Part.No.	
Single tube polyvinyl chloride - PV			
	6/4 mm blue	21-271	
	8/6 mm blue	21-273	
	10/8 mm blue	21-275	
	12/10 mm blue	21-277	
Single tube PAUR			
	4/2.5 mm blue	21-2911	
	4/2.5 mm white	21-2912	
	4/2.5 mm black	21-2913	
	6/4 mm blue	21-2921	
	6/4 mm white	21-2922	
	6/4 mm black	21-2923	
	6/4 mm yellow	21-2924	
	8/6 mm blue	21-2931	
	8/6 mm white	21-2932	
	8/6 mm black	21-2933	
	8/6 mm yellow	21-2934	
	10/8 mm blue	21-2941	
	10/8 mm white	21-2942	
	10/8 mm black	21-2943	
	10/8 mm yellow	21-2944	
	12/9 mm blue	21-2951	
	12/9 mm white	21-2952	
	12/9 mm black	21-2953	
Single tube polyethylene/pvc-jacket			
	6 x 1.0 mm blue	7010	21-082
	6 x 1.0 mm black	7010	21-083
	8 x 1.0 mm blue	7010	21-084
	8 x 1.0 mm black	7010	21-085
	10 x 1.0 mm blue	7010	21-086
	10 x 1.0 mm black	7010	21-087
	12 x 1.0 mm blue	7010	21-088
	12 x 1.0 mm black	7010	21-089
Single tube polyamide/pvc-jacket			
	6 x 1.0 mm blue	7030	21-372
	8 x 1.0 mm blue	7030	21-374
	10 x 1.0 mm blue	7030	21-376
	12 x 1.0 mm blue	7030	21-378
Single tube polyamide/LDPE-jacket halogenfree			
	6 x 1.0 mm blue		21-572
	6 x 1.0 mm black		21-573
	8 x 1.0 mm black		21-575
	10 x 1.0 mm blue		21-576
	10 x 1.0 mm black		21-577
	12 x 1.0 mm black		21-579



I . A . C . Komponenter AB

International Automation Components

P.O Box 60, S-566 22 Habo Phone: +46 (0)36 477 00 Fax: +46 (0)36 477 15

E-mail: habo@iackomp.se www.iackomp.se



Pneumatic Cables & Tubes

Single - and multi tubes

- Osnaline, if nothing else is noted • Flame-retardent pvc-jacket standard can even be delivered with flame-retardent halogen free LDPE-jacket
- Single tubes are delivered in boxes of 250 m (6 mm), 100 m (8 mm), with jacket 250m.
- Multi tubes are delivered on drums of 500 m

Size	Type.No.	Part.No.
------	----------	----------

Single tube copper/pvc-jacket



6 x 1.0 mm black	7050	21-071
8 x 1.0 mm black	7050	21-072
10 x 1.0 mm black	7050	21-073
12 x 1.0 mm black	7050	21-074
1/4" x 0.036" black	7050	21-075

Single tube "Dekabon" Synflex 1300 Polyethylene/Aluminum



6 mm svart		21-150
8 mm svart		21-151
10 mm svart		21-152
12 mm svart		21-153

- Polyethylene/Aluminum
- Temperature range -25° C - +80° C

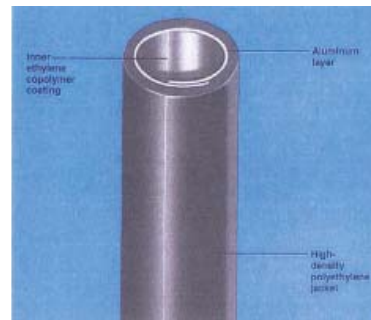

Tube cutter för plastic tube



Plastic 1-15 mm	91-031
Extra edge	91-035

Insert for plastic tube brass



For 6/4 mm tube	43-180
For 8/6 mm tube	43-181
For 10/8 mm tube	43-182
For 12/10 mm tube	43-183

Insert for plastic tube SS 316



For 6/4 mm tube	42-180
For 8/6 mm tube	42-181
For 10/8 mm tube	42-182
For 12/10 mm tube	42-183



I . A . C . Komponenter AB

International Automation Components

P.O Box 60, S-566 22 Habo Phone: +46 (0)36 477 00 Fax: +46 (0)36 477 15

E-mail: habo@iackomp.se www.iackomp.se



Pneumatic Cables & Tubes

Single - and multi tubes

- Osnaline, if nothing else is noted • Flame-retardent pvc-jacket standard can even be delivered with flame-retardent halogen free LDPE-jacket
- Single tubes are delivered in boxes of 250 m (6 mm), 100 m (8 mm), with jacket 250m.
- Multi tubes are delivered on drums of 500 m

Size	Type.No.	Part.No.
------	----------	----------

Multi tube polyethylene/pvc-jacket



2 x 6 mm black flat	7011	21-011
2 x 6 mm black	7011	21-012
2 x 6 mm blue	7011	21-013
2 x 8 mm black	7011	21-016
2 x 8 mm blue	7011	21-018

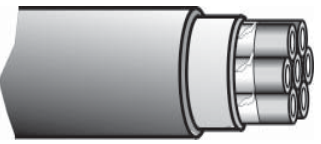

3 x 6 mm black	7011	21-043
3 x 6 mm blue	7011	21-017
7 x 6 mm black	7011	21-024
7 x 6 mm blue	7011	21-023
12 x 6 mm black	7011	21-028
12 x 6 mm blue	7011	21-029
2 x 1/4" black	7011	21-010
2 x 1/4" blue	7011	21-061
2 x 3/8" black	7011	21-015
4 x 1/4" black	7011	21-019
7 x 1/4" black	7011	21-021
12 x 1/4" black	7011	21-026

Multi tube polyamide/pvc-jacket



2 x 6 mm black	7031	21-351
2 x 6 mm green	7031	21-352
2 x 8 mm black	7031	21-354
2 x 8 mm green	7031	21-355
2 x 10 mm black	7031	21-357
2 x 10 mm green	7031	21-358

Electrical-pneumatic cable "IAC" polyethylene/pvc-jacket



1 x 6 mm + PG 2x0.5 black	IAC	21-031
1 x 6 mm + PG 2x0.5 blue	IAC	21-034
1 x 8 mm + PG 2x0.5 blue	IAC	21-032
2 x 6 mm + PG 2x0.5 blue	IAC	21-033
2 x 6 mm + PG 2x0.5 black	IAC	21-035
1 x 6 mm + PG 2x2x0.5 black	IAC	21-0315
1 x 6 mm + PG 2x2x0.5 blue	IAC	21-0345
1 x 8 mm + PG 2x2x0.5 blue	IAC	21-0325
2 x 6 mm + PG 2x2x0.5 blue	IAC	21-0335
2 x 6 mm + PG 2x2x0.5 black	IAC	21-0355
2 x 8 mm + PG 2x2x0.5 blue	IAC	21-0338
1 x 6 mm + 1x2x1,3 blue profibus	IAC	21-046

Electrical-pneumatic cable "IAC" polyamide/pvc-jacket



1 x 6 mm + PG 2x0.5 black	IAC	21-381
1 x 6 mm + PG 2x0.5 green	IAC	21-382
1 x 10 mm + PG 2x0.5 green	IAC	21-386
1 x 6 mm + PG 2x2x0.5 green	IAC	21-3825
1 x 10 mm + PG 2x2x0.5 mm green	IAC	21-3865
1 x 6 mm + KJAAM 2x2x0.5 black	IAC	21-391
2 x 6 mm + KJAAM 2x2x0.5 black	IAC	21-395
2 x 10 mm + ÖLFLEX 4 x 1 black	IAC	21-399



I . A . C . Komponenter AB

International Automation Components

P.O Box 60, S-566 22 Habo Phone: +46 (0)36 477 00 Fax: +46 (0)36 477 15

E-mail: habo@iackomp.se www.iackomp.se



Pneumatic Cables & Tubes

Single - and multi tubes

- Osnaline, if nothing else is noted • Flame-retardent pvc-jacket standard can even be delivered with flame-retardent halogen free LDPE-jacket
- Single tubes are delivered in boxes of 250 m (6 mm), 100 m (8 mm), with jacket 250m.
- Multi tubes are delivered on drums of 500 m

Size	Type.No.	Part.No.
------	----------	----------

Halogen free Multi tube polyethylene/LDPE-jacket

2 x 6 mm blue	7011	21-413
7 x 6 mm black		21-424



Halogen free Multi tube polyamide/LDPE-jacket

2 x 6 mm black	7031	21-512
2 x 6 mm blue	7031	21-513
2 x 8 mm black	7031	21-515
2 x 8 mm blue	7031	21-516
2 x 10 mm blue	7031	21-519



Halogen free Elect.-pneumatic cable "IAC" polyamide/LDPE-jacket

1 x 6 mm + PG 2x0.5 blue	IAC	21-533
1 x 8 mm + PG 2x0.5 blue	IAC	21-536
1 x 10 mm + PG 2x0.5 black	IAC	21-538
2 x 6 mm + PG 2x2x0.5 black	IAC	21-542
2 x 6 mm + PG 2x2x0.5 blue	IAC	21-543
2 x 8 mm + PG 2x2x0.5 blue	IAC	21-546
2 x 10 mm + PG 2x2x0.5 black	IAC	21-548
1 x 6 mm + PG 2x1.0 blue	IAC	21-563
1 x 8 mm + PG 2x1.0 blue	IAC	21-566



Halogen free Elect.-pneumatic cable "IAC" polyethylene/LDPE-jacket

1 x 6 mm + PG 2x0.5 black	IAC	21-432
2 x 6 mm + PG 2x2x0.5 black	IAC	21-442

Steel Wire Braid Hose stainless steel

6 mm pipe end L=300mm	27-103
6 mm pipe end L=500mm	27-105
12 mm pipe end L=300mm	27-113
12 mm pipe end L=500mm	27-115
18 mm pipe end L=300mm	27-123
18 mm pipe end L=500mm	27-125

Can be ordered in any length and with any size on the ends.



I . A . C . Komponenter AB

International Automation Components

P.O Box 60, S-566 22 Habo Phone: +46 (0)36 477 00 Fax: +46 (0)36 477 15

E-mail: habo@iackomp.se www.iackomp.se



Pneumatic Cables & Tubes

Max. Permissible Working Pressure (bar) of Plastic Tubes

Tube size mm	LDPE-Polyethylene			HDPE-Polyethylene			
	20°	40°	60°	20°	40°	60°	75°
4 x 1.0	16	8	4	33	16	8	5
6 x 1.0	10	5	2,5	20	10	5	3
8 x 1.0	7	3,5	1,5	14	7	3,5	2
10 x 1.0	5	2,5	1	11	5,5	2,5	1,5
12 x 1.0	4,5	2	1	9	4,5	2	1
1/4" x 0.040"	10	5	2,5	20	10	5	3
3/8" x 0.040"	6	3	1,5	12	6	3	1,5
3/8" x 0.062"	10	5	2,5	20	10	5	3
1/2" x 0.062"	7	3,5	1,5	14	7	3,5	2

Tube size mm	PA 11/12 w - Polyamide					PTFE - Teflon				
	20°	40°	60°	80°	100°	20°	50°	100°	150°	200°
4 x 1.0	33	24	19	16	13	24	18	13	10	8
6 x 1.0	20	14	11	9,5	7,5	15	11	8	6	5
8 x 1.0	14	10	8	6,5	5,5	11	8,5	6	4,5	3,5
10 x 1.0	11	8	6	5	4	8	6	4	3	2,5
12 x 1.0	9	6,5	5	4	3,5	6,5	5	3,5	2,5	2
1/4" x 0.040"	20	14	11	9,5	7,5	14	11	7,5	5,5	4,5
3/8" x 0.040"	12	8,5	6,5	5,5	4,5	8,5	6,5	4,5	3,5	2,5
3/8" x 0.062"	20	14	11	9,5	7,5	14	11	7,5	5,5	4,5
1/2" x 0.062"	14	10	8	6,5	5,5	10	8	5,5	4	3

- Safety factor 4 against bursting pressure
- Outer jacket PVC YM3 to VDE 0207 - temperature up to 70°C (standard)
- Outer jacket PVC YM4 to VDE 0209 - temperature up to 100°C (by order)
- Outer jacket LDPE - temperature up to 70°C (standard)

Table over outer diameter

Type	Size	Diameter
7011, 7031	2 x 6 mm	17 mm
7011, 7031	2 x 8 mm	23 mm
7031	2 x 10 mm	28 mm
7011	12 x 6 mm	32 mm
IAC	1 x 6 mm + 2 x 0,5 mm	18 mm
IAC	1 x 6 mm + 2 x 2 x 0,5 mm	19 mm
IAC	2 x 6 mm + 2 x 0,5 mm	19 mm
IAC	2 x 6 mm + 2 x 2 x 0,5 mm	19 mm
IAC	1 x 8 mm + 2 x 0,5 mm	21 mm
IAC	2 x 8 mm + 2 x 2 x 0,5 mm	23 mm
IAC	1 x 6 mm + 2 x (2+1) x 0,5 mm	19 mm
IAC	2 x 6 mm + 2 x (2+1) x 0,5 mm	21 mm
IAC	2 x 10 mm + ölflex 4 x 1 mm	28 mm



I . A . C . Komponenter AB

International Automation Components

P.O Box 60, S-566 22 Habo Phone: +46 (0)36 477 00 Fax: +46 (0)36 477 15

E-mail: habo@iackomp.se www.iackomp.se

Plastic Tube Fittings

Push-On Fittings

- Cielle • Nickelplated brass • Push-On fittings with nut
- Male thread BSPT (KR) - European taper pipe thread
- Female thread BSPP (R) - European parallel pipe thread



Tube x Thread	Part.No.
Male Connector	BSPT (KR)
6/4 mm x 1/8"	43-101
6/4 mm x 1/4"	43-102
6/4 mm x 3/8"	43-103
6/4 mm x 1/2"	43-104
8/6 mm x 1/8"	43-106
8/6 mm x 1/4"	43-107
8/6 mm x 3/8"	43-108
10/8 mm x 1/8"	43-109
10/8 mm x 1/4"	43-1091
10/8 mm x 3/8"	43-1092
10/8 mm x 1/2"	43-1093
12/10 mm x 3/8"	43-1095
12/10 mm x 1/2"	43-1096
1/4" x 1/8"	43-001
1/4" x 1/4"	43-002
3/8" x 1/8"	43-006
3/8" x 1/4"	43-007



Male Connector with o-ring	BSPP (R)
6/4 mm x M5	43-1905
6/4 mm x 1/8"	43-190
6/4 mm x 1/4"	43-191
12/10 mm x 3/8"	43-1976

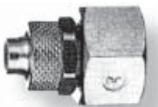

Female Connector	BSPP (R)
6/4 mm x 1/8"	43-130
6/4 mm x 1/4"	43-131
6/4 mm x 3/8"	43-132
8/6 mm x 1/8"	43-135
8/6 mm x 1/4"	43-136
8/6 mm x 3/8"	43-137
10/8 mm x 1/8"	43-1371
10/8 mm x 1/4"	43-1372
10/8 mm x 3/8"	43-1373
10/8 mm x 1/2"	43-1374
12/10 mm x 3/8"	43-1376



Male Elbow	BSPT (KR)
6/4 mm x 1/8"	43-110
6/4 mm x 1/4"	43-111
6/4 mm x 3/8"	43-112
8/6 mm x 1/8"	43-115
8/6 mm x 1/4"	43-116
8/6 mm x 3/8"	43-117
10/8 mm x 1/8"	43-1171
10/8 mm x 1/4"	43-1172
10/8 mm x 3/8"	43-1173
10/8 mm x 1/2"	43-1174
12/10 mm x 3/8"	43-1176
12/10 mm x 1/2"	43-1177



I . A . C . Komponenter AB

International Automation Components

P.O Box 60, S-566 22 Habo Phone: +46 (0)36 477 00 Fax: +46 (0)36 477 15

E-mail: habo@iackomp.se www.iackomp.se

Plastic Tube Fittings

Push-On Fittings

- Cielle • Nickelplated brass • Push-On fittings with nut
- Male thread BSPT (KR) - European taper pipe thread
- Female thread BSPP (R) - European parallel pipe thread



Tube x Thread

Part.No.

Male Swivel Elbow with o-ring

BSPP (R)

6/4 mm x 1/8"	43-118
6/4 mm x 1/4"	43-119
8/6 mm x 1/8"	43-127
8/6 mm x 1/4"	43-128
1/4" x 1/8"	43-018
1/4" x 1/4"	43-019
3/8" x 1/8"	43-027
3/8" x 1/4"	43-028



Female Elbow

BSPP (R)

6/4 mm x 1/8"	43-120
6/4 mm x 1/4"	43-121
8/6 mm x 1/8"	43-125
8/6 mm x 1/4"	43-126
10/8 mm x 1/4"	43-1262
12/10 mm x 3/8"	43-1266



Equal Union

6/4 mm	43-140
8/6 mm	43-141
10/8 mm	43-142
12/10 mm	43-1421
1/4"	43-040
3/8"	43-041



Reducing Union

8/6 mm x 6/4 mm	43-1432
10/8 mm x 6/4 mm	43-1434
10/8 mm x 8/6 mm	43-143



Bulkhead Union

6/4 mm	43-145
8/6 mm	43-146
10/8 mm	43-147
12/10 mm	43-148
1/4"	43-045
3/8"	43-046



Union Tee

6/4 mm	43-165
8/6 mm	43-166
10/8 mm	43-167
12/10 mm	43-168
1/4"	43-065
3/8"	43-066



I . A . C . Komponenter AB

International Automation Components

P.O Box 60, S-566 22 Habo Phone: +46 (0)36 477 00 Fax: +46 (0)36 477 15

E-mail: habo@iackomp.se www.iackomp.se

Plastic Tube Fittings

Push-On Fittings

- Cielle • Nickelplated brass • Push-On fittings with nut
- Male thread BSPT (KR) - European taper pipe thread
- Female thread BSPP (R) - European parallel pipe thread

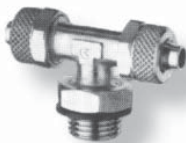
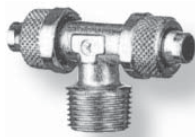

Tube x Thread	Part.No.
Male Branch Tee	BSPT (KR)
6/4 mm x 1/8"	43-150
6/4 mm x 1/4"	43-151
8/6 mm x 1/8"	43-152
8/6 mm x 1/4"	43-153
10/8 mm x 1/8"	43-1531
10/8 mm x 1/4"	43-1532
10/8 mm x 3/8"	43-1533
10/8 mm x 1/2"	43-1534
12/10 mm x 3/8"	43-1536
12/10 mm x 1/2"	43-1537
Male Swivel Branch Tee with teflon	BSPT (KR)
6/4 mm x 1/4"	43-163
Male Run Tee	BSPT (KR)
6/4 mm x 1/8"	43-155
6/4 mm x 1/4"	43-156
6/4 mm x 3/8"	43-157
8/6 mm x 1/8"	43-1581
8/6 mm x 1/4"	43-158
8/6 mm x 3/8"	43-159
10/8 mm x 1/8"	43-160
10/8 mm x 1/4"	43-161
Nut for Cielle-coupling	
6 mm	43-170
8 mm	43-173
10 mm	43-176
12 mm	43-178
1/4"	43-171
3/8"	43-174
Male Connector with teflon	BSPP (R)
6/4 mm x 1/8"	43-301
6/4 mm x 1/4"	43-302
6/4 mm x 3/8"	43-303
8/6 mm x 1/4"	43-307
10/8 mm x 1/8"	43-309
10/8 mm x 1/4"	43-3091
Male Swivel Elbow with teflon	BSPP (R)
6/4 mm x 1/8"	43-310
6/4 mm x 1/4"	43-311
8/6 mm x 1/8"	43-315
8/6 mm x 1/4"	43-316
10/8 mm x 1/4"	43-3172



I . A . C . Komponenter AB

International Automation Components

P.O Box 60, S-566 22 Habo Phone: +46 (0)36 477 00 Fax: +46 (0)36 477 15

E-mail: habo@iackomp.se www.iackomp.se

Plastic Tube Fittings

Fitting

- Legris • Brass
- NPT - American taper pipe thread



Tube x Thread	Part.No.
Male Connector	NPT
6 mm x 1/8"	43-210
6 mm x 1/4"	43-211
10 mm x 1/4"	43-214
Male Elbow	NPT
6 mm x 1/8"	43-216
6 mm x 1/4"	43-217
Male Branch Tee	NPT
6 mm x 1/8"	43-235
6 mm x 1/4"	43-236
Male Run Tee	NPT
6 mm x 1/4"	43-231
Equal Union	
6 mm	43-222
Bulkhead Union	
6 mm	43-225
Union Tee	
6 mm	43-237
Ferrule	
6 mm	43-256
Nut	
6 mm	43-246



I . A . C . Komponenter AB

International Automation Components









P.O Box 60, S-566 22 Habo Phone: +46 (0)36 477 00 Fax: +46 (0)36 477 15

E-mail: habo@iackomp.se www.iackomp.se

Plastic Tube Fittings

Tube fittings

- Manufacture - ©: C.Matic • Stainless steel 316 - 2343
- Push-On fittings with nut
- BSPT (KR) - European taper pipe thread • BSPP (R) - European parallel pipe thread
- Also available in other sizes, models and with other threads

Tube x Thread	Type.No.	Part.No.
Male Connector		BSPT (KR)
	6 mm x 1/8"	CX110618
	6 mm x 1/4"	CX110614
	8 mm x 1/8"	CX110818
	8 mm x 1/4"	CX110814
	10 mm x 1/4"	CX111014
	10 mm x 3/8"	CX111038
Male Elbow		BSPT (KR)
	6 mm x 1/8"	CX140618
	6 mm x 1/4"	CX140614
	8 mm x 1/8"	CX140818
	8 mm x 1/4"	CX140814
	10 mm x 1/4"	CX141014
Equal Union		
	6 mm	CX260606
	8 mm	CX260808
	10 mm	CX261010
Equal Elbow		
	6 mm	CX280006
	8 mm	CX280008
	10 mm	CX280010
Male Branch Tee		BSPT (KR)
	6 mm x 1/8"	CX200618
	6 mm x 1/4"	CX200614
	8 mm x 1/8"	CX200818
	8 mm x 1/4"	CX200814
	10 mm x 1/4"	CX201014
Male Run Tee		BSPT (KR)
	6 mm x 1/8"	CX230618
	6 mm x 1/4"	CX230614
	8 mm x 1/8"	CX230818
	8 mm x 1/4"	CX230814
	10 mm x 1/4"	CX231014
Union Tee		
	6 mm	CX290006
	8 mm	CX290008
	10 mm	CX290010
Nut		
	6 mm	CX100610
	8 mm	CX100812
	10 mm	CX101014



I . A . C . Komponenter AB

International Automation Components

P.O Box 60, S-566 22 Habo Phone: +46 (0)36 477 00 Fax: +46 (0)36 477 15

E-mail: habo@iackomp.se www.iackomp.se

Plastic Tube Fittings

Push-In Fittings

• SR-Sprint • Nickelplated brass • Push-In fitting with grab ring • Can be mounted with protective cap that prevents the ingress of dirt into the connection system • BSPT (KR) - European taper pipe thread • BSPP(R) - European parallel pipe thread • Also available in other sizes, models and with other pipe threads



Tube x Thread	Part.No.
Male Connector	BSPP (R)
4 mm x 1/8"	46-101
4 mm x 1/4"	46-102
6 mm x 1/8"	46-103
6 mm x 1/4"	46-104
8 mm x 1/8"	46-105
8 mm x 1/4"	46-106
8 mm x 3/8"	46-107
10 mm x 1/4"	46-108
10 mm x 3/8"	46-109
10 mm x 1/2"	46-110
12 mm x 1/4"	46-111
12 mm x 3/8"	46-112
12 mm x 1/2"	46-113
4 mm x M5 o-ring	46-1015
6 mm x M5 o-ring	46-1035



Female Connector	BSPP (R)
6 mm x 1/8"	46-117
6 mm x 1/4"	46-118
8 mm x 1/8"	46-119
8 mm x 1/4"	46-120
10 mm x 1/4"	46-1203



Male Elbow	BSPT (KR)
6 mm x 1/8"	46-023
6 mm x 1/4"	46-024
8 mm x 1/8"	46-025
8 mm x 1/4"	46-026
8 mm x 3/8"	46-027
10 mm x 1/4"	46-028
10 mm x 3/8"	46-029
12 mm x 1/4"	46-030
12 mm x 3/8"	46-031

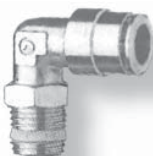

Male Swivel Elbow	BSPP (R)
4 mm x 1/8"	46-121
4 mm x 1/4"	46-122
6 mm x 1/8"	46-123
6 mm x 1/4"	46-124
8 mm x 1/8"	46-125
8 mm x 1/4"	46-126
8 mm x 3/8"	46-127
10 mm x 1/4"	46-128
10 mm x 3/8"	46-129
10 mm x 1/2"	46-130
12 mm x 1/4"	46-131
12 mm x 3/8"	46-132
12 mm x 1/2"	46-133
4 mm x M5 o-ring	46-1215
6 mm x M5 o-ring	46-1235



I . A . C . Komponenter AB

International Automation Components

P.O Box 60, S-566 22 Habo Phone: +46 (0)36 477 00 Fax: +46 (0)36 477 15

E-mail: habo@iackomp.se www.iackomp.se

Plastic Tube Fittings

Push-In Fittings

• SR-Sprint • Nickelplated brass • Push-In fitting with grab ring • Can be mounted with protective cap that prevents the ingress of dirt into the connection system • BSPT (KR) - European taper pipe thread • BSPP(R) - European parallel pipe thread • Also available in other sizes, models and with other pipe threads



Tube x Thread

Part.No.

Male Swivel Branch Tee

BSPP (R)

4 mm x 1/8"	46-141
6 mm x 1/8"	46-143
6 mm x 1/4"	46-144
8 mm x 1/8"	46-145
8 mm x 1/4"	46-146
8 mm x 3/8"	46-147
10 mm x 1/4"	46-148
10 mm x 3/8"	46-149
12 mm x 1/4"	46-150
12 mm x 3/8"	46-151
12 mm x 1/2"	46-152



Male Swivel Run Tee

BSPP (R)

6 mm x 1/8"	46-157
6 mm x 1/4"	46-158
8 mm x 1/8"	46-159
8 mm x 1/4"	46-160
8 mm x 3/8"	46-161
10 mm x 1/4"	46-162
10 mm x 3/8"	46-163
12 mm x 3/8"	46-165



Equal Union

4 mm	46-080
6 mm	46-081
8 mm	46-082
10 mm	46-083
12 mm	46-084



Union Tee

4 mm	46-090
6 mm	46-091
8 mm	46-092
10 mm	46-093
12 mm	46-094



Union Y-Connector

4 mm	46-0945
6 mm	46-095
8 mm	46-096
10 mm	46-097



Plug

4 mm	46-210
6 mm	46-211
8 mm	46-212
10 mm	46-213
12 mm	46-214



I . A . C . Komponenter AB

International Automation Components

P.O Box 60, S-566 22 Habo Phone: +46 (0)36 477 00 Fax: +46 (0)36 477 15

E-mail: habo@iackomp.se www.iackomp.se

Plastic Tube Fittings

Push-In Fittings

• SR-Sprint • Nickelplated brass • Push-In fitting with grab ring • Can be mounted with protective cap that prevents the ingress of dirt into the connection system • BSPT (KR) - European taper pipe thread • BSPP(R) - European parallel pipe thread • Also available in other sizes, models and with other pipe threads



Tube x Thread	Part.No.
---------------	----------

Equal Cross

4 mm	46-231
6 mm	46-232
8 mm	46-233
10 mm	46-234
12 mm	46-235

Bulkhead Union

4 mm	46-180
6 mm	46-181
8 mm	46-182
10 mm	46-183
12 mm	46-184



Protective Cap

4 mm black	46-200
6 mm black	46-201
8 mm black	46-202
10 mm black	46-203
12 mm black	46-204



Reducing Adaptor

4 mm x OD6	46-240
6 mm x OD8	46-241
6 mm x OD10	46-242
6 mm x OD12	46-243
8 mm x OD10	46-244
8 mm x OD12	46-245
10 mm x OD12	46-246



Marker Ring

4 mm red	46-1911
4 mm blue	46-1912
4 mm green	46-1913
6 mm red	46-1921
6 mm blue	46-1922
6 mm green	46-1923
8 mm red	46-1931
8 mm blue	46-1932
8 mm green	46-1933
10 mm red	46-1941
10 mm blue	46-1942
10 mm green	46-1943
12 mm red	46-1951
12 mm blue	46-1952
12 mm green	46-1953



I . A . C . Komponenter AB

International Automation Components

P.O Box 60, S-566 22 Habo Phone: +46 (0)36 477 00 Fax: +46 (0)36 477 15

E-mail: habo@iackomp.se www.iackomp.se

Plastic Tube Fittings

Push-In Fittings

- Legris • Polyamide with pipethread in nickelplated brass
- Push-In fittings with grab ring • Also available in other sizes, models and with other pipe threads

Tube x Thread	Part.No.	
Male Connector	BSPT	BSPP
6 mm x 1/8"	45-003	45-103
6 mm x 1/4"	45-004	45-104
8 mm x 1/8"	45-005	45-105
8 mm x 1/4"	45-006	45-106
8 mm x 3/8"	45-007	45-107
10 mm x 1/4"	45-008	45-108
10 mm x 3/8"	45-009	-
Female Connector	BSPT	BSPP
6 mm x 1/8"	-	45-117
6 mm x 1/4"	-	45-118
8 mm x 1/8"	-	45-119
8 mm x 1/4"	-	45-120
Male Swivel Elbow	BSPT	BSPP
6 mm x 1/8"	45-023	45-123
6 mm x 1/4"	45-024	45-124
8 mm x 1/8"	45-025	45-125
8 mm x 1/4"	45-026	45-126
8 mm x 3/8"	45-027	45-127
10 mm x 1/4"	45-028	45-128
10 mm x 3/8"	45-029	45-129
Male Swivel Branch Tee	BSPT	BSPP
6 mm x 1/8"	45-043	45-143
6 mm x 1/4"	45-044	45-144
8 mm x 1/8"	45-045	45-145
8 mm x 1/4"	45-046	45-146
8 mm x 3/8"	45-047	45-147
Male Swivel Run Tee	BSPT	BSPP
6 mm x 1/8"	45-057	45-157
6 mm x 1/4"	45-058	45-158
8 mm x 1/8"	45-059	45-159
8 mm x 1/4"	45-060	45-160
8 mm x 3/8"	45-061	45-161
Male Swivel Y-Connector	BSPT	BSPP
6 mm x 1/8"	45-073	45-173
6 mm x 1/4"	45-074	45-174
8 mm x 1/8"	45-075	45-175
8 mm x 1/4"	45-076	45-176
Equal Union		
6 mm		45-081
8 mm		45-082
10 mm		45-083
Equal Elbow		
6 mm		45-086
8 mm		45-087
10 mm		45-088



I . A . C . Komponenter AB

International Automation Components

P.O Box 60, S-566 22 Habo Phone: +46 (0)36 477 00 Fax: +46 (0)36 477 15

E-mail: habo@iackomp.se www.iackomp.se

Plastic Tube Fittings

Push-In Fittings

- Legris • Polyamide with pipethread in nickelplated brass
- Push-In fittings with grab ring • Also available in other sizes, models and with other pipe threads



Tube x Thread	Part.No.
Union Tee	
6 mm	45-091
8 mm	45-092
10 mm	45-093
Union Y-Connector	
6 mm	45-095
8 mm	45-096
Plug-In Y-Connector	
6 mm	45-098
8 mm	45-099
Plug-In Elbow	
6 mm	45-221
8 mm	45-222
Air Manifold 2 tubes	
6 mm	45-181
8 mm	45-182
Air Manifold 3 tubes	
6 mm	45-186
8 mm	45-187
Plug	
6 mm	45-211
8 mm	45-212
10 mm	45-213
Reducing Union	
8 mm x 6 mm	45-227
10 mm x 8 mm	45-229



I . A . C . Komponenter AB

International Automation Components

P.O Box 60, S-566 22 Habo Phone: +46 (0)36 477 00 Fax: +46 (0)36 477 15

E-mail: habo@iackomp.se www.iackomp.se

Plastic Tube Fittings

Push-In Fittings

- Swift Fit • Technopolymer with pipethread in nickelplated brass
- Push-In fittings with grab ring • Also available in other sizes, models and with other pipe threads



Tube x Thread	Part.No.
Male Connector	
6 mm x 1/8"	45-303
6 mm x 1/4"	45-304
10 mm x 1/4"	45-308
Male Swivel Elbow	
6 mm x 1/8"	45-323
6 mm x 1/4"	45-324
10 mm x 1/4"	45-328
Male Swivel Branch Tee	
6 mm x 1/8"	45-343
6 mm x 1/4"	45-344
10 mm x 1/4"	45-348
Equal Union	
6 mm	45-381
10 mm	45-383
Union Tee	
6 mm	45-391
10 mm	45-393



I . A . C . Komponenter AB

International Automation Components

P.O Box 60, S-566 22 Habo Phone: +46 (0)36 477 00 Fax: +46 (0)36 477 15

E-mail: habo@iackomp.se www.iackomp.se

Tube Fittings

Push-In Fittings

- Manufacture - ©: C.Matic • Stainless steel SS 316 - 2343
- Push-in fitting with grab ring for plastic or metal tube
- BSPT (KR) - European taper pipe thread • BSPP (R) - European parallel pipe thread
- Also available in other sizes, models and with other threads



Tube x Thread	Type.No.	Part.No.
Male Connector		BSPT (KR)

6 mm x 1/8"	MX110618	47-003
6 mm x 1/4"	MX110614	47-004
8 mm x 1/8"	MX110818	47-005
8 mm x 1/4"	MX110814	47-006
10 mm x 1/4"	MX111014	47-008
10 mm x 3/8"	MX111038	47-009



Male Connector		BSPP (R)
-----------------------	--	-----------------

6 mm x 1/8"	MX120618	47-013
6 mm x 1/4"	MX120614	47-014
8 mm x 1/8"	MX120818	47-015
8 mm x 1/4"	MX120814	47-016



Male Swivel Elbow		BSPT (KR)
--------------------------	--	------------------

6 mm x 1/8"	MX150618	47-023
6 mm x 1/4"	MX150614	47-024
8 mm x 1/8"	MX150818	47-025
8 mm x 1/4"	MX150814	47-026
10 mm x 1/4"	MX151014	47-028
10 mm x 3/8"	MX151038	47-029



Male Swivel Elbow		BSPP (R)
--------------------------	--	-----------------

6 mm x 1/8"	MX160618	47-033
6 mm x 1/4"	MX160614	47-034
8 mm x 1/8"	MX160818	47-035
8 mm x 1/4"	MX160814	47-036



Male Swivel Branch Tee		BSPT (KR)
-------------------------------	--	------------------

6 mm x 1/8"	MX200618	47-043
6 mm x 1/4"	MX200614	47-044
8 mm x 1/8"	MX200818	47-045
8 mm x 1/4"	MX200814	47-046
10 mm x 1/4"	MX201014	47-048
10 mm x 3/8"	MX201038	47-049



Male Swivel Branch Tee		BSPP (R)
-------------------------------	--	-----------------

6 mm x 1/8"	MX210618	47-053
6 mm x 1/4"	MX210614	47-054
8 mm x 1/8"	MX210818	47-055
8 mm x 1/4"	MX210814	47-056



Bulkhead Union		
-----------------------	--	--

6 mm	MX270606	47-071
8 mm	MX270808	47-072
10 mm	MX271010	47-073



I . A . C . Komponenter AB

International Automation Components

P.O Box 60, S-566 22 Habo Phone: +46 (0)36 477 00 Fax: +46 (0)36 477 15

E-mail: habo@iackomp.se www.iackomp.se

Tube Fittings

Push-In Fittings

- Manufacture - ©: C.Matic • Stainless steel SS 316 - 2343
- Push-in fitting with grab ring for plastic or metal tube
- BSPT (KR) - European taper pipe thread • BSPP (R) - European parallel pipe thread
- Also available in other sizes, models and with other threads



Tube x Thread	Type.No.	Part.No.
Reducing Adaptor		
6 mm x OD8	MX250608	47-077
8 mm x OD10	MX250810	47-078
Equal Union		
6 mm	MX260606	47-081
8 mm	MX260808	47-082
10 mm	MX261010	47-083
Equal Elbow		
6 mm	MX280600	47-086
8 mm	MX280800	47-087
10 mm	MX281000	47-088
Union Tee		
6 mm	MX290600	47-091
8 mm	MX290800	47-092
10 mm	MX291000	47-093



I . A . C . Komponenter AB

International Automation Components

P.O Box 60, S-566 22 Habo Phone: +46 (0)36 477 00 Fax: +46 (0)36 477 15

E-mail: habo@iackomp.se www.iackomp.se

Plastic Tube Fittings

Push-On Fittings

- AH • For plastic tube • Polyamide • Push-On fitting with barb lock alt. hose clip
- Also available in other sizes for tube up to inside Ø 19 mm and in other models

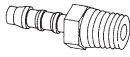

Tube x Thread	Type.No.	Part.No.
Male Connector		BSPT (KR)

4 mm x 1/8"	GES 4-R 1/8	43-500
4 mm x 1/4"	GES 4-R 1/4	43-501
6 mm x 1/8"	GES 6-R 1/8	43-502
6 mm x 1/4"	GES 6-R 1/4	43-503

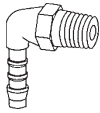

Male Elbow		BSPT (KR)
-------------------	--	------------------

4 mm x 1/8"	WES 4-R 1/8	43-510
4 mm x 1/4"	WES 4-R 1/4	43-511
6 mm x 1/8"	WES 6-R 1/8	43-512
6 mm x 1/4"	WES 6-R 1/4	43-513

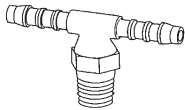

Male Branch Tee		BSPT (KR)
------------------------	--	------------------

4 mm x 1/8"	TES 4-R 1/8	43-550
4 mm x 1/4"	TES 4-R 1/4	43-551
6 mm x 1/8"	TES 6-R 1/8	43-552
6 mm x 1/4"	TES 6-R 1/4	43-553

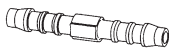

Equal Union		
--------------------	--	--

4 mm	GS 4	43-520
6 mm	GS 6	43-521



Equal Elbow		
--------------------	--	--

4 mm	WS 4	43-530
6 mm	WS 6	43-531

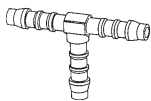

Union Tee		
------------------	--	--

4 mm	TS 4	43-540
6 mm	TS 6	43-541

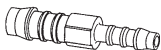

Reducing Union		
-----------------------	--	--

6 x 4 mm	GRS 6-4	43-526
----------	---------	--------

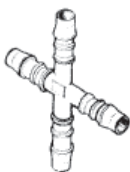

Union Cross		
--------------------	--	--

4 mm	KS 4	43-545
6 mm	KS 6	43-546



I . A . C . Komponenter AB

International Automation Components

P.O Box 60, S-566 22 Habo Phone: +46 (0)36 477 00 Fax: +46 (0)36 477 15

E-mail: habo@iackomp.se www.iackomp.se

Plastic Tube Fittings

Quick Release Coupling

- Camozzi • Nickelplated brass • BSPP(R) -European parallel pipe thread
- Available in standard and mini models



Type x Thread	Type.No.	Part.No.
Female with male thread		BSPP (R)
Hona x 1/4"	5081	43-851
Hona x 3/8"	5081	43-852
Hona x 1/2"	5081	43-853
Female with female thread		BSPP (R)
Hona x 1/4"	5083	43-856
Hona x 3/8"	5083	43-857
Hona x 1/2"	5083	43-858
Male with male thread		BSPP (R)
Hane x 1/4"	5180	43-871
Hane x 3/8"	5180	43-872
Hane x 1/2"	5180	43-873
Male with female thread		BSPP (R)
Hane x 1/4"	5380	43-876
Hane x 3/8"	5380	43-877
Hane x 1/2"	5380	43-878
Female Mini with male thread		BSPP (R)
Hona x 1/8"	5051	43-800
Hona x 1/4"	5051	43-801
Female Mini with female thread		BSPP (R)
Hona x 1/8"	5053	43-805
Hona x 1/4"	5053	43-806
Female Mini with nipple		
Hona x 6 mm nipple	5056	43-815
Hona x 9 mm nipple	5056	43-816
Female Mini for tube		
Hona x 6/4 mm tube	5054	43-810
Hona x 8/6 mm tube	5054	43-811
Male Mini with male thread		BSPP (R)
Hane x 1/8"	5150	43-820
Hane x 1/4"	5150	43-821
Male Mini with female thread		BSPP (R)
Hane x 1/8"	5350	43-825
Hane x 1/4"	5350	43-826
Male Mini for tube		
Hane x 6/4 mm tube	5450	43-830
Hane x 8/6 mm tube	5450	43-831



I . A . C . Komponenter AB

International Automation Components

P.O Box 60, S-566 22 Habo Phone: +46 (0)36 477 00 Fax: +46 (0)36 477 15

E-mail: habo@iackomp.se www.iackomp.se

Air Distributors

Air distributors and accessories

- IAC • Square or hexagon profile in aluminium with ball valve in nickelplated brass • Standard CC-measure 35 mm 1/4", 50 mm 1/2" • We can produce air distributors with other outlets or other CC-measures on your request.

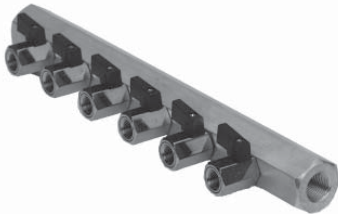

Size	Part.No.
Air distributors 1/4" with mini valves	BSP
1 x 4 outlets 1/8"	24-204
1 x 6 outlets 1/8"	24-206
1 x 8 outlets 1/8"	24-208
1 x 10 outlets 1/8"	24-210
1 x 12 outlets 1/8"	24-212
1 x 15 outlets 1/8"	24-215
Ball valve Mini nickelplated brass	BSP
1/8" male x female	61-020
1/4" male x female	61-021
1/8" male x 6 mm tube	61-030
1/4" male x 6 mm tube	61-031
Air distributor 1/2" with valves	BSP
1 x 6 outlets 1/4"	24-006
1 x 8 outlets 1/4"	24-008
1 x 10 outlets 1/4"	24-010
1 x 12 outlets 1/4"	24-011
2 x 6 outlets 1/4"	24-012
2 x 12 outlets 1/4", cc=40 mm	24-021
1 x 15 outlets 1/4"	24-013
Air distributor 3/4" with valves	BSP
1 x 15 outlets 1/4"	24-035
1 x 20 outlets 1/4"	24-040
Ball valve nickelplated brass	BSP
1/4" male x female	61-001
3/8" male x female	61-002
1/2" male x female	61-003
Air distributor 1/2" stainless without valves	BSP
1 x 6 outlets 1/4"	24-052
1 x 8 outlets 1/4"	24-053
1 x 10 outlets 1/4"	24-054
Ball valve Mini stainless	BSP
1/4" inv.	61-1502
Hexagonal bracket zink plated steel	
1/2"	24-061
3/4"	24-063
Bracket stainless	
1/2" for air distributor	24-060



I . A . C . Komponenter AB
International Automation Components

P.O Box 60, S-566 22 Habo Phone: +46 (0)36 477 00 Fax: +46 (0)36 477 15
E-mail: habo@iackomp.se www.iackomp.se

Air Distributors

Air distributors

- Bex • Anodized aluminium air distributor with built-in on/off valves
- Other dimensions - on request.

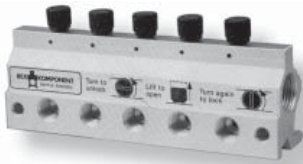

Size	Type.No.	Part.No.
------	----------	----------

Air distributor VL		BSP	NPT
3 pcs outlets 1/4"	L=111 mm VL-3	24-128	*
5 pcs outlets 1/4"	L=166 mm VL-5	24-130	*
6 pcs outlets 1/4"	L=194 mm VL-6	24-131	*
8 pcs outlets 1/4"	L=249 mm VL-8	24-133	*
10 pcs outlets 1/4"	L=303 mm VL-10	24-135	*
12 pcs outlets 1/4"	L=358 mm VL-12	24-137	*
15 pcs outlets 1/4"	L=441 mm VL-15	24-140	*

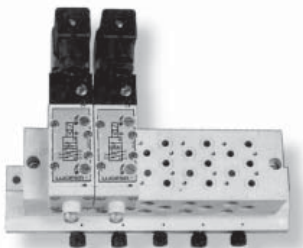

Air distributor LL/LB		BSP
-----------------------	--	-----

For Lucifer 341L L=252 mm	LL/LB-5-B	24-145
For Lucifer 341L L=288 mm	LL/LB-6-B	24-146
For Lucifer 341L L=360 mm	LL/LB-8-B	24-147
For Lucifer 341L L=432 mm	LL/LB-10-B	24-148

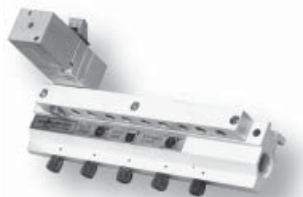

Air distributor VDOL		BSP
----------------------	--	-----

For I/P-trans. VDO L=166 mm	VDOL-5	24-150
For I/P-trans. VDO L=194 mm	VDOL-6	24-151
For I/P-trans. VDO L=249 mm	VDOL-8	24-153
For I/P-trans. VDO L=303 mm	VDOL-12	24-155

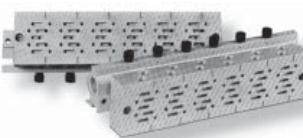

Air distributor for solenoid valves ISO 5599/1		BSP
--	--	-----

For 5 pcs ISO 1 L=272 mm	IL/IM-1AH-5	24-160
For 6 pcs ISO 1 L=315 mm	IL/IM-1AH-6	24-161
For 8 pcs ISO 1 L=401 mm	IL/IM-1AH-8	24-162
For 5 pcs ISO 2 L=347 mm	IL/IM-2A-5	24-171
For 6 pcs ISO 2 L=390 mm	IL/IM-2A-6	24-172
For 8 pcs ISO 2 L=502 mm	IL/IM-2A-8	24-174

Cover plate	
-------------	--

LBP for LB-list	24-180
ILP-1 for IL-list ISO 1	24-182
ILP-2 for IL-list ISO 2	24-183

Block support plastic	
-----------------------	--

46 x 60 for Lucifer 341P21	63-921
55 x 70 for Lucifer 341P22	63-922

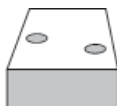

* - by order



I . A . C . Komponenter AB

International Automation Components

P.O Box 60, S-566 22 Habo Phone: +46 (0)36 477 00 Fax: +46 (0)36 477 15

E-mail: habo@iackomp.se www.iackomp.se

Air Distributors

Air distributors

- Camozzi
- Air distributors in technopolymer with push-in fitting in metal



Size	Part.No.
Air distributor Y	
6 mm + 2 x 4 mm	24-351
8 mm + 2 x 6 mm	24-352
Air distributor Straight	
6 mm + 3 x 4 mm	24-356
8 mm + 3 x 6 mm	24-357
Air distributor Cross	
6 mm + 4 x 4 mm	24-361
8 mm + 4 x 6 mm	24-362
Air distributor aluminium	
1/4" BSP + 4 x 1/8" BSP	24-304



I . A . C . Komponenter AB

International Automation Components

P.O Box 60, S-566 22 Habo Phone: +46 (0)36 477 00 Fax: +46 (0)36 477 15

E-mail: habo@iackomp.se www.iackomp.se

Filters, regulators and lubricators

- Camozzi, if nothing else is noted.
- Also available in other dimensions and models.



Size	Type.No.	Part.No.
Regulator Mini		
1/8" 0,5-10 bar	M008-R00	22-155



Regulator		
------------------	--	--

1/4" 0,5-10 bar	MC 104-R00	22-165
1/2" 0,5-10 bar	MC 202-R00	22-175



Regulator		
------------------	--	--

1" 0,5-10 bar	C401-R00	22-185
---------------	----------	--------



Filter Regulator		
-------------------------	--	--

1/4" 25µm 0,5-10 bar	MC 104-D00	22-161
1/2" 25µm 0,5-10 bar	MC 202-D00	22-171



Filter		
---------------	--	--

1/4" 25µm	MC 104-F00	22-163
1/2" 25µm	MC 202-F00	22-173



Lubricator		
-------------------	--	--

1/4"	MC 104-L00	22-167
1/2"	MC 202-L00	22-177



Soft start and on/off valve		
------------------------------------	--	--

1/4" Soft start	MC 104-AV	22-169
1/4" Electric valve	MC 104-V16	22-1691
1/4" Pneumatic valve	MC 104-V36	22-1692



Regulator "Norgren"		BSP
----------------------------	--	------------

1/4" 0-7 bar	R07-200-RNKG	22-008
1/4" 0-7 bar with filter	B07-200-M3KG	22-050



Regulator "Bellofram"		NPT
------------------------------	--	------------

1/4" 0-30 PSI	T-50	22-225
1/2" 0-30 PSI	T-70	22-230



Regulator "Fairchild"		NPT
------------------------------	--	------------

3/8" 1-60 PSI	10243	22-235
---------------	-------	--------



I . A . C . Komponenter AB

International Automation Components

P.O Box 60, S-566 22 Habo Phone: +46 (0)36 477 00 Fax: +46 (0)36 477 15

E-mail: habo@iackomp.se www.iackomp.se

Pneumatic Valves

Pneumatic valves and accessories

• Camozzi • Also available in other dimensions and models.



Size	Type.No.	Part.No.
------	----------	----------

Pressure Switch

1/8" 1-10 bar	PM-11-NA+CAP	25-001
1/8" 1-10 bar	PM-11-NC+CAP	25-002



Valves solenoid not incl.

24 mm flange - 3/2	A231-BC2	25-201
1/8" - 2/2	A321-1C2	25-211
1/8" - 3/2	A331-1C2	25-212



Electro Operated Valves solenoid incl.

1/8" - 5/2 - 24 VDC	E531-16-P13	25-215
1/8" - 5/2 - 24 VDC	E531-16-PN3	25-216
1/4" - 5/2 - 24 VDC	E551-16-PN3	25-217
1/4" - 5/2 - 24 VDC	E551-16-P13	25-218



Electro Operated Valves solenoid not incl.

1/8" - 3/2	338-015-02	25-221
1/8" - 5/2	358-011-02	25-231
1/8" - 5/2	358-015-02	25-232
1/4" - 5/2	354-011-02	25-241
1/4" - 5/2	354-015-02	25-242
1/4" - 5/2	454-011-22	25-245
1/4" - 5/2	454-015-22	25-246



Solenoid

12 VDC / 24 VAC	U7H	25-271
24 VDC / 48 VAC	U77	25-272
230 / 240 VAC	U7J	25-273



Connectors

15 mm	125-800	25-288
20 mm	122-800	25-283
20 mm lightdiode 24 V	122-701	25-281
20 mm lightdiode 230 V	122-703	25-282
26 mm	124-800	25-287
26 mm lightdiode 24 V	124-701	25-286



I . A . C . Komponenter AB

International Automation Components

P.O Box 60, S-566 22 Habo Phone: +46 (0)36 477 00 Fax: +46 (0)36 477 15

E-mail: habo@iackomp.se www.iackomp.se

Pneumatic Valves

Pneumatic valves and accessories

• Camozzi • Also available in other dimensions and models.

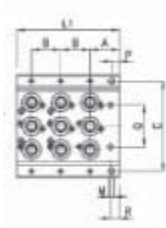

Size	Type.No.	Part.No.
------	----------	----------

Basic Module Series 3

1/8" - 3/8"	CNVL-3H2	25-311
1/8" - 3/8"	CNVL-3H3	25-312
1/4" - 3/8"	CNVL-4H2	25-321
1/4" - 3/8"	CNVL-4H3	25-322

Terminal Module Series 3

1/8" - 3/8"	CNVL-3H	25-310
1/4" - 3/8"	CNVL-4H	25-320

Blanking Plate Series 3

1/8"	CNVL/1	25-305
1/4"	CNVL/4	25-306

Blanking Plug Series 3

1/8"	TCNVL/3	25-301
1/4"	TCNVL/5	25-302

Pneumatically Operated Valves

1/8" - 3/2	338-033	26-021
1/8" - 3/2	338-035	26-022
1/8" - 5/2	358-033	26-031
1/8" - 5/2	358-035	26-032
1/4" - 5/2	354-033	26-041
1/4" - 5/2	354-035	26-042
1/4" - 5/2	454-33	26-045
1/4" - 5/2	454-35	26-046
1/2" - 5/2	452C-35	26-051



Mechanically Operated Valves

M5 - 3/2	235-955	26-102
1/8" - 3/2	358-955	26-131



Manually Operated Console Minivalves

4 mmS - 3/2	234-000	26-201
M5 - 3/2	235-000	26-202
4 mmS - 5/3	284-000	26-203



Actuators for Console Minivalves

Palm-switch Red	200-895	26-205
Pushbutton Red	200-975	26-206
2 - position selector	200-990	26-207
3 - position selector	200-870	26-208



I . A . C . Komponenter AB

International Automation Components

P.O Box 60, S-566 22 Habo Phone: +46 (0)36 477 00 Fax: +46 (0)36 477 15

E-mail: habo@iackomp.se www.iackomp.se

Pneumatic Valves

Pneumatic valves and accessories

• Camozzi • Also available in other dimensions and models.

Size	Type.No.	Part.No.
Pedal		
M5 - 3/2	235-925	26-216
1/4" - 5/2	354N-925	26-217
Manually Operated Valves		
1/8" - 3/2	338-900	26-221
1/8" - 3/2	338-975	26-223
1/8" - 3/2	338-990	26-224
1/8" - 5/2	358-900	26-231
1/8" - 5/2	358-905	26-232
1/8" - 5/2	358-975	26-233
1/8" - 5/3	368-900	26-235
1/8" - 5/3	368-905	26-236
1/4" - 5/2	454-900	26-245
1/4" - 5/2	454-905	26-246
Manually Operated Valves		
1/8" - 3/2	VMS-118	26-301
1/4" - 3/2	VMS-114	26-302
1/2" - 3/2	VMS-112	26-304
Circuit Selector		
1/8"	SCS-668-06	26-306
Flow Control Valves		
M5 x 4 mm	GSCU-814	26-311
1/8" x 6 mm	GSCU-803	26-312
1/8" x 8 mm	GSCU-804	26-313
1/4" x 10 mm	GSCU-806	26-315
Flow Control Valves with silencer		
1/8"	RSW	26-321
1/4"	RSW	26-322
M5	SCO 2905	26-325
1/8"	SCO 2905	26-326
1/4"	SCO 2905	26-327
Silencer brass		
M5		22-120
1/8"		22-121
1/4"		22-122
3/8"		22-123
1/2"		22-124
Silencer brass		
1/8"		22-126
1/4"		22-127
3/8"		22-128
1/2"		22-129
Silencer for female thread brass		
1/8"		22-131
1/4"		22-132



I . A . C . Komponenter AB
International Automation Components

P.O Box 60, S-566 22 Habo Phone: +46 (0)36 477 00 Fax: +46 (0)36 477 15
E-mail: habo@iackomp.se www.iackomp.se

Pneumatic Valves

Pneumatic valves and accessories

• Camozzi • Also available in other dimensions and models.



Size	Type.No.	Part.No.
Check Valves		
1/8"	VNR-210	26-331
1/4"	VNR-843	26-332



Quick Exhaust Valves		
1/8"	VSC 588	26-341
1/4"	VSC 544	26-342
1/2"	VSC 522	26-343



Flow Control Valves		
1/8" female	2830	26-351
1/4" female	2830	26-352
3/8" female	2830	26-353
1/2" female	2830	26-354



I . A . C . Komponenter AB

International Automation Components

P.O. Box 60, S-566 22 Habo Phone: +46 (0)36 477 00 Fax: +46 (0)36 477 15

E-mail: habo@iackomp.se www.iackomp.se

Switchgear and Gas bottle cabinets

- Schramm • Made of Fiberglass Reinforced Polyester with external parts in stainless steel • Designed for aggressive environments • Standard colour grey (RAL 7035) • Available in "Ex"-model and other colours • Gas bottle cabinets available in sheet steel

Schramm No.	Size HxWxD	Part.No.		
Switchgear Cabinets Series KS				
		Cabinet	M.plate	Weight
Insulated cabinets	KS 600 -1000 -300 -20	51-154	51-3011	22 kg
	KS 600 -1000 -450 -20	51-155	51-3011	25 kg
10 - Single door front	KS 700 - 500 -300 -10	51-157	51-3131	15 kg
20 - Double door front	KS 700 - 500 -450 -10	51-158	51-3131	17 kg
Standard Features	KS 750 - 750 -300 -10	51-161	51-3151	20 kg
	KS 750 - 750 -400 -10	51-162	51-3151	22 kg
- Colour: RAL7035 grey tone	KS 800 -1000 -300 -20	51-165	51-3031	25 kg
	KS 800 -1000 -500 -20	51-166	51-3031	29 kg
- 3-point latch-bolt with pivoted lever handle and profile cylinder	KS 1000 - 600 -300 -10	51-171	51-3011	21 kg
	KS 1000 - 600 -450 -10	51-172	51-3011	24 kg
- Posterior wall fitted with screw sockets M 10 made of stainless steel	KS 1000 - 800 -300 -10	51-173	51-3031	24 kg
	KS 1000 - 800 -500 -10	51-174	51-3031	28 kg
- Protection factor IP 65	KS 1000 -1000 -300 -10	51-176	51-3051	28 kg
- Cabinets can be delivered with mounting plates or mounting assemblies	KS 1000 -1000 -500 -10	51-177	51-3051	32 kg
	KS 1000 -1000 -300 -20	51-178	51-3051	29 kg
	KS 1000 -1000 -500 -20	51-179	51-3051	33 kg
	KS 1100 -1100 -500 -10	*	*	41 kg
	KS 1100 -1100 -600 -10	*	*	48 kg
	KS 2060 - 900 -500 -10	*	*	60 kg
	KS 2060 - 900 -600 -10	*	*	70 kg

-P - Uninsulated
-PS - Insulated

Most cabinet models and sizes are available in painted sheet steel or stainless sheet steel.

Uninsulated cabinet

Gas bottle cabinets model FS-PS	Weight	Number of bottles
FG-P 450 - 660 -310	9 kg	1 pcs
FS-PS 2065 -1000 -500-10	69 kg	3 pcs
FS-PS 2065 -1200 -500-10	89 kg	4 pcs
FS-PS 2065 -1500 -500-20	100 kg	5 pcs
FS-PS 2065 -2000 -500-20	123 kg	7 pcs

Skåp typ FS-SP sheet steel	Weight	Number of bottles
FS-ST 2050 - 640 -400-10	81 kg	2 pcs
FS-ST 2050 - 940 -400-20	98 kg	3 pcs
FS-ST 2050 -1240 -400-20	132 kg	4 pcs
FS-ST 2050 -1540 -400-20	164 kg	5 pcs
FS-ST 2050 -1840 -400-30	193 kg	6 pcs
FS-ST 2050 -2140 -400-30	217 kg	7 pcs
FS-ST 2050 -2440 -400-40	250 kg	8 pcs



-KS

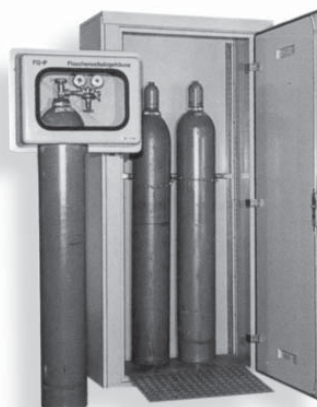

-FG-P



-FS-PS

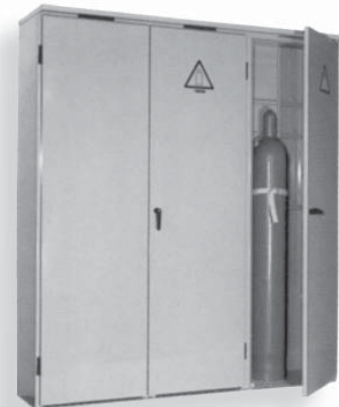

-FS-ST



I . A . C . Komponenter AB

International Automation Components

P.O Box 60, S-566 22 Habo Phone: +46 (0)36 477 00 Fax: +46 (0)36 477 15

E-mail: habo@iackomp.se www.iackomp.se

Switchgear cabinets

- Schramm • Switchgear cabinets are made of Fiberglass Reinforced Polyester with external parts in stainless steel • Designed for aggressive environments • Standard colour grey (RAL 7035) • Available in "Ex"-model and other colours

Schramm No. Size HxWxD

Insulated cabinet

E01:Height - 1190 mm

E02:Height - 2140 mm

* Available with different door alternatives:

10 - Single door front

11 - Single door front and back

20 - Double door front

21 - Double door front and back

10+10 - 2 Single doors front

11+11 - 2 Single doors front and back

Switchgear cabinets E Floor

Weight

E 01 -1000 - 500 -*	61 kg
E 01 -1000 - 600 -*	67 kg
E 01 -1000 -1000 -*	90 kg
E 01 -1200 - 500 -*	70 kg
E 01 -1200 - 600 -*	77 kg
E 01 -1200 -1000 -*	105 kg
E 01 -1500 - 500 -*	90 kg
E 01 -1500 - 600 -*	99 kg
E 01 -1500 -1000 -*	134 kg
E 01 -2000 - 500 -*	106 kg
E 01 -2000 - 600 -*	115 kg
E 01 -2000 -1000 -*	183 kg
E 02 -1000 - 500 -*	90 kg
E 02 -1000 - 600 -*	98 kg
E 02 -1000 -1000 -*	128 kg
E 02 -1200 - 500 -*	103 kg
E 02 -1200 - 600 -*	111 kg
E 02 -1200 -1000 -*	148 kg
E 02 -1500 - 500 -*	122 kg
E 02 -1500 - 600 -*	132 kg
E 02 -1500 -1000 -*	180 kg
E 02 -2000 - 500 -*	154 kg
E 02 -2000 - 600 -*	165 kg
E 02 -2000 -1000 -*	240 kg

Standard features

- Colour: RAL 7035 grey tone
- 3-point latch-bolt with pivoted lever handle and profile cylinder
- Posterior wall fitted with screw sockets M 10 made of stainless steel
- Roof overhang 50 mm all around
- Cabinets can be delivered with mounting plates or mounting assemblies

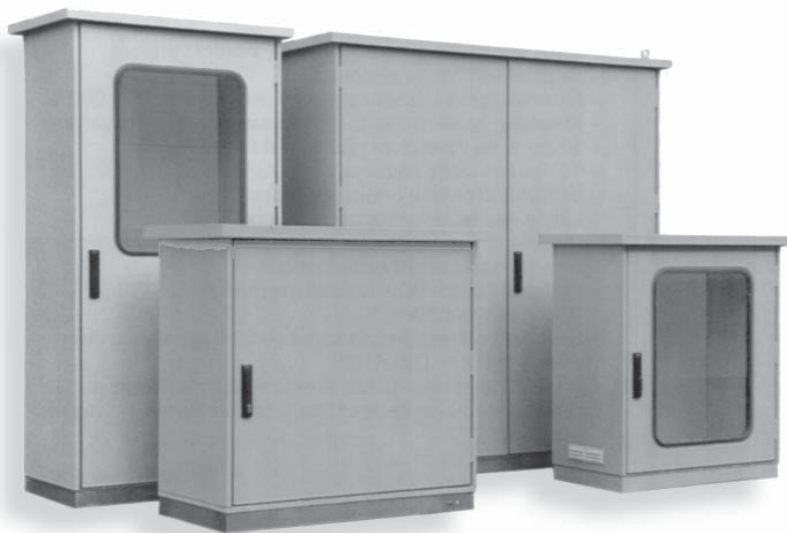

-E01, E02



I . A . C . Komponenter AB

International Automation Components

P.O Box 60, S-566 22 Habo Phone: +46 (0)36 477 00 Fax: +46 (0)36 477 15

E-mail: habo@iackomp.se www.iackomp.se

Stainless Cabinets

Switchgear cabinets

- Manufacture: IAC • Stainless Steel 304
- Wall thickness 1,5mm



Size HxWxD	Part.No.	Weight
Cabinet Type RF IP55		
RF 300x250x150, m.plate 251x201	52-052	6,4 kg
RF 300x250x200, m.plate 251x201	52-053	7,0 kg
RF 300x300x150, m.plate 251x251	52-054	7,0 kg
RF 350x250x150, m.plate 301x201	52-055	7,0 kg
RF 350x250x200, m.plate 301x201	52-056	8,0 kg
RF 400x300x150, m.plate 351x251	52-057	9,6 kg
RF 400x300x200, m.plate 351x251	52-058	9,9 kg
RF 400x400x200, m.plate 351x351	52-059	10,5 kg
RF 500x300x200, m.plate 451x251	52-061	11,4 kg
RF 500x350x200, m.plate 451x301	52-063	12,8 kg
RF 500x400x250, m.plate 451x351	52-065	15,9 kg
RF 600x400x200, m.plate 551x351	52-067	17,0 kg
RF 600x400x250, m.plate 551x351	52-068	19,1 kg
RF 700x500x250, m.plate 651x451	52-072	24,5 kg
RF 800x500x250, m.plate 751x451	52-074	28,0 kg
RF 800x600x250, m.plate 751x551	52-076	30,8 kg
RF 800x600x300, m.plate 751x551	52-077	32,5 kg
RF 900x600x250, m.plate 851x551	52-079	34,7 kg
RF 1000x800x250, m.plate 951x751	52-084	46,0 kg
RF 1200x800x250, m.plate 1151x751	52-087	55,4 kg

Accessories

Lock with key	52-093
Wallbracket 4pcs SS 304	52-095



I . A . C . Komponenter AB

International Automation Components

P.O Box 60, S-566 22 Habo Phone: +46 (0)36 477 00 Fax: +46 (0)36 477 15

E-mail: habo@iackomp.se www.iackomp.se

Accessories

• Schramm, if nothing else is noted



Cabinet accessories	Part.No.
Heaters Std. incl. temp.-regulator	
SKH EI.heater 250W/230V	51-401
SKH EI.heater 500W/230V	51-402
H1 Steam/Water	*
H2 Steam/Water	*
Heater "Ex" incl. temp.-regulator TS10 +20°C	
FSHK T3 200W/230V	51-421
FSHK T4 200W/230V	51-422
FSHK T3 300W/230V	51-423
FSHK T4 300W/230V	51-424
FSHK T3 500W/230V	51-425
Temperature-Regulator "EX"	
TS 10 +10°C	51-415
TS 10 +20°C	51-414
TS 10 +30°C	51-416
ETR 5/80 +5°C – +80°C	51-4131
Heatingplate "EX"	
EHP 200 T4 200W/230V	51-435

Accessories

• Schramm, if nothing else is noted



Cabinet accessories	Part.No.		
Z-profile "IAC" stainless	Schramm	Sarel	Rittal
L= 290 To 1423	—	—	57-060
L= 340 To 9016, 1432	—	57-061	57-061
L= 390 To 1434	—	—	57-062
L= 430 To PV 530, P4.1xx	57-067	—	—
L= 550 To P4.2xx	57-070	—	—
L= 590 To PV 600, 9025, 1446	57-064	57-064	57-064
L= 670 To PV 700, 750, P4.3xx	57-068	—	—
L= 780 To PV 800, 1468	57-066	—	57-066
L= 990 To PV 1000, 1480	57-069	—	57-069

Accessories

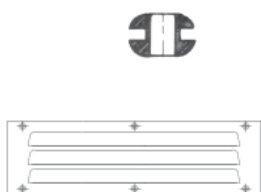

Rubber wall entrances 6 mm	51-495
Rubber wall entrances 12 mm	51-496
Vent. cover outside type 1	51-491
Vent. cover inside type 2	51-492
Insulation plate 500 x 1000 x 20 mm	57-200
Latch handle with key 0500	51-400
Latch handle without key 0502	51-399
T-handle lock with key 0506	51-396
T-handle without key 0505	51-395
Catch lock with 3 mm pivot 0509	51-3943
Catch lock with key 0510	51-394
Panik lock with cylinder 0513	51-3961
Swivel handle without cylinder 0523	51-3962
Cylinderlock for swivel handle 0523	51-3965
Clasp locking complete for P4	51-397
Hinges complete for P4	51-398

* - by order

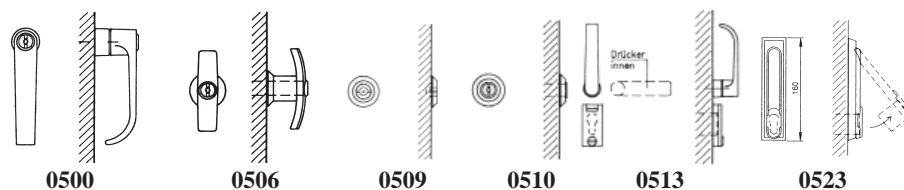

Module Cabinets

- Schramm • Fiberglass reinforced polyester with a core of PU-foam
- The Cabinets are also available in painted sheet steel or stainless sheet steel and in other models

ESK Series

SCHRAMM element cabinets, developed from a decade of building experience, can be constructed in many ways, when predetermined width, depth and height measurements are adhered to. Many fundamental variations can be realized and individual customer requirements can be accommodated. As the floor, walls and roof are built in one piece, the possibility exists to assemble the cabinet on site and to enlarge or to interchange single elements among one another.



ESK-20

As a special advantage, model ESK-80 with 80 mm wall thickness and insulated floor base ensures an optimal insulation rate of $k=0,35 \text{ W/m}^2\text{K}$.

Doors are outfitted and mounted with sturdy stainless steel hinges and angled rims which are painted in the same colour tone as the cabinet. The door can be opened 180°. They are sealed with high quality lip-profile rubber so that the protection factor IP 65 for single doors and IP 54 for double doors is guaranteed.

Stainless steel screw sockets M 10 are furnished in all wall elements to allow for various types of inner installations and also high weight capacities.

The series ESK construction is absolutely dimensionally stable and self supporting without any additional statical support system. All element cabinets are produced in a double skinned sandwich construction of fiberglass reinforced polyester with a core of PU-foam and are hermetically sealed. They are not only thermally insulated but also resistant to corrosion and the caustic effects of sea water. A stable, stainless steel floor base, designed for high load capacities, carries the cabinet. A variety of floor models are available on request.



ESK-80



I . A . C . Komponenter AB

International Automation Components

P.O Box 60, S-566 22 Habo Phone: +46 (0)36 477 00 Fax: +46 (0)36 477 15

E-mail: habo@iackomp.se www.iackomp.se

Module Cabinets

- Schramm • Fiberglass reinforced polyester with a core of PU-foam
- The Cabinets are also available in painted sheet steel or stainless sheet steel and in other models

ESK Series

Roof Elements

- Double skinned sandwich construction (PU-foam)
- Walk able roof, high mechanical stability
- Width lay out for ratchet measurements 500 and 1000 mm
- Span width up to 4100 mm

Floor

- Floor constructions available in various designs.
The separate variations are suite for factory requirements
- Frame in stainless U-profile 80 mm ESK-20 (ESK-80 100 mm)
 - Without floor
 - Floor with aluminium checker-plate insulated with PU-foam
 - Floor with aluminium checker-plate insulated with stone wool and an additional aluminium plate

Cabinet Height

<i>Model</i>	<i>Wall element height</i>	<i>Cabinet height without/with floor</i>
ESK-20	2020 mm	2140/2145 mm
ESK-20	2420 mm	2540/2545 mm
ESK-20	2820 mm	2940/2945 mm
ESK-80	2420 mm	2600/2605 mm
ESK-80	2820 mm	3000/3005 mm

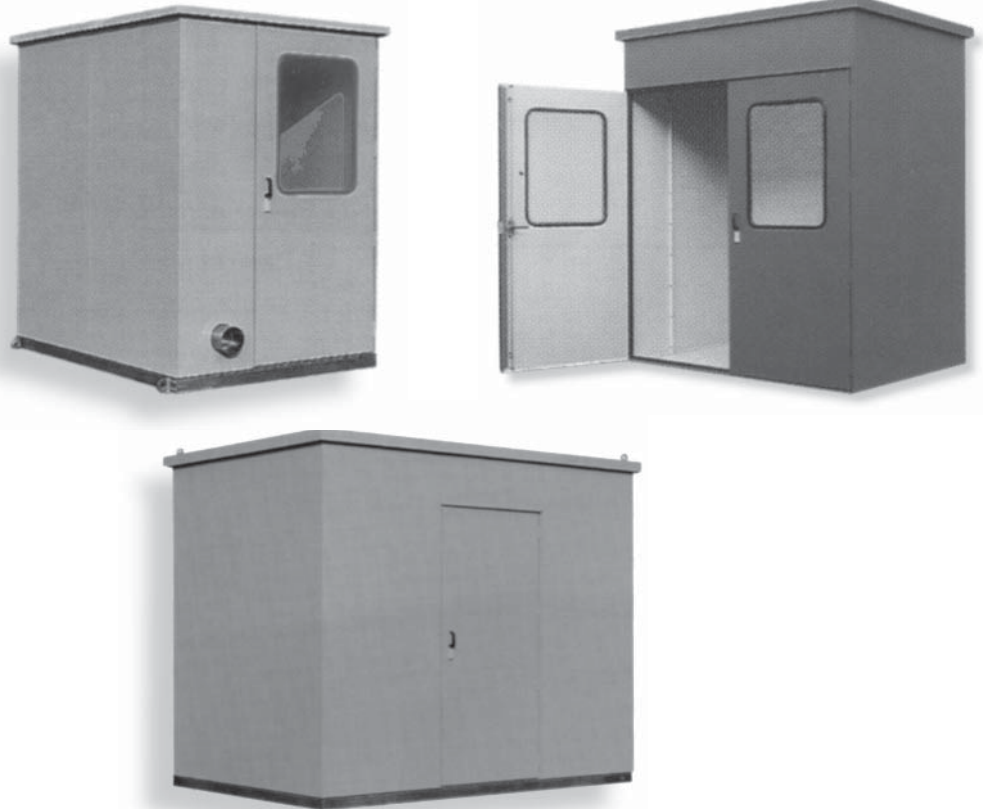

I . A . C . Komponenter AB

International Automation Components

P.O Box 60, S-566 22 Habo Phone: +46 (0)36 477 00 Fax: +46 (0)36 477 15

E-mail: habo@iackomp.se www.iackomp.se

Module Cabinets

- Schramm • Fiberglass reinforced polyester with a core of PU-foam
- The Cabinets are also available in painted sheet steel or stainless sheet steel and in other models

Measurements

A- Middle Element ESK-20

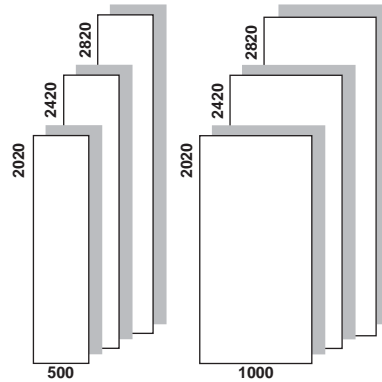

Width: 500 mm, 1000 mm

Height: 2020 mm, 2420 mm, 2820 mm

Size and height measurements of the cabinet is manufactured on your request.

B - Corner Element ESK-20

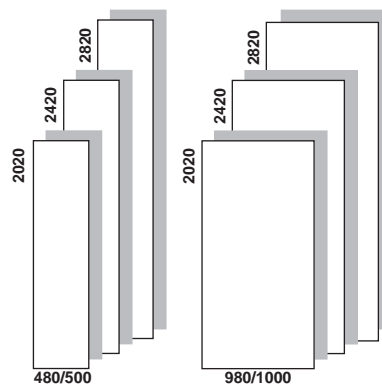

Width: 480/500 mm, 980/1000 mm

Height: 2020 mm, 2420 mm, 2820 mm

The corner element is combined with the middle element for every corner.

C - Door Element ESK-20

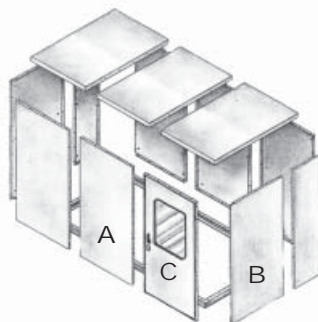
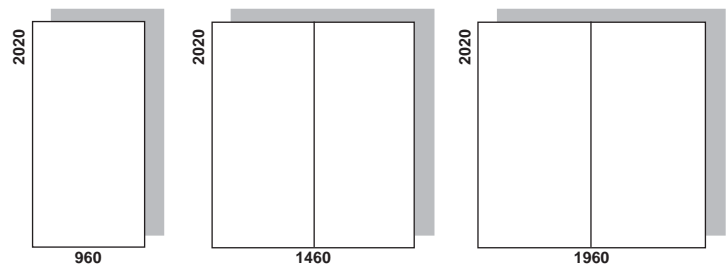

Outer measurements:

Width:	960 mm	1460 mm	1960 mm
Height:	2020 mm	2020 mm	2020 mm

Inner measurements:

Width:	880 mm	1380 mm	1880 mm
Height:	1940 mm	1940 mm	1940 mm

Module Cabinets

- Schramm • Fiberglass reinforced polyester with a core of PU-foam
- The Cabinets are also available in painted sheet steel or stainless sheet steel and in other models

Features

Standard Features

- Colour: RAL 7035 grey tone
- All wall elements are fitted with screw sockets M 10 made of stainless steel
- Roof overhang 50 mm all around

Model ESK-20:

- Wall and door elements 20 mm thick
- Roof elements 40 mm thick
- Insulation coefficient $k=1,2 \text{ W/m}^2 \text{ K}$
- 3-pont latch bolt with latch handle, panic function, lockable profile cylinder (lock no. 0501)
- Open floor, stainless steel floor frame 50 x 80 x 80 x 2,5

Model ESK-80:

- Wall, door and roof elements 80 mm thick
- Insulation coefficient $k=0,35 \text{ W/m}^2 \text{ K}$
- Tumble bolt lock with a latch key, panic function, possibility of profile cylinder
- Aluminium checkered plate floor, stainless steel floor frame 100 x 100 x 100 x 3, PU-foam insulation

Mounting plate and assemblies

- Sheet steel 2,5 mm thick
- For wall element 480/ 500 mm: W= 400, H= 1930 mm
- For wall element 980/1000 mm: W= 900, H= 1930 mm
- Other sizes and materials on request
- Mounting Assemblies C-profile

Extra Features

- Other RAL-colour tones
- Reduced electrical surface resistance in accordance with DIN EN 50014 ($< 10^9 \Omega$)
- Profile rubber sealed observation windows of laminated safety glass or acrylic glass in doors and wall elements
- Other lock variations
- Door stop with pressurized spring
- Steam and hot water heating
- Electrical heating in normal and Ex-proof versions
- Cabinet ventilation system
- Mounting plates
- Mounting assemblies C-profile
- Lighting, air ducts, air conditioning and other equipment can be installed if desired
- Lifting eye bolts for normal and heavy weight capacities
- Transport- or mounting joints at base frame
- Other floor designs
- Wider roof designs
- Elements correspond to fire surface resistance class F 30 and B 1 - DIN 4102
- Various cabinet heights and design variations upon inquiry
- Sluiceways and porches upon inquiry
- Integrated gas bottle cabinets upon inquiry











I . A . C . Komponenter AB

International Automation Components

P.O Box 60, S-566 22 Habo Phone: +46 (0)36 477 00 Fax: +46 (0)36 477 15
E-mail: habo@iackomp.se www.iackomp.se

Ball valves

- Ball valves nickelplated brass and stainless steel SS 316 - 2343.
- Male thread KR (BSPT) - European taper
- Female thread R (BSPP) - European parallel
- NPT - American taper thread

Size	Type.No.	Part.No.
	Ball valve PN10 nickelplated brass	BSP
1/4" male x female		61-001
3/8" male x female		61-002
1/2" male x female		61-003
	Ball valve PN10 nickelplated brass	BSP
1/4" female		61-006
3/8" female		61-007
1/2" female		61-008
	Ball valve Mini PN10 nickelplated brass	BSP
1/8" male x female.		61-020
1/4" male x female		61-021
	Ball valve Mini PN56 stainless SS 316	BSPP
1/4" female		61-1502
	Ball valve PN63 fullbore stainless SS 316	BSPP
1/4" female		61-1501
3/8" female		61-1511
1/2" female		61-1521
3/4" female		61-1531
1" female		61-1541
1 1/4" female		61-1551
1 1/2" female		61-1561
	Kulventil PN63 with venting fullbore SS 316	BSPP
1/4" female		61-170
3/8" female		61-171
1/2" female		61-172
	Ball valve PN200 Safelok stainless SS 316	NPT
1/4" female	BV2N-SS	61-655
3/8" female	BV3N-SS	61-656
1/2" female	BV4N-SS	61-657
	Kulventil 3-vägs PN65 syrafast	BSPP
1/2" female "L"-port		61-162
1/4" female "T"-port		61-165
1/2" female "T"-port		61-167

Pressure-temperature rating for Ball valve PN63

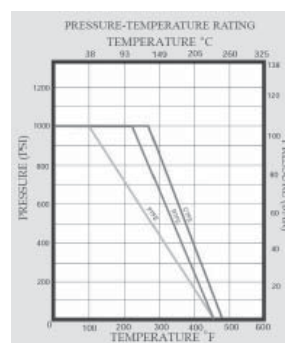

I . A . C . Komponenter AB
International Automation Components

P.O Box 60, S-566 22 Habo Phone: +46 (0)36 477 00 Fax: +46 (0)36 477 15
E-mail: habo@iackomp.se www.iackomp.se



Ball valve Alco

- Alco • Stainless steel SS 316 - 2343 • Industrial valves with high quality
- Most models are available in sizes up to 2 1/2" and in different materials
- All valves are available with NPT-, BSPP- or BSPT-pipe threads



Size	Type.No.	Part.No.	
------	----------	----------	--

Ball valve Mini PN50 "A"-series		NPT	BSPP
---------------------------------	--	-----	------

1/4" female	MA2xS	61-301	61-300
1/4" male x female	MA2xS-LM	61-304	61-303

Ball valve Barstock PN50 "A"-series		NPT	BSPP
-------------------------------------	--	-----	------

1/4" female	A2xS	*	*
3/8" female	A3xS-LM	61-312	61-311
1/2" female	A4xS-LM	61-317	61-316
3/4" female	A6xS	*	*
1" female	A8xS	*	*

Ball valve Barstock PN130 "A"-series			
--------------------------------------	--	--	--

1/4" female	RA2xS	*	
3/8" female	RA3xS-LM	*	
1/2" female	RA4xS-LM	*	
3/4" female	RA6xS	*	
1" female	RA8xS	*	

Ball valve Barstock PN64 "B"-series			
-------------------------------------	--	--	--

1/4" female	B2xS	*	
3/8" female	B3xS	*	
1/2" female	B4xS	*	
3/4" female	B6xS	*	
1" female	B8xS	*	

Ball valve Barstock PN130 "B"-series			
--------------------------------------	--	--	--

1/4" female	RB2xS	*	
3/8" female	RB3xS	*	
1/2" female	RB4xS	*	
3/4" female	RB6xS	*	
1" female	RB8xS	*	

Ball valve Barstock PN200 "B"-series			
--------------------------------------	--	--	--

1/4" female	HB2xS	*	
3/8" female	HB3xS	*	
1/2" female	HB4xS	*	
3/4" female	HB6xS	*	
1" female	HB8xS	*	

Ball valve Barstock PN400 "B"-series			
--------------------------------------	--	--	--

1/4" female	PB2xS	*	
3/8" female	PB3xS	*	
1/2" female	PB4xS	*	
3/4" female	PB6xS	*	
1" female	PB8xS	*	

Ball valve Panel mount PN64			
-----------------------------	--	--	--

1/4" female	SB2xS	*	
3/8" female	SB3xS	*	
1/2" female	SB4xS	*	
3/4" female	SB6xS	*	
1" female	SB8xS	*	

* - by order



I . A . C . Komponenter AB

International Automation Components

P.O Box 60, S-566 22 Habo Phone: +46 (0)36 477 00 Fax: +46 (0)36 477 15
E-mail: habo@iackomp.se www.iackomp.se



Ball valve Alco

- Alco • Stainless steel SS 316 - 2343 • Industrial valves with high quality
- Most models are available in sizes up to 2 1/2" and in different materials
- All valves are available with NPT-, BSPP- or BSPT-pipe threads



Size	Type.No.	Part.No.
------	----------	----------

Ball valve Panel mount PN 130

1/4" female	RSB2xS	*
3/8" female	RSB3xS	*
1/2" female	RSB4xS	*
3/4" female	RSB6xS	*
1" female	RSB8xS	*

Ball valve Panel mount PN 200

1/4" female	HSB2xS	*
3/8" female	HSB3xS	*
1/2" female	HSB4xS	*
3/4" female	HSB6xS	*
1" female	HSB8xS	*

Ball valve Panel mount PN 400

1/4" female	PSB2xS	*
3/8" female	PSB3xS	*
1/2" female	PSB4xS	*
3/4" female	PSB6xS	*
1" female	PSB8xS	*



Ball valve Panel mount PN 64

1/4" female	SN2xS	*
3/8" female	SN3xS	*
1/2" female	SN4xS	*

Ball valve Panel mount PN 200

1/4" female	HSN2xS	*
3/8" female	HSN3xS	*
1/2" female	HSN4xS	*

Ball valve Panel mount PN 400

1/4" female	PSN2xS	*
3/8" female	PSN3xS	*
1/2" female	PSN4xS	*

Ball valve Panel mount PN 670

1/4" female	USN2xS	*
3/8" female	USN3xS	*
1/2" female	USN4xS	*



Ball valve Compression ended PN64 "B"-series

6 mm OD	B2xCS	*
8 mm OD	B3xCS	*
10 mm OD	B4xCS	*
12 mm OD	B6xCS	*

Ball valve Compression ended PN130 "B"-series

6 mm OD	RB2xCS	*
8 mm OD	RB3xCS	*
10 mm OD	RB4xCS	*
12 mm OD	RB6xCS	*

* - by order



I . A . C . Komponenter AB

International Automation Components

P.O Box 60, S-566 22 Habo Phone: +46 (0)36 477 00 Fax: +46 (0)36 477 15
E-mail: habo@iackomp.se www.iackomp.se



Ball valve Alco

- Alco • Stainless steel SS 316 - 2343 • Industrial valves with high quality
- Most models are available in sizes up to 2 1/2" and in different materials
- All valves are available with NPT-, BSPP- or BSPT-pipe threads



Size	Type.No.	Part.No.
Ball valve Compression ended PN200 "B"-series		
6 mm OD	HB2xCS	*
8 mm OD	HB3xCS	*
10 mm OD	HB4xCS	*
12 mm OD	HB6xCS	*

Ball valve Compression ended PN400 "B"-series		
6 mm OD	PB2xCS	*
8 mm OD	PB3xCS	*
10 mm OD	PB4xCS	*
12 mm OD	PB6xCS	*



Ball valve 3-way "L"-port PN64		
1/4" female	SB2xS-3L	*
3/8" female	SB3xS-3L	*
1/2" female	SB4xS-3L	*
3/4" female	SB6xS-3L	*
1" female	SB8xS-3L	*



Ball valve 3-way "B"-port PN64		
1/4" female	SB2xS-3B	*
3/8" female	SB3xS-3B	*
1/2" female	SB4xS-3B	*
3/4" female	SB6xS-3B	*
1" female	SB8xS-3B	*

Ball valve 3-way "L"-port PN200		
1/4" female	HSB2xS-3L	*
3/8" female	HSB3xS-3L	*
1/2" female	HSB4xS-3L	*
3/4" female	HSB6xS-3L	*
1" female	HSB8xS-3L	*

Ball valve 3-way "B"-port PN200		
1/4" female	HSB2xS-3B	*
3/8" female	HSB3xS-3B	*
1/2" female	HSB4xS-3B	*
3/4" female	HSB6xS-3B	*
1" female	HSB8xS-3B	*

Ball valve 3-way "L"-port PN400		
1/4" female	PSB2xS-3L	*
3/8" female	PSB3xS-3L	*
1/2" female	PSB4xS-3L	*
3/4" female	PSB6xS-3L	*
1" female	PSB8xS-3L	*

Ball valve 3-way "B"-port PN400		
1/4" female	PSB2xS-3B	*
3/8" female	PSB3xS-3B	*
1/2" female	PSB4xS-3B	*
3/4" female	PSB6xS-3B	*
1" female	PSB8xS-3B	*

* - by order



I . A . C . Komponenter AB

International Automation Components

P.O Box 60, S-566 22 Habo Phone: +46 (0)36 477 00 Fax: +46 (0)36 477 15
E-mail: habo@iackomp.se www.iackomp.se



Ball valve Alco

- Alco • Stainless steel SS 316 - 2343 • Industrial valves with high quality
- Most models are available in sizes up to 2 1/2" and in different materials
- All valves are available with NPT-, BSPP- or BSPT-pipe threads



Size	Type.No.	Part.No.
------	----------	----------

Ball valve 4-way PN64

1/4" female	SB2xS-x4	*
3/8" female	SB3xS-x4	*
1/2" female	SB4xS-x4	*
3/4" female	SB6xS-x4	*
1" female	SB8xS-x4	*

Ball valve 4-way PN200

1/4" female	HSB2xS-x4	*
3/8" female	HSB3xS-x4	*
1/2" female	HSB4xS-x4	*
3/4" female	HSB6xS-x4	*
1" female	HSB8xS-x4	*

Ball valve 4-way PN400

1/4" female	PSB2xS-x4	*
3/8" female	PSB3xS-x4	*
1/2" female	PSB4xS-x4	*
3/4" female	PSB6xS-x4	*
1" female	PSB8xS-x4	*



Multiport gauge valves PN64

1/4" female	32FxS	*
1/4" female x male	32MxS	*
1/2" female	34FxS	*
1/2" female x male	34MxS	*

Multiport gauge valves PN200

1/4" female	H32FxS	*
1/4" female x male	H32MxS	*
1/2" female	H34FxS	*
1/2" female x male	H34MxS	*

Multiport gauge valves PN400

1/4" female	P32FxS	*
1/4" female x male	P32MxS	*
1/2" female	P34FxS	*
1/2" female x male	P34MxS	*



Ball valve Sandwich style PN100 "S"-series BSPP

1/4" female	S2xS	*
3/8" female	S3xS	61-372
1/2" female	S4xS	61-373
3/4" female	S6xS	*
1" female	S8xS	*

Ball valve Sandwich style PN200 "S"-series

1/4" female	HS2xS	*
3/8" female	HS3xS	*
1/2" female	HS4xS	*
3/4" female	HS6xS	*
1" female	HS8xS	*

* - by order



I . A . C . Komponenter AB

International Automation Components

P.O Box 60, S-566 22 Habo Phone: +46 (0)36 477 00 Fax: +46 (0)36 477 15
E-mail: habo@iackomp.se www.iackomp.se

Needle Valves

Needle valves

• Safelock • Stainless steel SS 316 - 2343 • Also available with BSPP- and BSPT-pipe thread.



Size	Type.No.	Part.No.
Needle valve PN 400		NPT
1/4" female	IV2N-SS	61-602
3/8" female	IV3N-SS	61-603
1/2" female	IV4N-SS	61-604
1/4" female x male	IV2NMF-SS	61-607
3/8" female x male	IV3NMF-SS	61-608
1/2" female x male	IV4NMF-SS	61-609
Needle valve PN 400 with compression end		
6 mm OD	IV6MC2S	61-616
12 mm OD	IV12MC2S	61-619
Needle valve PN 400 welded (Socket Weld)		
12 mm SW	IV12mSWS-6-GP-ST	61-624
Needle valve PN 400 with welding connection		
12 mm SW		61-634
12 mm SW x 1/2" NPT		61-638
Gauge needle valve PN 400		NPT
1/2" female x male	IVMG4N-SS+VBP2N	61-648
Gauge adaptor swivel, 2-pieces		
1/2" female BSPP x 1/2" male NPT		61-198
Gauge adaptor swivel, 3-pieces		
1/2" female BSPP x 1/2" male NPT		61-6492
Gauge nipple		
1/2" female BSPP x 3/8" male BSPP		61-183
1/2" male BSPP x 1/2" female NPT		61-195
1/2" male BSPP x 1/2" male NPT		61-192
Gauge Nut		
3/8" female BSPP right/left threaded		61-188
1/2" female BSPP right/left threaded		61-189



I . A . C . Komponenter AB

International Automation Components

P.O Box 60, S-566 22 Habo Phone: +46 (0)36 477 00 Fax: +46 (0)36 477 15

E-mail: habo@iackomp.se www.iackomp.se

Needle Valves

Needle valves

• Safelock • Stainless steel SS 316 - 2343 • Also available with BSPP- and BSPT-pipe thread.



Size	Type.No.	Part.No.
Check valve PN 400		NPT
1/4" male	VP2N-SS	61-640
1/2" male	VP4N-SS	61-642
Check valve PN 400		NPT
1/4"	CV2N-SS	61-671
1/2"	CV4N-SS	61-673
6 mm OD	CV6mC2-SS	61-675
12 mm OD	CV12mC2-SS	61-678
Gauge needle valve PN 400 with flange		
3/8"		61-256
1/2"		61-257



I . A . C . Komponenter AB

International Automation Components

P.O Box 60, S-566 22 Habo Phone: +46 (0)36 477 00 Fax: +46 (0)36 477 15

E-mail: habo@iackomp.se www.iackomp.se

Butterfly Valves

Butterfly valves

- Huluhammar • Damper made in stainless steel SS 316 - 2343, Valve house in silumine and valve gasket in neoprene (std.), hypalon, viton, nitril, butyl or steel • High quality valve made in Sweden • We can special produce, on your request

Flange diameter	Type.No.
-----------------	----------

Butterfly valve hand regulated (-hm)

Inside Ø	Outside Ø	Flange thickness	No. holes x thread	
100	160	50	4 x M8	G-100-hm
150	210	50	4 x M8	G-150-hm
200	260	50	6 x M8	G-200-hm
250	340	60	6 x M10	G-250-hm
300	390	60	8 x M10	G-300-hm
400	530	100	16 x M12	G-400-hm
500	640	100	20 x M12	G-500-hm

Butterfly valve with pneumatic cylinder (-pc)

Inside Ø	Outside Ø	Height over flange	Stick out fr. flange	
100	160	75	285	G-100-pc
150	210	95	300	G-150-pc
200	260	95	375	G-200-pc
250	340	140	355	G-250-pc
300	390	115	390	G-300-pc
400	530	155	625	G-400-pc
500	640	150	575	G-500-pc



-hm

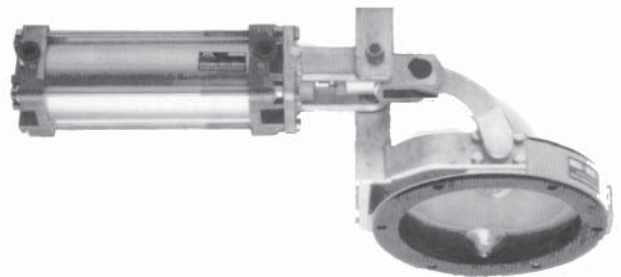

-pc



I . A . C . Komponenter AB

International Automation Components

P.O Box 60, S-566 22 Habo Phone: +46 (0)36 477 00 Fax: +46 (0)36 477 15

E-mail: habo@iackomp.se www.iackomp.se

Butterfly Valves

Butterfly valves

- Huluhammar • Damper made in stainless steel SS 316 - 2343, Valve house in silumine and valve gasket in neoprene (std.), hypalon, viton, nitril, butyl or steel • High quality valve made in Sweden • We can special produce, on your request

Flange diameter			Type.No.
Butterfly pneumatic valve double working (-pvd)			
<i>Inside Ø</i>	<i>Outside Ø</i>	<i>Height over flange</i>	
100	160	180	G-100-pvd
150	210	180	G-150-pvd
200	260	180	G-200-pvd
250	340	245	G-250-pvd
300	390	245	G-300-pvd
400	530	250	G-400-pvd
500	640	245	G-500-pvd
Butterfly pneumatic valve single working (-pve)			
<i>Inside Ø</i>	<i>Outside Ø</i>	<i>Height over flange</i>	
100	160	180	G-100-pve
150	210	180	G-150-pve
200	260	180	G-200-pve
250	340	245	G-250-pve
300	390	245	G-300-pve
Butterfly valve with electrical gear motor (-sv)			
<i>Inside Ø</i>	<i>Outside Ø</i>	<i>Height over flange</i>	
100	160	440	G-100-sv
150	210	440	G-150-sv
200	260	440	G-200-sv
250	340	440	G-250-sv
300	390	440	G-300-sv
400	530	660	G-400-sv
500	640	660	G-500-sv



-pvd, pve



-sv



I . A . C . Komponenter AB

International Automation Components

P.O Box 60, S-566 22 Habo Phone: +46 (0)36 477 00 Fax: +46 (0)36 477 15

E-mail: habo@iackomp.se www.iackomp.se

Valve Manifolds

Valve manifolds

• Safelok • Stainless steel SS 316 - 2343 • Also available with BSPP- and BSPT-pipe thread.



Size	Type.No.	Part.No.
Two valve manifold PN 400		
1/2" female NPT	IV2R4N-A-SS	65-257
1/2" female NPT x female BSPP	IV2R4NP-A-SS	65-259
Two valve manifold PN 400		
		NPT
1/2" female	IV2R4N-B-SS	65-255
Two valve manifold PN 400		
		NPT
1/2" female x direct mount	IVM2D4N-A-SS	65-251
Two valve manifold PN 400		
		NPT
1/2" female x male	IV2GM4N-SS	65-248
Two valve manifold PN 400 with swivel		
1/2" M. NPT x 1/2" F. BSPP	IV2GM4N-4PSWF-SS	65-246
Three valve manifold PN 400		
		NPT
1/2" female	IV3R4N-SS	65-277
Three valve manifold PN 400		
		NPT
1/2" female x direct mount	IVM3D4N-SS	65-265
Three valve manifold PN 400		
		NPT
1/2" female x direct mount	3VDTH15NS-V	65-273
Valve manifold PN 400 direct mount with welding connection		
2-valve, 21,3/100 mm		65-253
5-valve, 21,3/100 mm		65-295
Five valve manifold PN 400		
		NPT
1/2" female	IV5R4N-SS	65-293
Five valve manifold PN 400		
		NPT
1/2" female x direct mount	IVM5D4N-SS	65-285
1/2" female x direct mount	IVM5D4N-A-SS	65-281



I . A . C . Komponenter AB

International Automation Components

P.O Box 60, S-566 22 Habo Phone: +46 (0)36 477 00 Fax: +46 (0)36 477 15

E-mail: habo@iackomp.se www.iackomp.se

Flow Regulators & Gauges

Flow regulators

- Meiflow • The flow regulator produce fixed flow even if the pressure changes

Gauges

- We offer small plastic and metal gauges up to process gauges in stainless steel and for high pressure

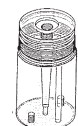

Size	Part.No.
Flow regulator Meiflow	
Water 400 0.04 - 0.4 lit/min	stainless PN 40 71-011
Water 1 0.1 - 1.0 lit/min	stainless PN 40 71-012
Air 5 1.0 - 5.0 lit/min	stainless PN 40 71-014
Water 400 0.04 - 0.4 lit/min	delrin 71-051
Water 1 0.1 - 1.0 lit/min	delrin 71-052
Indicator complete	
W 200 Part 7-8,10-15	71-055
W 400 Part 7-8,10-15	71-056
W1 Part 7-8,10-15	71-057
A5 Part 7-8,10-15	71-058
Indicator	
W 400 Part 12	71-063
W 1 Part 12	71-064
Membrane	
W200, W400, W1, A5 Part 6	71-070
Measuring plug	
W200, W400, A5 Part 7	71-071
W1 Part 7	71-072
Float	
W200, W400, W1, Part 8	71-075
O-ring	
Part 10	71-080
Part 11	71-081
Flow disc	
W1, Part 5	71-069
Gauge with connection down	
0- 6 bar 40 mm 1/8" plastic	22-102
0-12 bar 40 mm 1/8" plastic	22-104
Gauge with connection back	
0- 4 bar 40 mm 1/8" plastic	22-105
0- 6 bar 40 mm 1/8" plastic	22-106
0-10 bar 40 mm 1/8" plastic	22-107
0-12 bar 40 mm 1/8" plastic	22-108
Gauge with connection back	
0-4 bar 40 mm 1/8" metal	22-005
0-4 bar 50 mm 1/8" metal	22-006



I . A . C . Komponenter AB

International Automation Components

P.O Box 60, S-566 22 Habo Phone: +46 (0)36 477 00 Fax: +46 (0)36 477 15

E-mail: habo@iackomp.se www.iackomp.se

Flow Regulators & Gauges

Flow regulators

- Meiflow • The flow regulator produce fixed flow even if the pressure changes

Gauges

- We offer small plastic and metal gauges up to process gauges in stainless steel and for high pressure



Size	Part.No.
Gauge max 400 bar Stainless body	
Ø 63 mm, 1/4" Connection brass, bottom entry, *	22-410
Ø 63 mm, 1/4" Connection brass, back entry, *	22-415
Gauge max 400 bar Stainless body	
Ø 63 mm, 1/4" Connection stainless, bottom entry, *	22-420
Ø 63 mm, 1/4" Connection stainless, back entry, *	22-425
Gauge max 1000 bar Stainless body	
Ø 63 mm, 1/4" Connection stainless, bottom entry, *	22-430
Ø 63 mm, 1/4" Connection stainless, back entry, *	22-435
Gauge max 400 bar Stainless body	
Ø 100 mm, 1/2" Connection stainless, bottom entry, *	22-440
Ø 100 mm, 1/2" Connection stainless, back entry, *	22-445
Gauge max 1000 bar Stainless body	
Ø 100 mm, 1/2" Connection stainless, bottom entry, *	22-450
Ø 100 mm, 1/2" Connection stainless, back entry, *	22-455
Digital display	
For Pressuretransmitter 4-20mA	22-471

* Please advice pressure rate at order



I . A . C . Komponenter AB

I n t e r n a t i o n a l A u t o m a t i o n C o m p o n e n t s

P.O Box 60, S-566 22 Habo Phone: +46 (0)36 477 00 Fax: +46 (0)36 477 15

E-mail: habo@iackomp.se www.iackomp.se

Flow Regulators & Gauges

Gauge accessories

- Below you will find some recommendations to connect gauges to tubes, valves, etc.

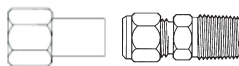

Size

Part.No.

Female Stud Standpipe Adaptor + Male Connector BSPP

1/4" female x Tube 6 OD	42-462
6 mm x 1/4" male	42-301
1/2" female x Tube 12 OD	42-479
12 mm x 1/2" male	42-312

Other dimensions - see Tube fittings



Female Connector

BSPP

6 mm x 1/4" female	42-317
12 mm x 3/8" female	42-324
12 mm x 1/2" female	42-325

Other dimensions - see Tube fittings



Gauge adaptor swivel

1/2" female BSPP x 1/2" male NPT	61-6492
----------------------------------	---------

Other dimensions - see Needle valves



Gauge nipple

1/2" male BSPP x 1/2" male NPT	61-192
--------------------------------	--------

Other dimensions - see Needle valves



Gauge needle valve PN 400

NPT

1/2" female x male	61-648
--------------------	--------



Packing for Gauge

1/4" copper	87-110
1/2" copper	87-112
1/4" SS 316	87-010
1/2" SS 316	87-012

Other dimensions - see Packings and Seals



I . A . C . Komponenter AB

International Automation Components

P.O Box 60, S-566 22 Habo Phone: +46 (0)36 477 00 Fax: +46 (0)36 477 15

E-mail: habo@iackomp.se www.iackomp.se

Bolt and nuts

- We offer many different types of bolt and nuts. If you can't find what you are looking for, please contact us.
- Stainless steel SS 316 - 2343 (A4)



Size	Part.No.
Hexagon bolts	SS 316
M5 x 10 mm	84-2005
M5 x 20 mm	84-203
M5 x 25 mm	84-204
M5 x 30 mm	84-205
M5 x 50 mm	84-207
M6 x 8 mm	84-210
M6 x 10 mm	84-2105
M6 x 12 mm	84-211
M6 x 16 mm	84-212
M6 x 20 mm	84-213
M6 x 25 mm	84-214
M6 x 30 mm	84-215
M6 x 35 mm	84-2155
M6 x 40 mm	84-216
M6 x 45 mm	84-2165
M6 x 50 mm	84-217
M6 x 70 mm	84-2183
M6 x 80 mm	84-2185
M8 x 12 mm	84-221
M8 x 16 mm	84-222
M8 x 20 mm	84-223
M8 x 25 mm	84-224
M8 x 30 mm	84-225
M8 x 40 mm	84-226
M8 x 45 mm	84-2265
M8 x 50 mm	84-227
M8 x 60 mm	84-228
M8 x 70 mm	84-2283
M10 x 20 mm	84-233
M10 x 35 mm	84-2365
M10 x 40 mm	84-237
M10 x 50 mm	84-2373



Nuts	SS 316
M4	84-264
M5	84-265
M6	84-266
M8	84-268
M10	84-270



Screw	SS 316
M3 x 16 mm	84-402
M4 x 16 mm	84-407
M4 x 20 mm	84-408
M4 x 25 mm	84-409
M5 x 12 mm	84-411
M5 x 20 mm	84-413
M6 x 20 mm	84-423
M6 x 25 mm	84-424
M6 x 30 mm	84-425
M6 x 35 mm	84-4255
M6 x 40 mm	84-426
M6 x 45 mm	84-4265
M6 x 50 mm	84-427



I . A . C . Komponenter AB

International Automation Components

P.O Box 60, S-566 22 Habo Phone: +46 (0)36 477 00 Fax: +46 (0)36 477 15

E-mail: habo@iackomp.se www.iackomp.se

Bolt & Nuts

Bolt and nuts

- We offer many different types of bolt and nuts. If you can't find what you are looking for, please contact us.
- Stainless steel SS 316 - 2343 (A4)

Size	Part.No.
Female hex.screw	
M6 x 20 mm	84-453
M6 x 25 mm	84-454
M6 x 30 mm	84-455
M6 x 35 mm	84-4555
M6 x 40 mm	84-456
M6 x 45 mm	84-457
M10 x 12 mm	57-095
Screw for wood	
8 x 65 mm FZV	84-506
Through bolt	
M6 x 40 mm FZB	84-110
M8 x 50 mm FZB	84-111
Through bolt	
M8 x 50 mm	84-131
Washer	
4,3 x 12 x 1,0 mm	84-492
5,3 x 15 x 1,2 mm	84-493
6,4 x 18 x 1,6 mm	84-494
8,4 x 24 x 2,0 mm	84-495
10,5 x 30 x 2,5 mm	84-496
Washer	
4,3 x 9 x 0,8 mm	84-482
5,3 x 10 x 1,0 mm	84-483
6,4 x 12 x 1,6 mm	84-484
8,4 x 16 x 1,6 mm	84-485
10,5 x 21 x 2,0 mm	84-486
Nut with flange	
M8	84-288
M10	84-290
Bolt with tip	
M8 x 25 mm	84-352
M8 x 30 mm	84-350
M8 x 40 mm	84-354
Cross Screw MRX	
M5 x 16 mm	84-312
M5 x 20 mm	84-313
M5 x 25 mm	84-314
M5 x 30 mm	84-315













I . A . C . Komponenter AB
International Automation Components

P.O Box 60, S-566 22 Habo Phone: +46 (0)36 477 00 Fax: +46 (0)36 477 15
E-mail: habo@iackomp.se www.iackomp.se

Packing & Seals

Packing and seals

- We offer many different types of packing and seals. If you can't find what you are looking for, please contact us.

Size	Part.No.
Packing for pipe threads	
	1/8" copper 87-099
	1/4" copper 87-100
	3/8" copper 87-101
	1/2" copper 87-102
	3/4" copper 87-103
	1" copper 87-104
	1/4" SS 316 87-001
	3/8" SS 316 87-002
	1/2" SS 316 87-003
	1/4" copper, for gauge 87-110
	3/8" copper, for gauge 87-111
	1/2" copper, for gauge 87-112
	1/4" SS 316, for gauge 87-010
	3/8" SS 316, for gauge 87-011
	1/2" SS 316, for gauge 87-012
	1/4" tredo, rubber-steel 87-301
	3/8" tredo, rubber-steel 87-302
	1/2" tredo, rubber-steel 87-303
	3/4" tredo, rubber-steel 87-304
	1/4" "NBR" plastic 87-401
	3/8" "NBR" plastic 87-402
	1/2" "NBR" plastic 87-403
	3/4" "NBR" plastic 87-404
	1" "NBR" plastic 87-405
Packing box manifolds	
	TEFLON klinger 87-356
	PTFE Ives 87-375
	GRAPHOIL Ives 87-376
	PTFE Alco 87-385
Packing manifolds	
	Klinger-A 24x18x3 PTFE 87-350
	Klinger-B 18,72x2,62 O-ring 87-351
	Ives 24x18x2,7 PTFE 87-370
	Ives 25x19x3 PTFE 87-3701
	Alco 22x19x2 PTFE 87-380
	Safelok 25x18x3,5 PTFE 87-390
Tape for thread	
	12m x 12mm x 0,075mm PTFE 86-001
	5m x 12mm x 0,2mm PTFE 86-003
	12m x 12mm x 0,1mm PTFE 86-005
Thread sealing	
	Loctite 577 - 50 ml 86-120
	Loctite 5400 - 50 ml 86-121
	Lubricating Oil 86-105
Zerust corrosion vapour capsule	
	30 cm VC1 - 1 year 88-010
	60 cm VC2 - 1 year 88-020
	60 cm VC2 - 2 years 88-030
	180 cm VC6 - 2 years 88-040



I . A . C . Komponenter AB

International Automation Components

P.O. Box 60, S-566 22 Habo Phone: +46 (0)36 477 00 Fax: +46 (0)36 477 15

E-mail: habo@iackomp.se www.iackomp.se

Electrical Cables & Glands

Electrical cable

- FKAR- PG, TG also available in blue.

Size	E-No.	Part.No.
Crosswire		
2 x 22 AWG orange/green-orange		07-100
2 x 22 AWG yellow/blue-yellow		07-101
2 x 22 AWG blue/yellow		07-105
Crosswire		
2 x 0.5 mm ² blue/red		07-110
2 x 0.5 mm ² red/white		07-111
2 x 0.5 mm ² brown/white		07-112
2 x 0.5 mm ² blue/white		07-113
2 x 0.5 mm ² orange/white		07-114
2 x 0.5 mm ² blue/yellow		07-115
2 x 0.5 mm ² white/white No.markt 1-2		07-120
Signal cable FKAR – PG		
2 x 0.5 mm ²	E01 721 20	07-031
2 x 2 x 0.5 mm ²	E01 721 30	07-032
4 x 2 x 0.5 mm ²	E01 727 30	07-033
8 x 2 x 0.5 mm ²	E01 727 70	07-034
16 x 2 x 0.5 mm ²	E01 728 30	07-035
24 x 2 x 0.5 mm ²	E01 728 60	07-036
48 x 2 x 0.5 mm ²	E01 728 90	07-037
Signal cable FKAR – TG		
3 x 1.0 mm ²	E01 741 20	07-039
Signal cable FQAR – PG halogen free		
2 x 0.5 mm ²	E01 821 20	07-531
2 x 2 x 0.5 mm ²	E01 821 30	07-532
2 x 1.0 mm ²	E01 829 20	07-538
Control cable		
KJAAM 2 x (2+1) x 0.5 mm ²		07-305
ÖLFLEX 4 x 1.0 mm ²		07-315
Control cable - EKFR		
7 x 1.5 mm ²	E01 538 20	07-048
10 x 1.5 mm ²	E01 538 40	07-049
14 x 1.5 mm ²	E01 538 60	07-050
19 x 1.5 mm ²	E01 538 80	07-051
27 x 1.5 mm ²	E01 539 10	07-052
37 x 1.5 mm ²	E01 539 40	07-053
Control cable - EKLR		
7 x 1.5 mm ²	E01 588 20	07-040
14 x 1.5 mm ²	E01 588 60	07-042
37 x 1.5 mm ²	E01 569 40	07-045
48 x 1.5 mm ²	E01 589 80	07-046
61 x 1.5 mm ²	E01 569 70	07-047

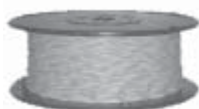

I . A . C . Komponenter AB

International Automation Components

P.O Box 60, S-566 22 Habo Phone: +46 (0)36 477 00 Fax: +46 (0)36 477 15

E-mail: habo@iackomp.se www.iackomp.se

Electrical Cables & Glands

Electrical cable and Cable gland

- We offer many different types of cable glands
- The EMC-cable gland secure the connection between the cable shield and the sheet steel in the cabinet
- EMC - Electromagnetic Compatibility



Size	Part.No.
------	----------

Electrical cable - EKLK

3G 1.5	08-003
3G 2.5	08-005
4G 1.5	08-007
4G 2.5	08-008
5G 1.5	08-010
5G 2.5	08-011



Cable gland

18.6 x 1/2"	nickel plated	05-010
18.6/PG11	polyamide	05-051
20.4/PG13	polyamide	05-052
54/PG42	polyamide	05-057
15.2/PG9	polyamide longer thread	05-060
18.6/PG11	polyamide longer thread	05-061
20.4/PG13	polyamide longer thread	05-062
22.5/PG16	polyamide longer thread	05-063
28.3/PG21	polyamide longer thread	05-064
37/PG29	polyamide longer thread	05-065



Nut

15.2/PG9	nickel plated	05-075
18.6/PG11	nickel plated	05-076
20.4/PG13	nickel plated	05-077
22.5/PG16	nickel plated	05-078
28.3/PG21	nickel plated	05-079
37/PG29	nickel plated	05-080
54/PG42	nickel plated	05-082
15.2/PG9	polyamide	05-085
18.6/PG11	polyamide	05-086
20.4/PG13	polyamide	05-087
22.5/PG16	polyamide	05-088
28.3/PG21	polyamide	05-089
37/PG29	polyamide	05-090
54/PG42	polyamide	05-092



EMC-Cable gland

22.5/PG16	nickel plated	05-305
28.3/PG21	nickel plated	05-306
37/PG29	nickel plated	05-307
47/PG36	nickel plated	05-308



EMC-Nut

22.5/PG16	nickel plated	05-325
28.3/PG21	nickel plated	05-326
37/PG29	nickel plated	05-327
47/PG36	nickel plated	05-328



I . A . C . Komponenter AB

International Automation Components











P.O Box 60, S-566 22 Habo Phone: +46 (0)36 477 00 Fax: +46 (0)36 477 15

E-mail: habo@iackomp.se www.iackomp.se

Tools & Accessories

Tools and accessories

- We offer many different types of tools and accessories. If you can't find what you are looking for, please contact us.

	Product	Part.No.
	Unjacket Tool 4,2 - 25 mm	91-012
	Cableknife Cableknife For use on Osnaline cable	91-013
	Tube cutter for plastic tube Plastic 1-15 mm Extra edge	91-031 91-035
	Welding electrode 1,6 x 300 mm OK 63.30 2,0 x 300 mm OK 63.30	91-101 91-102
	Cut-off wheel for steel 125 x 1,0 x 22 Mega-Line 125 x 1,6 x 22 Mega-Line 125 x 2,0 x 22 Mega-Line 180 x 2,0 x 22 Mega-Line	93-0020 93-0022 93-0025 93-0042
	Flap disc for steel 125 x 22 XT Rak Z80 125 x 22 Ciafiber Rak Z80	93-1139 93-1173
	Clean disc wheel 150 x 13 x 8 black 150 x 13 x 8 blue 150 x 13 x 8 purple 150 x 13 x 8 orange	93-1434 93-1451 93-1452 93-1455
	Clean disc wheel 115 x 22 rak orange	93-1417
	Hacksaw blade 300 x 18 teeth/inch 300 x 24 teeth/inch 300 x 32 teeth/inch	91-403 91-404 91-405
	Gloves Lether Tegera size 8 Lether Tegera size 10 Lether size female Lether size male	91-913 91-915 91-901 91-902



I . A . C . Komponenter AB

International Automation Components

P.O Box 60, S-566 22 Habo Phone: +46 (0)36 477 00 Fax: +46 (0)36 477 15
E-mail: habo@iackomp.se www.iackomp.se

Tools & Accessories

Tools and accessories

- We offer many different types of tools and accessories. If you can't find what you are looking for, please contact us.

Product	Part.No.
Tube cutter for metal tube	
6 - 35 mm EGO 735	91-017
Extra edge for steel, 735-750	91-019
Extra edge for steel, 753	91-020
Tube cutter for metal tube	
6 - 35 mm Ridgid 150	91-021
6 - 60 mm Ridgid 205	91-023
Extra edge for steel, Ridgid E-4546	91-025
Tube cutter for metal tube	
6 - 35 mm 6635-1	91-027
Extra edge for steel, 6635-1	91-029
Inner-Outer Reamers for metal tube	
6 - 35 mm	91-041
Deburring tool	
Deburring tool	91-042
Stepdrill	
4 - 30 mm	91-043
Tube bender	
6 mm - Ridgid 406M	91-051
8 mm - Ridgid 408M	91-052
Tube bender	
10 mm - Ridgid 310M	91-055
12 mm - Ridgid 312M	91-056
Bockverktyg för rör	
10 mm - Ridgid 610M	91-045
12 mm - Ridgid 612M	91-046
Tube bender high geared	
3/4" - Ridgid 368 (18-19mm)	91-059
Tube bender	
6 mm - MS-HTB-6M	91-061
8 mm - MS-HTB-8M	91-062
10 mm - MS-HTB-10M	91-063
12 mm - MS-HTB-12M	91-064



I . A . C . Komponenter AB

International Automation Components

P.O Box 60, S-566 22 Habo Phone: +46 (0)36 477 00 Fax: +46 (0)36 477 15

E-mail: habo@iackomp.se www.iackomp.se

Tools & Accessories

Tools and accessories

- We offer many different types of tools and accessories. If you can't find what you are looking for, please contact us.



Product

Part.No.

Electrical Tube bender

18-22-28 mm Robend 4000

91-0705



Former set tube Robend 3000/4000

12 mm (guide shoe incl.)	91-071
14 mm "	91-072
15 mm "	91-073
16 mm "	91-074
18 mm "	91-075
20 mm "	91-076
22 mm "	91-077
1" - 25 mm "	91-078
28 mm "	91-079
1 1/4" - 32 mm "	91-0795

Guide shoe Robend 3000/4000



12 mm	91-081
14 mm	91-082
15 mm	91-083
16 mm	91-084
18 mm	91-085
20 mm	91-086
22 mm	91-087
1" - 25 mm	91-088
28 mm	91-089
1 1/4" - 32 mm	91-0895

Tripod for Robend



Tripod	91-068
Tripod Extension 500mm	91-069

Bar handle



L = 400 mm	91-090
------------	--------

Cone tool



16 mm ID	91-092
25 mm ID	91-096

Open ring ratchet



19 mm	91-245
22 mm	91-248

Open ring ratchet



19 x 22 mm	91-255
------------	--------



I . A . C . Komponenter AB

International Automation Components

P.O Box 60, S-566 22 Habo Phone: +46 (0)36 477 00 Fax: +46 (0)36 477 15

E-mail: habo@iackomp.se www.iackomp.se

Tools & Accessories

Tools and accessories

- We offer many different types of tools and accessories. If you can't find what you are looking for, please contact us.



Product	Part.No.
Release tool for tube	
4 - 14 mm	91-005
3 - 10 mm	91-006



I . A . C . Komponenter AB

International Automation Components

P.O Box 60, S-566 22 Habo Phone: +46 (0)36 477 00 Fax: +46 (0)36 477 15

E-mail: habo@iackomp.se www.iackomp.se