

Innehållsförteckning

Produkter	Grupp
▶ Rörkopplingar	1
▶ Rördelar	2
▶ Rör	3
▶ Fästdetaljer	4
▶ Pneumatisk kabel & slang	5
▶ Slangkopplingar	6
▶ Luftfördelning	7
▶ Luftbehandling	8
▶ Pneumatiska ventiler	9
▶ Skåp, lådor & tillbehör	10
▶ Analyshus & bodar	11
▶ Ventiler	12
▶ Ventilblock	13
▶ Flödesregulator & manometer	14
▶ Bult & skruv	15
▶ Packning & tätning	16
▶ Elkabel & förskruvning	17
▶ Verktyg & tillbehör	18



I.A.C. Komponenter AB

International Automation Components

P.O. Box 60, S-566 22 Habo • Phone: +46 (0)36 477 00 • Fax: +46 (0)36 477 15

E-mail: habo@iackomp.se • www.iackomp.se • Reg.No. 556461-2983



Certificate No 488/94

Rörkopplingar

Klämringskopplingar

- Fabrikat: Safelok • Syrafast stål 316 - 2343 • NPT - Amerikansk konisk rörgänga
- BSPP (R) - Europeisk cylindrisk rörgänga • BSPT (KR) - Europeisk konisk rörgänga
- Finns även i tumdimension och i 3, 4, 20, 22, 25 mm.

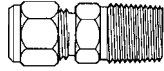

Rördim. x gänga	Typnr.	Artikelnummer		
Rak anslutning utv. gänga		NPT	BSPP	BSPT
3 mm x 1/8"	3m MC2	42-120	42-130	*
3 mm x 1/4"	3m MC4	42-121	42-131	*
6 mm x 1/8"	6m MC2	42-200	42-300	42-800
6 mm x 1/4"	6m MC4	42-201	42-301	42-801
6 mm x 3/8"	6m MC6	42-202	42-303	42-802
6 mm x 1/2"	6m MC8	42-203	42-302	42-803
8 mm x 1/8"	8m MC2	42-204	42-304	42-804
8 mm x 1/4"	8m MC4	42-205	42-307	42-805
8 mm x 3/8"	8m MC6	42-2051	42-3071	42-8051
8 mm x 1/2"	8m MC8	42-2052	*	*
10 mm x 1/4"	10m MC4	42-206	42-308	42-806
10 mm x 3/8"	10m MC6	42-207	42-309	42-807
10 mm x 1/2"	10m MC8	42-208	42-306	42-808
12 mm x 1/4"	12m MC4	42-210	42-310	42-810
12 mm x 3/8"	12m MC6	42-211	42-311	42-811
12 mm x 1/2"	12m MC8	42-212	42-312	42-812
12 mm x 3/4"	12m MC12	42-213	42-313	42-813
15 mm x 3/8"	15m MC6	42-2132	42-3131	42-814
15 mm x 1/2"	15m MC8	42-2133	42-3132	42-815
16 mm x 3/8"	16m MC6	*	42-3134	*
16 mm x 1/2"	16m MC8	42-2136	42-3135	42-8152
18 mm x 1/2"	18m MC8	42-214	42-314	*
18 mm x 3/4"	18m MC12	42-2141	42-3141	42-8141
20 mm x 3/8"	20m MC6	42-2143	42-3143	*
20 mm x 1/2"	20m MC8	42-2144	42-3144	*
20 mm x 3/4"	20m MC12	42-2145	42-3145	*
22 mm x 1/2"	22m MC8	42-215	42-315	*
22 mm x 3/4"	22m MC12	42-2151	42-3151	*
25 mm x 3/8"	25m MC6	42-2155	42-3155	*
25 mm x 1/2"	25m MC8	42-2156	42-3156	*
25 mm x 3/4"	25m MC12	42-2157	42-3157	*
25 mm x 1"	25m MC16	42-2158	42-3158	*
Rak anslutning utv. gänga med o-ringstättning		BSPP		
6 mm x 1/8"	6m MC2-OR	42-900		
6 mm x 1/4"	6m MC4-OR	42-901		
6 mm x 3/8"	6m MC6-OR	42-902		
12 mm x 1/4"	12m MC4-OR	42-910		
12 mm x 3/8"	12m MC6-OR	42-911		
12 mm x 1/2"	12m MC8-OR	42-912		
Rak anslutning inv. gänga		NPT	BSPP	BSPT
6 mm x 1/8"	6m FC2	42-216	42-316	42-816
6 mm x 1/4"	6m FC4	42-217	42-317	42-817
6 mm x 3/8"	6m FC6	*	42-318	*
8 mm x 1/8"	8m FC2	42-2182	*	42-818
8 mm x 1/4"	8m FC4	42-219	42-319	42-819
10 mm x 1/4"	10m FC4	42-221	42-321	42-820
10 mm x 3/8"	10m FC6	42-222	42-326	42-821
10 mm x 1/2"	10m FC8	42-2221	*	42-822
12 mm x 1/4"	12m FC4	42-223	42-323	42-823
12 mm x 3/8"	12m FC6	42-224	42-324	42-824
12 mm x 1/2"	12m FC8	42-225	42-325	42-825

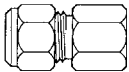

forts.

* mot order



I.A.C. Komponenter AB

International Automation Components

P.O. Box 60, S-566 22 Habo • Phone: +46 (0)36 477 00 • Fax: +46 (0)36 477 15

E-mail: habo@iackomp.se • www.iackomp.se • Reg.No. 556461-2983



Certificate No 488/94

Rörkopplingar

Klämringskopplingar

- Fabrikat: Safelok • Syrafast stål 316 - 2343 • NPT - Amerikansk konisk rörgänga
- BSPP (R) - Europeisk cylindrisk rörgänga • BSPT (KR) - Europeisk konisk rörgänga
- Finns även i tumdimension och i 3, 4, 20, 22, 25 mm.

Rördim. x gänga Typnr.

Artikelnummer

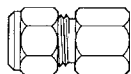

Rak anslutning inv. gänga

NPT

BSPP

BSPT

15 mm x 1/2"	15m FC8	*	42-3272	*
16 mm x 1/4"	16m FC4	42-226	42-3273	*
16 mm x 1/2"	16m FC8	42-2262	42-3275	*
18 mm x 1/2"	18m FC8	42-227	*	*
18 mm x 3/4"	18m FC12	42-2271	*	*
20 mm x 1/2"	20m FC8	42-228	*	*

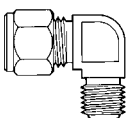

Vinkelanslutning utv. gänga

NPT

BSPP

BSPT

6 mm x 1/8"	6m ME2	42-230	42-330	42-830
6 mm x 1/4"	6m ME4	42-231	42-331	42-831
6 mm x 3/8"	6m ME6	42-232	*	*
8 mm x 1/8"	8m ME2	42-2322	*	42-832
8 mm x 1/4"	8m ME4	42-233	42-333	42-833
8 mm x 3/8"	8m ME6	42-2331	*	*
8 mm x 1/2"	8m ME8	42-2332	*	*
10 mm x 1/4"	10m ME4	42-234	42-339	42-834
10 mm x 3/8"	10m ME6	42-235	42-340	42-835
10 mm x 1/2"	10m ME8	42-2351	*	42-836
12 mm x 1/4"	12m ME4	42-238	42-341	42-837
12 mm x 3/8"	12m ME6	42-236	42-336	42-838
12 mm x 1/2"	12m ME8	42-237	42-337	42-839
15 mm x 3/8"	15m ME6	42-2372	*	*
15 mm x 1/2"	15m ME8	42-2373	*	*
16 mm x 3/8"	16m ME6	*	42-3414	*
16 mm x 1/2"	16m ME8	42-240	42-3415	42-8395
18 mm x 1/2"	18m ME8	42-2375	42-342	42-840
18 mm x 3/4"	18m ME12	42-2376	*	*
20 mm x 3/8"	20m ME6	42-2423	42-3423	*
20 mm x 1/2"	20m ME8	42-2424	42-3424	*
20 mm x 3/4"	20m ME12	42-2425	42-3425	*
22 mm x 1/2"	22m ME8	42-243	42-343	*
22 mm x 3/4"	22m ME12	42-2431	42-3431	*
25 mm x 3/8"	25m ME6	42-2435	42-3435	*
25 mm x 1/2"	25m ME8	42-2436	42-3436	*
25 mm x 3/4"	25m ME12	42-2437	42-3437	*

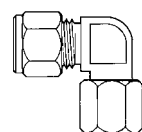

Vinkelanslutning inv. gänga

NPT

BSPP

BSPT

6 mm x 1/8"	6m FE2	42-105	*	*
6 mm x 1/4"	6m FE4	42-106	*	*
8 mm x 1/8"	8m FE2	42-107	*	*
8 mm x 1/4"	8m FE4	42-108	*	*
10 mm x 1/8"	10m FE2	42-109	*	*
10 mm x 1/4"	10m FE4	42-110	*	*
10 mm x 3/8"	10m FE6	42-1101	*	*
12 mm x 1/4"	12m FE4	42-111	*	*
12 mm x 3/8"	12m FE6	42-112	*	*
12 mm x 1/2"	12m FE8	42-113	42-137	*

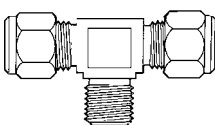

T-anslutning utv. gänga

NPT

BSPP

BSPT

6 mm x 1/8"	6m TTM2	42-270	42-370	*
6 mm x 1/4"	6m TTM4	42-271	42-371	*
8 mm x 1/4"	8m TTM4	42-272	42-372	*
10 mm x 1/4"	10m TTM4	42-273	42-373	*
12 mm x 3/8"	12m TTM6	42-276	42-376	*
12 mm x 1/2"	12m TTM8	42-277	42-377	*
16 mm x 1/2"	16m TTM8	42-2776	*	*
18 mm x 3/4"	18m TTM12	42-2781	*	*



I.A.C. Komponenter AB

International Automation Components

P.O. Box 60, S-566 22 Habo • Phone: +46 (0)36 477 00 • Fax: +46 (0)36 477 15

E-mail: habo@iackomp.se • www.iackomp.se • Reg.No. 556461-2983



Certificate No 488/94

Rörkopplingar

Klämringskopplingar

- Fabrikat: Safelok • Syrafast stål 316 - 2343 • NPT - Amerikansk konisk rörgänga
- BSPP (R) - Europeisk cylindrisk rörgänga • BSPT (KR) - Europeisk konisk rörgänga
- Finns även i tumdimension och i 3, 4, 20, 22, 25 mm.

Rördimension	Typnr.	Artikelnummer		
L-anslutning utv. gänga				
6 mm x 1/8"	6m TMT2	42-280	42-290	*
6 mm x 1/4"	6m TMT4	42-281	42-291	*
8 mm x 1/4"	8m TMT4	42-283	42-293	*
10 mm x 1/4"	10m TMT4	42-284	42-294	*
12 mm x 3/8"	12m TMT6	42-286	42-296	42-886
12 mm x 1/2"	12m TMT8	42-287	42-297	42-887
16 mm x 1/2"	16m TMT8	42-2876	*	*
18 mm x 3/4"	18m TMT12	42-2881	*	*
Skottgenomföring utv. gänga				
12 mm x 1/4"	12m MBH4	42-4905	*	*
12 mm x 3/8"	12m MBH6	42-491	*	42-853
12 mm x 1/2"	12m MBH8	42-490	*	*
Skottgenomföring inv. gänga				
10 mm x 1/4"	10m FBH4	42-494	*	*
12 mm x 1/2"	12m FBH8	42-495	*	*
Skarvkoppling rak				
6 mm	6m U		42-244	
8 mm	8m U		42-245	
10 mm	10m U		42-247	
12 mm	12m U		42-246	
15 mm	15m U		42-2473	
16 mm	16m U		42-2471	
18 mm	18m U		42-2472	
20 mm	20m U		42-2474	
22 mm	22m U		42-2475	
25 mm	25m U		42-248	
Skarvkoppling vinkel				
6 mm	6m ELU		42-250	
8 mm	8m ELU		42-251	
10 mm	10m ELU		42-252	
12 mm	12m ELU		42-253	
15 mm	15m ELU		42-2533	
16 mm	16m ELU		42-2534	
18 mm	18m ELU		42-2532	
20 mm	20m ELU		42-2536	
22 mm	22m ELU		42-2535	
25 mm	25m ELU		42-254	
T-koppling				
6 mm	6m TTT		42-264	
8 mm	8m TTT		42-265	
10 mm	10m TTT		42-266	
12 mm	12m TTT		42-267	
15 mm	15m TTT		42-2673	
16 mm	16m TTT		42-268	
18 mm	18m TTT		42-269	
20 mm	20m TTT		42-2693	
22 mm	22m TTT		42-2695	
25 mm	25m TTT		42-2698	

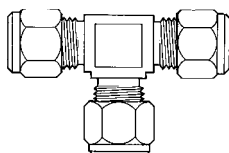
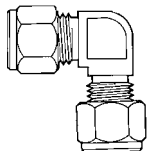
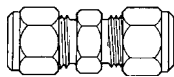
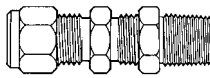
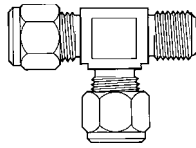

I.A.C. Komponenter AB

International Automation Components

P.O. Box 60, S-566 22 Habo • Phone: +46 (0)36 477 00 • Fax: +46 (0)36 477 15

E-mail: habo@iackomp.se • www.iackomp.se • Reg.No. 556461-2983



Certificate No 488/94

Rörkopplingar

Klämringskopplingar

- Fabrikat: Safelok • Syrafast stål 316 - 2343 • NPT - Amerikansk konisk rörgänga
- BSPP (R) - Europeisk cylindrisk rörgänga • BSPT (KR) - Europeisk konisk rörgänga
- Finns även i tumdimension och i 3, 4, 20, 22, 25 mm.

Rördim. x gänga	Typnr.	Artikelnummer
-----------------	--------	---------------

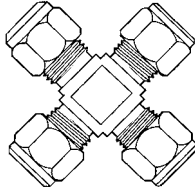

Korskoppling

6 mm	6m UC	42-344
8 mm	8m UC	42-345
10 mm	10m UC	42-346
12 mm	12m UC	42-347

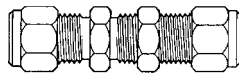

Skottgenomföring

6 mm	6m BHU	42-256
8 mm	8m BHU	42-257
10 mm	10m BHU	42-258
12 mm	12m BHU	42-259
15 mm	15m BHU	42-260
16 mm	16m BHU	42-2605
18 mm	18m BHU	42-261

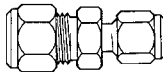

Reduceringskoppling

8 mm x 6 mm	8m RU6	42-350
10 mm x 6 mm	10m RU6	42-351
10 mm x 8 mm	10m RU8	42-3512
12 mm x 6 mm	12m RU6	42-352
12 mm x 8 mm	12m RU8	42-3522
12 mm x 10 mm	12m RU10	42-353
16 mm x 12 mm	16m RU12	42-354
18 mm x 12 mm	18m RU12	42-355

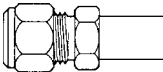

Reduceringsadapter

6 mm x rör 8 YD	6m RED8	42-360
6 mm x rör 10 YD	6m RED10	42-361
6 mm x rör 12 YD	6m RED12	42-362
8 mm x rör 10 YD	8m RED10	42-364
8 mm x rör 12 YD	8m RED12	42-365
10 mm x rör 12 YD	10m RED12	42-363
12 mm x rör 16 YD	12m RED16	42-366
12 mm x rör 18 YD	12m RED18	42-367
18 mm x rör 12 YD	18m RED12	42-368

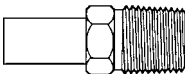

Kopplingsadapter utv. gänga

		NPT	BSPP	BSPT
Rör 6 YD x 1/8"	6m ATPM2	*	42-431	*
Rör 6 YD x 1/4"	6m ATPM4	*	42-432	42-412
Rör 6 YD x 3/8"	6m ATPM6	*	42-433	*
Rör 6 YD x 1/2"	6m ATPM8	42-404	42-434	*
Rör 8 YD x 1/4"	8m ATPM4	*	42-437	*
Rör 10 YD x 1/4"	10m ATPM4	*	42-442	*
Rör 10 YD x 3/8"	10m ATPM6	*	42-443	*
Rör 10 YD x 1/2"	10m ATPM8	*	42-444	*
Rör 12 YD x 1/4"	12m ATPM4	42-427	42-447	*
Rör 12 YD x 3/8"	12m ATPM6	42-428	42-448	42-430
Rör 12 YD x 1/2"	12m ATPM8	42-429	42-449	*
Rör 16 YD x 1/2"	16m ATPM8	42-4295	*	*

Kopplingsadapter utv. gänga med o-ringstättning BSPP

Rör 6 YD x 1/8"	6m ATPM2-OR	42-980
Rör 6 YD x 1/4"	6m ATPM4-OR	42-981
Rör 12 YD x 1/4"	12m ATPM4-OR	42-990
Rör 12 YD x 3/8"	12m ATPM6-OR	42-991
Rör 12 YD x 1/2"	12m ATPM8-OR	42-992

* mot order



I.A.C. Komponenter AB

International Automation Components

P.O. Box 60, S-566 22 Habo • Phone: +46 (0)36 477 00 • Fax: +46 (0)36 477 15

E-mail: habo@iackomp.se • www.iackomp.se • Reg.No. 556461-2983



Certificate No 488/94

Rörkopplingar

Klämringskopplingar

- Fabrikat: Safelok • Syrafast stål 316 - 2343 • NPT - Amerikansk konisk rörgänga
- BSPP (R) - Europeisk cylindrisk rörgänga • BSPT (KR) - Europeisk konisk rörgänga
- Finns även i tumdimension och i 3, 4, 20, 22, 25 mm.



Rördimension	Typnr.	Artikelnummer	
Kopplingsadapter inv. gänga		NPT	BSPP (för manometer)
Rör 6 YD x 1/8"	6m ATPF2	*	42-461
Rör 6 YD x 1/4"	6m ATPF4	*	42-462
Rör 6 YD x 1/2"	6m ATPF8	42-451	42-464
Rör 8 YD x 1/4"	8m ATPF4	*	42-467
Rör 10 YD x 1/4"	10m ATPF4	*	42-472
Rör 10 YD x 3/8"	10m ATPF6	*	42-473
Rör 10 YD x 1/2"	10m ATPF8	*	42-474
Rör 12 YD x 1/4"	12m ATPF4	42-452	42-477
Rör 12 YD x 3/8"	12m ATPF6	*	42-478
Rör 12 YD x 1/2"	12m ATPF8	*	42-479
Rör 16 YD x 1/2"	16m ATPF8	42-450	*

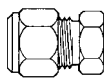

Klämringsplugg		
6 mm	6m BE	42-380
8 mm	8m BE	42-381
10 mm	10m BE	42-382
12 mm	12m BE	42-383
18 mm	18m BE	42-3835



Kopplingsplugg		
6 mm	BP 6m	42-385
8 mm	BP 8m	42-386
10 mm	BP 10m	42-387
12 mm	BP 12m	42-388
15 mm	BP 15m	42-3885
16 mm	BP 16m	42-3886
18 mm	BP 18m	42-389



Mutter		
3 mm	3m N	*
6 mm	6m N	42-390
8 mm	8m N	42-391
10 mm	10m N	42-392
12 mm	12m N	42-393
15 mm	15m N	42-3932
16 mm	16m N	42-3933
18 mm	18m N	42-3935
20 mm	20m N	42-3937
22 mm	22m N	42-3938
25 mm	25m N	42-3939



Klämringar bakre och främre (konor)		
3 mm	3m RC+FC	*
6 mm	6m RC+FC	42-395
8 mm	8m RC+FC	42-396
10 mm	10m RC+FC	42-397
12 mm	12m RC+FC	42-398
15 mm	15m RC+FC	42-399
16 mm	16m RC+FC	42-3993
18 mm	18m RC+FC	42-3995
20 mm	20m RC+FC	42-3997
22 mm	22m RC+FC	42-3998
25 mm	25m RC+FC	42-3999

Klämring teflon	
12 mm	42-3985

* mot order



I.A.C. Komponenter AB

International Automation Components

P.O. Box 60, S-566 22 Habo • Phone: +46 (0)36 477 00 • Fax: +46 (0)36 477 15

E-mail: habo@iackomp.se • www.iackomp.se • Reg.No. 556461-2983



Certificate No 488/94

Rörkopplingar

Svetskopplingar

- Fabrikat: Safelok • Syrafast stål 316 - 2343
- Andra dimensioner - mot förfrågan



Rördim. x gänga	Typnr.	Artikelnummer
-----------------	--------	---------------

Rak koppling utv. gänga med muffsvets (Socket Weld)		
---	--	--

10 mm x 1/4" NPT	10mmOD SW.MC4NPT	*
10 mm x 1/2" NPT	10mmOD SW.MC8NPT	*
12 mm x 1/4" NPT	12mmOD SW.MC4NPT	42-710
12 mm x 1/2" NPT	12mmOD SW.MC8NPT	42-712
14 mm x 1/4" NPT	14mmOD SW.MC4NPT	*
14 mm x 1/2" NPT	14mmOD SW.MC8NPT	*



Rak koppling med stumsvets (Butt Weld)		
--	--	--

10 mm x 21,3 mm	BWC10mC2x1/2"NBW	*
12 mm x 21,3 mm	BWC12mC2x1/2"NBW	42-713
14 mm x 21,3 mm	BWC14mC2x1/2"NBW	*



Skarvkoppling rak med muffsvets (Socket Weld)		
---	--	--

10 mm	10mSW U	*
12 mm	12mSW U	42-746
14 mm	14mSW U	*



T-koppling med muffsvets (Socket Weld)		
--	--	--

10 mm	10mSW TTT	*
12 mm	12mSW TTT	42-767
14 mm	14mSW TTT	*



Rak koppling utv. gänga med stumsvets (Butt Weld)		
---	--	--

21,3 mm x 3/4" NPT	1/2"NBW.MC12NPT	42-715
--------------------	-----------------	--------



Vinkelkoppling med stumsvets (Butt Weld)		
--	--	--

10 mm x 21,3 mm	BWE 12mC2x1/2"NBW	*
12 mm x 21,3 mm	BWE 12mC2x1/2"NBW	42-737
14 mm x 21,3 mm	BWE 12mC2x1/2"NBW	*



Skarvkoppling vinkel med muffsvets (Socket Weld)		
--	--	--

10 mm	10mSW ELU	*
12 mm	12mSW ELU	42-753
14 mm	14mSW ELU	*

* mot order

Svetskopplingar går även att erhålla i tryckkärlsstål 13CrMo44



I.A.C. Komponenter AB

International Automation Components

P.O. Box 60, S-566 22 Habo • Phone: +46 (0)36 477 00 • Fax: +46 (0)36 477 15

E-mail: habo@iackomp.se • www.iackomp.se • Reg.No. 556461-2983



Certificate No 488/94

Rörkopplingar

Gångor klämringkopplingar

• Fabrikat: Safelok • Syrafast stål 316 - 2343

Översiktstabell över standardgångor

BSPP - B.S.2779-1973 - Europeisk cylindrisk rörgänga (R)

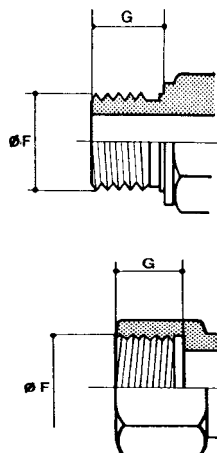

Utv. gänga

Inv. gänga

Tum	mm	Diam. F	Gängor per tum	G	Tum	mm	Diam. F	Gängor per tum	G
1/8	5,10	9,7	28	8	1/8	5,10	9,7	28	8,0
1/4	8,13	13,1	19	10	1/4	8,13	13,1	19	11,0
3/8	12,17	16,6	19	10	3/8	12,17	16,6	19	11,4
1/2	15,21	20,9	14	12	1/2	15,21	20,9	14	15,0
3/4	21,17	26,4	14	16	3/4	21,27	26,4	14	16,3
1	26,34	33,2	11	16	1	26,34	33,2	11	19,1

BSPT - B.S.21-1985 - Europeisk konisk rörgänga (KR)

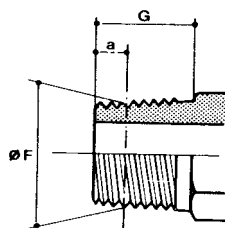

Utv. gänga

Tum	mm	Diam. F	Gängor per tum	A	G
1/8	5,10	9,7	28	4,0	9,5
1/4	8,13	13,1	19	6,0	14,3
3/8	12,17	16,6	19	6,4	14,3
1/2	15,21	20,9	14	8,2	19,1
3/4	21,27	26,4	14	9,5	19,1
1	26,34	33,2	11	10,4	23,8

NPT - ANSI B2.1 - Amerikansk konisk rörgänga

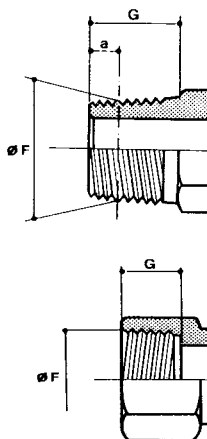

Utv. gänga

Inv. gänga

Tum	Diam. F	Gängor per tum	A	G	Tum	Diam. F	Gängor per tum	G
1/8	10,2	27	4,5	9,5	1/8	10,2	27	9,5
1/4	13,5	18	5,0	14,3	1/4	13,5	18	14,3
3/8	17,0	18	6,0	14,3	3/8	17,0	18	14,3
1/2	21,2	14	8,1	19,1	1/2	21,2	14	19,1
3/4	26,5	14	8,6	19,1				
1	33,2	11	10,6	23,8				



I.A.C. Komponenter AB

International Automation Components

P.O. Box 60, S-566 22 Habo • Phone: +46 (0)36 477 00 • Fax: +46 (0)36 477 15

E-mail: habo@iackomp.se • www.iackomp.se • Reg.No. 556461-2983

Monteringsanvisning

• Fabrikat: Safelok • Syrafast stål 316 - 2343

Monteringsanvisning

Monteringsinstruktion

"Safelok" rörkopplingar kommer ihopsatta och behöver ej tas isär vid montage.

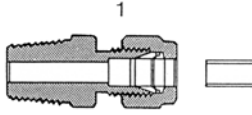

1. Kapa röret till önskad längd (snittet skall vara rakt) och avlägsna alla grader både in- och utvändigt.

2. För in den färdiga rörändan i kopplingen och kontrollera att röret bottenar ordentligt. Drag åt muttern för hand.

3. Drag därefter muttern 1 1/4 varv och kopplingen är färdigmonterad.

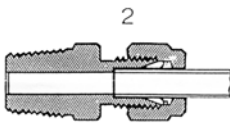

Viktigt:

Vid användning under höga tryck, impulstryck, vibrationer o.dyl., drag åt muttern tills röret inte längre vrides för hand, och därefter ytterligare 1 1/4 varv.

Demontering och återmontering

"Safelok" rörkopplingar kan tas isär och sättas ihop flera gånger utan att förbandets kvalitet försämras.

1. Kontrollera innan återmonteringen att både kopplingen och röret är rena och oskadade.

2. För in röret i kopplingen till tätningsringen kommer säkert på plats.



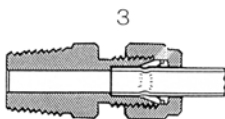

3. Drag åt muttern till det ursprungliga 1 1/4 varvs läget och sedan ytterligare någon millimeter för att helt säkerställa kopplingens täthet.



Rörkopplingar

Rör & slangkopplingar

- Fabrikat - ©: C.Matic • Syrafast stål 316 - 2343
- Instickskoppling med gripringslåsnings för plast och metallrör
- BSPT (KR) - Europeisk konisk rörgänga • BSPP (R) - Europeisk cylindrisk rörgänga
- Finns även i andra dimensioner och utföranden

Rördim. x gänga	Typnr.	Artikelnummer
Rak anslutning utv. gänga		BSPT (KR)
	6 mm x 1/8"	MX110618 47-003
	6 mm x 1/4"	MX110614 47-004
	8 mm x 1/8"	MX110818 47-005
	8 mm x 1/4"	MX110814 47-006
	8 mm x 3/8"	MX110838 47-007
	10 mm x 1/4"	MX111014 47-008
	10 mm x 3/8"	MX111038 47-009
	10 mm x 1/2"	MX111012 47-010
	12 mm x 1/4"	MX111214 47-011
	12 mm x 3/8"	MX111238 47-012
	12 mm x 1/2"	MX111212 47-0125
	Rak anslutning utv. gänga	
	6 mm x 1/8"	MX120618 47-013
	6 mm x 1/4"	MX120614 47-014
	8 mm x 1/8"	MX120818 47-015
	8 mm x 1/4"	MX120814 47-016
	8 mm x 3/8"	MX120838 47-017
	10 mm x 1/4"	MX121014 47-018
	10 mm x 3/8"	MX121038 47-019
	10 mm x 1/2"	MX121012 47-020
	12 mm x 1/4"	MX121214 47-021
	12 mm x 3/8"	MX121238 47-0215
	12 mm x 1/2"	MX121212 47-022
	Vinkelkoppling vridbar utv. gänga	
	6 mm x 1/8"	MX150618 47-023
	6 mm x 1/4"	MX150614 47-024
	8 mm x 1/8"	MX150818 47-025
	8 mm x 1/4"	MX150814 47-026
	8 mm x 3/8"	MX150838 47-027
	10 mm x 1/4"	MX151014 47-028
	10 mm x 3/8"	MX151038 47-029
	10 mm x 1/2"	MX151012 47-030
	12 mm x 1/4"	MX151214 47-031
	12 mm x 3/8"	MX151238 47-032
	12 mm x 1/2"	MX151212 47-0325
	Vinkelkoppling vridbar utv. gänga	
	6 mm x 1/8"	MX160618 47-033
	6 mm x 1/4"	MX160614 47-034
	8 mm x 1/8"	MX160818 47-035
	8 mm x 1/4"	MX160814 47-036
	8 mm x 3/8"	MX160838 47-037
	10 mm x 1/4"	MX161014 47-038
	10 mm x 3/8"	MX161038 47-039
	10 mm x 1/2"	MX161012 47-040
	12 mm x 1/4"	MX161214 47-041
	12 mm x 3/8"	MX161238 47-042
	12 mm x 1/2"	MX161212 47-0425



I.A.C. Komponenter AB

International Automation Components

P.O. Box 60, S-566 22 Habo • Phone: +46 (0)36 477 00 • Fax: +46 (0)36 477 15

E-mail: habo@iackomp.se • www.iackomp.se • Reg.No. 556461-2983

Rörkopplingar

Rör & slangkopplingar

- Fabrikat - ©: C.Matic • Syrafast stål 316 - 2343
- Instickskoppling med griplingslåsning för plast och metallrör
- BSPT (KR) - Europeisk konisk rörgänga • BSPP (R) - Europeisk cylindrisk rörgänga
- Finns även i andra dimensioner och utföranden

Rördim. x gänga	Typnr.	Artikelnummer
-----------------	--------	---------------



T-koppling vridbar utv. gänga		BSPT (KR)
-------------------------------	--	-----------

6 mm x 1/8"	MX200618	47-043
6 mm x 1/4"	MX200614	47-044
8 mm x 1/8"	MX200818	47-045
8 mm x 1/4"	MX200814	47-046
10 mm x 1/4"	MX201014	47-048
10 mm x 3/8"	MX201038	47-049
12 mm x 3/8"	MX201238	47-050
12 mm x 1/2"	MX201212	47-051



T-koppling vridbar utv. gänga		BSPP (R)
-------------------------------	--	----------

6 mm x 1/8"	MX210618	47-053
6 mm x 1/4"	MX210614	47-054
8 mm x 1/8"	MX210818	47-055
8 mm x 1/4"	MX210814	47-056
10 mm x 1/4"	MX211014	47-057
10 mm x 3/8"	MX211038	47-058
12 mm x 3/8"	MX211238	47-059
12 mm x 1/2"	MX211212	47-060



Skottgenomföring		
------------------	--	--

6 mm	MX270606	47-071
8 mm	MX270808	47-072
10 mm	MX271010	47-073
12 mm	MX271212	47-074



Reduceringsadapter		
--------------------	--	--

6 mm x YD8	MX250608	47-077
6 mm x YD10	MX250610	47-0775
8 mm x YD10	MX250810	47-078
8 mm x YD12	MX250812	47-079
10 mm x YD12	MX251012	47-080



Skarvkoppling rak		
-------------------	--	--

6 mm	MX260606	47-081
8 mm	MX260808	47-082
10 mm	MX261010	47-083
12 mm	MX261212	47-084



Skarvkoppling vinkel		
----------------------	--	--

6 mm	MX280606	47-086
8 mm	MX280808	47-087
10 mm	MX281010	47-088
12 mm	MX281212	47-089



T-koppling		
------------	--	--

6 mm	MX290606	47-091
8 mm	MX290808	47-092
10 mm	MX291010	47-093
12 mm	MX291212	47-094



I.A.C. Komponenter AB

International Automation Components

P.O. Box 60, S-566 22 Habo • Phone: +46 (0)36 477 00 • Fax: +46 (0)36 477 15

E-mail: habo@iackomp.se • www.iackomp.se • Reg.No. 556461-2983

Rörkopplingar

Skäringskopplingar för kopparrör

- Fabrikat: MSB • Mässing
- Finns även i andra dimensioner och utföranden.



Rördim. x gänga

Artikelnummer

Rak koppling utv. gänga

BSPT (KR)

6/4 mm x 1/8"	44-101
6/4 mm x 1/4"	44-102
8/6 mm x 1/4"	44-105
10/8 mm x 1/4"	44-108
12/10 mm x 3/8"	44-112
12/10 mm x 1/2"	44-113
1/4" x 1/8"	44-001
1/4" x 1/4"	44-002



Rak koppling inv. gänga

BSPP (R)

6/4 mm x 1/8"	44-116
6/4 mm x 1/4"	44-117
8/6 mm x 1/4"	44-120
10/8 mm x 1/4"	44-123
1/4" x 1/8"	44-016
1/4" x 1/4"	44-017



Vinkelkoppling utv. gänga

BSPT (KR)

6/4 mm x 1/8"	44-131
6/4 mm x 1/4"	44-132
8/6 mm x 1/4"	44-135
10/8 mm x 1/4"	44-138
12/10 mm x 3/8"	44-142
12/10 mm x 1/2"	44-143
1/4" x 1/8"	44-031
1/4" x 1/4"	44-032



T-koppling utv. gänga

BSPT (KR)

6/4 mm x 1/8"	44-146
6/4 mm x 1/4"	44-147



L-koppling utv. gänga

BSPT (KR)

6/4 mm x 1/8"	44-161
6/4 mm x 1/4"	44-162



Skarvkooppling rak

6/4 mm	44-176
8/6 mm	44-177
10/8 mm	44-178
12/10 mm	44-179
1/4"	44-076



Skarvkooppling vinkel

6/4 mm	44-181
8/6 mm	44-182
10/8 mm	44-183
12/10 mm	44-184
1/4"	44-081



I.A.C. Komponenter AB

International Automation Components

P.O. Box 60, S-566 22 Habo • Phone: +46 (0)36 477 00 • Fax: +46 (0)36 477 15
E-mail: habo@iackomp.se • www.iackomp.se • Reg.No. 556461-2983

Rörkopplingar

Skäringskopplingar för kopparrör

- Fabrikat: MSB • Mässing
- Finns även i andra dimensioner och utföranden.



Rördim. x gänga

Artikelnummer

T-koppling

6/4 mm	44-186
8/6 mm	44-187
10/8 mm	44-188
12/10 mm	44-189
1/4"	44-086



Skottgenomföring

6/4 mm	44-126
1/4"	44-026



Mutter

6/4 mm	44-191
8/6 mm	44-192
10/8 mm	44-193
12/10 mm	44-194
1/4"	44-091



Skärring

6/4 mm	44-196
8/6 mm	44-197
10/8 mm	44-198
12/10 mm	44-199
1/4"	44-096









I.A.C. Komponenter AB
International Automation Components

P.O. Box 60, S-566 22 Habo • Phone: +46 (0)36 477 00 • Fax: +46 (0)36 477 15
E-mail: habo@iackomp.se • www.iackomp.se • Reg.No. 556461-2983

Rörkopplingar

Skärningskopplingar

- Fabrikat: Ermeto eller motsvarande • Syrafast 2343-316
- R (BSPP) - Europeisk cylindrisk gänga • KR (BSPT) - Europeisk konisk gänga
- Finns även i andra dimensioner och utföranden.

Rördim. x gänga	Typnr.	Artikelnummer
Rak koppling utv. gänga		R
	6 mm x 1/8"	GE 6-LR 1/8 SY 42-001
	6 mm x 1/4"	GE 6-LR 1/4 SY 42-002
	8 mm x 1/4"	GE 8-LR 1/4 SY 42-0022
	10 mm x 1/4"	GE 10-LR 1/4 SY 42-0024
	12 mm x 1/4"	GE 12-LR 1/4 SY 42-003
	12 mm x 3/8"	GE 12-LR 3/8 SY 42-004
	12 mm x 1/2"	GE 12-LR 1/2 SY 42-005
	12 mm x 3/4"	GE 12-LR 3/4 SY 42-006
	18 mm x 1/2"	GE 18-LR 1/2 SY 42-007
	20 mm x 3/4"	GE 20-SR 3/4 SY 42-0072
	30 mm x 1 1/2"	GE 30-SR 1 1/2 SY 42-0078
Rak koppling inv. gänga		R
	6 mm x 1/8"	GAI 6-LR 1/8 SY 42-008
	12 mm x 3/8"	GAI 12-LR 3/8 SY 42-009
	12 mm x 1/2"	GAI 12-LR 1/2 SY 42-010
	16 mm x 1/2"	GAI 16-SR 1/2 SY 42-0104
	18 mm x 1/2"	GAI 18-LR 1/2 SY 42-011
Vinkelkoppling utv. gänga		KR
	6 mm x 1/8"	WE 6-LR 1/8 SY 42-014
	6 mm x 1/4"	WE 6-LR 1/4 SY 42-015
	8 mm x 1/4"	WE 8-LR 1/4 SY 42-0152
	10 mm x 1/4"	WE 10-LR 1/4 SY 42-0154
	12 mm x 1/4"	WE 12-LR 1/4 SY 42-016
	12 mm x 3/8"	WE 12-LR 3/8 SY 42-017
	12 mm x 1/2"	WE 12-LR 1/2 SY 42-018
	16 mm x 1/2"	WE 16-SR 1/2 SY 42-0182
	18 mm x 1/2"	WE 18-LR 1/2 SY 42-019
Skarvkoppling rak		
	6 mm	G 6-L SY 42-020
	8 mm	G 8-L SY 42-0202
	10 mm	G 10-L SY 42-0204
	12 mm	G 12-L SY 42-021
	15 mm	G 15-L SY 42-0212
	18 mm	G 18-L SY 42-022
	30 mm	G 30-L SY 42-0228
Skarvkoppling vinkel		
	6 mm	W 6-L SY 42-023
	8 mm	W 8-L SY 42-0232
	12 mm	W 12-L SY 42-024
	16 mm	W 16-L SY 42-0243
	18 mm	W 18-L SY 42-025
	30 mm	W 30-L SY 42-0258
Skottgenomföring		
	15 mm	SV 15-L SY 42-0275



I.A.C. Komponenter AB

International Automation Components

P.O. Box 60, S-566 22 Habo • Phone: +46 (0)36 477 00 • Fax: +46 (0)36 477 15

E-mail: habo@iackomp.se • www.iackomp.se • Reg.No. 556461-2983

Rörkopplingar

Skärringskopplingar

- Fabrikat: Ermeto eller motsvarande • Syrafast 2343-316
- R (BSPP) - Europeisk cylindrisk gänga • KR (BSPT) - Europeisk konisk gänga
- Finns även i andra dimensioner och utföranden.



Rördim. x gänga	Typnr.	Artikelnummer
T-koppling		
6 mm	T 6-L SY	42-028
8 mm	T 8-L SY	42-0281
10 mm	T 10-L SY	42-0282
12 mm	T 12-L SY	42-029
15 mm	T 15-L SY	42-0292
16 mm	T 16-L SY	42-0293
18 mm	T 18-L SY	42-030
20 mm	T 20-L SY	42-0301
T-koppling utv. gänga		KR
6 mm x 1/8"	TE 6-LR 1/8 SY	42-031
12 mm x 3/8"	TE 12-LR 3/8 SY	42-032
16 mm x 1/2"	TE 16-SR 1/2 SY	42-0324
L-koppling utv. gänga		KR
15 mm x 1/2"	LE 15-LR 1/2 SY	42-0392
16 mm x 1/2"	LE 16-SR 1/2 SY	42-040
Mutter		
6 mm	M 6-L SY	42-033
12 mm	M 12-L SY	42-034
18 mm	M 18-L SY	42-035
Skärring		
6 mm	D 6-L SY	42-036
12 mm	D12-L SY	42-037



I.A.C. Komponenter AB
International Automation Components

P.O. Box 60, S-566 22 Habo • Phone: +46 (0)36 477 00 • Fax: +46 (0)36 477 15
E-mail: habo@iackomp.se • www.iackomp.se • Reg.No. 556461-2983



Certificate No 488/94

Rörkopplingar

Klämringskopplingar - tumdimension

- Fabrikat: Safelok • Syrafast stål 316 - 2343 • NPT - Amerikansk konisk rörgänga
- Finns även med BSPP eller BSPT-gänga



Rördim. x gänga	Typnr.	Artikelnummer
-----------------	--------	---------------

Rak anslutning utv. gänga		NPT
1/8" x 1/8"	2MC2	42-500
1/8" x 1/4"	2MC4	42-501
1/4" x 1/8"	4MC2	42-505
1/4" x 1/4"	4MC4	42-506
1/4" x 3/8"	4MC6	42-507
1/4" x 1/2"	4MC8	42-508
3/8" x 1/8"	6MC2	42-511
3/8" x 1/4"	6MC4	42-512
3/8" x 1/4" BSPP	6MC4-BSPP	42-5125
3/8" x 3/8"	6MC6	42-513
3/8" x 3/8" BSPP	6MC6-BSPP	42-5135
3/8" x 1/2"	6MC8	42-514
3/8" x 1/2" BSPP	6MC8-BSPP	42-5145
3/8" x 3/4"	6MC12	42-515
1/2" x 1/4"	8MC4	42-516
1/2" x 3/8"	8MC6	42-517
1/2" x 1/2"	8MC8	42-518
1/2" x 1/2" BSPP	8MC8-BSPP	42-5185
1/2" x 3/4"	8MC12	42-519
1/2" x 3/4" BSPP	8MC12-BSPP	42-5195
3/4" x 1/4"	12MC4	42-5197
3/4" x 1/2"	12MC8	42-520
3/4" x 3/4"	12MC12	42-521
1" x 3/4"	16MC12	42-522
1" x 1"	16MC16	42-523

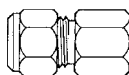

Rak anslutning inv. gänga		NPT
1/8" x 1/8"	2FC2	42-564
1/8" x 1/4"	2FC4	42-565
1/4" x 1/8"	4FC2	42-567
1/4" x 1/4"	4FC4	42-568
1/4" x 3/8"	4FC6	42-569
1/4" x 1/2"	4FC8	42-570
3/8" x 1/8"	6FC2	42-573
3/8" x 1/4"	6FC4	42-574
3/8" x 3/8"	6FC6	42-575
3/8" x 1/2"	6FC8	42-576
1/2" x 1/4"	8FC4	42-577
1/2" x 3/8"	8FC6	42-578
1/2" x 1/2"	8FC8	42-579
1/2" x 5/8"	8FC10	42-5795
1/2" x 3/4"	8FC12	42-580
3/4" x 1/4"	12FC4	42-5807
3/4" x 1/2"	12FC8	42-581
3/4" x 3/4"	12FC12	42-582
1" x 3/4"	16FC12	42-583
1" x 1"	16FC16	42-584



I.A.C. Komponenter AB

International Automation Components

P.O. Box 60, S-566 22 Habo • Phone: +46 (0)36 477 00 • Fax: +46 (0)36 477 15

E-mail: habo@iackomp.se • www.iackomp.se • Reg.No. 556461-2983



Certificate No 488/94

Rörkopplingar

Klämringskopplingar - tumdimension

- Fabrikat: Safelok • Syrafast stål 316 - 2343 • NPT - Amerikansk konisk rörgänga
- Finns även med BSPP eller BSPT-gänga

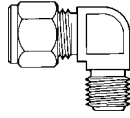

Rördim. x gänga Typnr. Artikelnummer

Vinkelanslutning utv. gänga

NPT

1/8" x 1/8"	2ME2	42-529
1/8" x 1/4"	2ME4	42-530
1/4" x 1/8"	4ME2	42-532
1/4" x 1/4"	4ME4	42-533
1/4" x 3/8"	4ME6	42-534
1/4" x 1/2"	4ME8	42-535
3/8" x 1/8"	6ME2	42-538
3/8" x 1/4"	6ME4	42-539
3/8" x 3/8"	6ME6	42-540
3/8" x 1/2"	6ME8	42-541
1/2" x 1/4"	8ME4	42-542
1/2" x 3/8"	8ME6	42-543
1/2" x 1/2"	8ME8	42-544
3/4" x 1/2"	12ME8	42-545
3/4" x 3/4"	12ME12	42-546
1" x 3/4"	16ME12	42-547
1" x 1"	16ME16	42-548

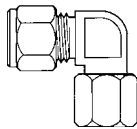

Vinkelanslutning inv. gänga

NPT

1/8" x 1/8"	2FE2	42-585
1/8" x 1/4"	2FE4	42-586
1/4" x 1/8"	4FE2	42-588
1/4" x 1/4"	4FE4	42-589
3/8" x 1/8"	6FE2	42-592
3/8" x 1/4"	6FE4	42-593
3/8" x 3/8"	6FE6	42-594
1/2" x 1/4"	8FE4	42-595
1/2" x 3/8"	8FE6	42-596
1/2" x 1/2"	8FE8	42-597
3/4" x 1/2"	12FE8	42-598
3/4" x 3/4"	12FE12	42-599

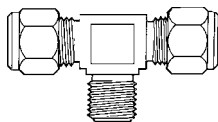

T-anslutning utv. gänga

NPT

1/8" x 1/8"	2TTM2	42-556
1/4" x 1/8"	4TTM2	42-558
1/4" x 1/4"	4TTM4	42-559
3/8" x 1/4"	6TTM4	42-561
1/2" x 3/8"	8TTM6	42-562
1/2" x 1/2"	8TTM8	42-563

T-anslutning inv. gänga

NPT

1/8" x 1/8"	2TTF2	42-600
1/4" x 1/8"	4TTF2	42-601
1/4" x 1/4"	4TTF4	42-602
3/8" x 1/4"	6TTF4	42-603
1/2" x 3/8"	8TTF6	42-604
1/2" x 1/2"	8TTF8	42-6042
3/4" x 3/4"	12TTF12	42-605



I.A.C. Komponenter AB

International Automation Components

P.O. Box 60, S-566 22 Habo • Phone: +46 (0)36 477 00 • Fax: +46 (0)36 477 15

E-mail: habo@iackomp.se • www.iackomp.se • Reg.No. 556461-2983



Certificate No 488/94

Rörkopplingar

Klämringskopplingar - tumdimension

- Fabrikat: Safelok • Syrafast stål 316 - 2343 • NPT - Amerikansk konisk rörgänga
- Finns även med BSPP eller BSPT-gänga

Rördim. x gänga	Typnr.	Artikelnummer
-----------------	--------	---------------

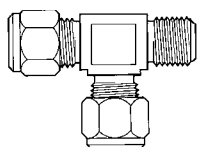

L-anslutning utv. gänga		NPT
-------------------------	--	-----

1/8" x 1/8"	2TMT2	42-549
1/4" x 1/8"	4TMT2	42-550
1/4" x 1/4"	4TMT4	42-551
3/8" x 1/4"	6TMT4	42-553
1/2" x 3/8"	8TMT6	42-554
1/2" x 1/2"	8TMT8	42-555

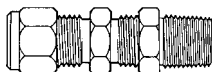

Skottgenomföring utv. gänga		NPT
-----------------------------	--	-----

1/8" x 1/8"	2MBH2	42-524
1/4" x 1/8"	4MBH2	42-525
1/4" x 1/4"	4MBH4	42-526
3/8" x 1/4"	6MBH4	42-527
1/2" x 1/2"	8MBH8	42-528

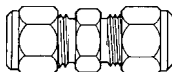

Skarvkoppling rak		
-------------------	--	--

1/8"	2U	42-606
1/4"	4U	42-608
3/8"	6U	42-610
1/2"	8U	42-611
3/4"	12U	42-612
1"	16U	42-613

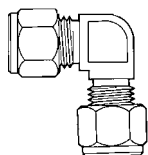

Skarvkoppling vinkel		
----------------------	--	--

1/8"	2ELU	42-630
1/4"	4ELU	42-632
3/8"	6ELU	42-634
1/2"	8ELU	42-635
3/4"	12ELU	42-636
1"	16ELU	42-637

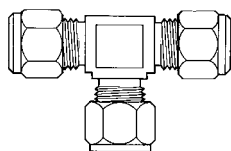

T-koppling		
------------	--	--

1/8"	2TTT	42-638
1/4"	4TTT	42-640
3/8"	6TTT	42-642
1/2"	8TTT	42-643
3/4"	12TTT	42-644
1"	16TTT	42-645

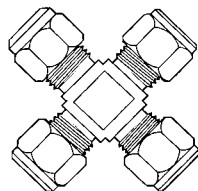

Korskoppling		
--------------	--	--

1/8"	2UC	42-646
1/4"	4UC	42-647
3/8"	6UC	42-648
1/2"	8UC	42-649
3/4"	10UC	42-6495



I.A.C. Komponenter AB

International Automation Components

P.O. Box 60, S-566 22 Habo • Phone: +46 (0)36 477 00 • Fax: +46 (0)36 477 15

E-mail: habo@iackomp.se • www.iackomp.se • Reg.No. 556461-2983





Certificate No 488/94

Rörkopplingar

Klämringskopplingar - tumdimension

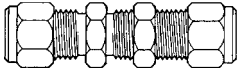
- Fabrikat: Safelok • Syrafast stål 316 - 2343 • NPT - Amerikansk konisk rörgänga
- Finns även med BSPP eller BSPT-gänga

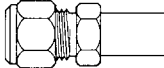
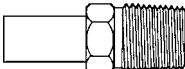
Rördimension	Typnr.	Artikelnummer
Skottgenomföring		
	1/8"	2BHU 42-623
	1/4"	4BHU 42-625
	3/8"	6BHU 42-627
	1/2"	8BHU 42-628
	3/4"	12BHU 42-629
Reduceringskoppling		
	1/4" x 1/8"	4RU2 42-615
	3/8" x 1/4"	6RU4 42-618
	1/2" x 1/4"	8RU4 42-620
	1/2" x 3/8"	8RU6 42-621
	3/4" x 1/2"	12RU8 42-622
	1" x 3/4"	16RU12 42-6225
Reduceringsadapter		
	1/8" x rör 1/4" YD	2RED4 42-651
	1/8" x rör 3/8" YD	2RED6 42-652
	1/4" x rör 1/8" YD	4RED2 42-654
	1/4" x rör 1/4" YD	4RED4 42-656
	1/4" x rör 3/8" YD	4RED6 42-658
	1/4" x rör 1/2" YD	4RED8 42-659
	3/8" x rör 1/4" YD	6RED4 42-662
	3/8" x rör 1/2" YD	6RED8 42-663
	3/8" x rör 3/4" YD	6RED12 42-664
	1/2" x rör 3/4" YD	8RED12 42-665
	1/2" x rör 1" YD	8RED16 42-666
Kopplingsadapter utv. gänga		BSPP
	Rör 1/4" YD x 1/4"	4ATPM4-BSPP 42-480
	Rör 3/8" YD x 1/4"	6ATPM4-BSPP 42-482
	Rör 1/2" YD x 1/2"	8ATPM8-BSPP 42-489



I.A.C. Komponenter AB

International Automation Components

P.O. Box 60, S-566 22 Habo • Phone: +46 (0)36 477 00 • Fax: +46 (0)36 477 15

E-mail: habo@iackomp.se • www.iackomp.se • Reg.No. 556461-2983



Certificate No 488/94

Rörkopplingar

Klämringskopplingar - tumdimension

- Fabrikat: Safelok • Syrafast stål 316 - 2343 • NPT - Amerikansk konisk rörgänga
- Finns även med BSPP eller BSPT-gänga

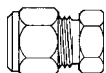

Rördimension	Typnr.	Artikelnummer
--------------	--------	---------------

Klämringsplugg

1/8"	2BE	42-667
1/4"	4BE	42-669
3/8"	6BE	42-671
1/2"	8BE	42-672
3/4"	12BE	42-673
1"	16BE	42-674



Kopplingsplugg

1/8"	BP2	42-675
1/4"	BP4	42-677
3/8"	BP6	42-679
1/2"	BP8	42-680
3/4"	BP12	42-681
1"	BP16	42-682



Mutter

1/8"	2N	42-689
1/4"	4N	42-691
3/8"	6N	42-693
1/2"	8N	42-694
3/4"	12N	42-695
1"	16N	42-696



Klämringar bakre och främre (konor)

1/8"	2 RC+FC	42-683
1/4"	4 RC+FC	42-684
3/8"	6 RC+FC	42-685
1/2"	8 RC+FC	42-686
3/4"	12 RC+FC	42-687
1"	16 RC+FC	42-688



I.A.C. Komponenter AB

International Automation Components

P.O. Box 60, S-566 22 Habo • Phone: +46 (0)36 477 00 • Fax: +46 (0)36 477 15

E-mail: habo@iackomp.se • www.iackomp.se • Reg.No. 556461-2983

Gängrördelar – Rostfritt

- Syrafast stål 316 - 2343 • Utv. gänga KR (BSPT) - Europeisk konisk rörgänga
- Inv. gänga R (BSPP) - Europeisk cylindrisk rörgänga • NPT - Amerikansk konisk rörgänga • Finns även i andra dimensioner och utföranden.



Rörgänga	Typnr.	Artikelnummer	
Muff inv. gänga		BSPP	NPT

1/8"	R201-DN6	41-073	41-695
1/4"	R201-DN8	41-074	41-696
3/8"	R201-DN10	41-075	41-697
1/2"	R201-DN15	41-076	41-698
3/4"	R201-DN20	41-077	41-699
1"	R201-DN25	41-078	41-700



Sexkantsnippel utv. gänga		BSPT	NPT
----------------------------------	--	-------------	------------

1/8"	R207-DN6	41-061	41-600
1/4"	R207-DN8	41-062	41-601
3/8"	R207-DN10	41-063	41-602
1/2"	R207-DN15	41-064	41-603
3/4"	R207-DN20	41-065	41-604
1"	R207-DN25	41-066	41-605



Svetsnippel utv. gänga		BSPT	NPT
-------------------------------	--	-------------	------------

1/8"	R208-DN6	41-067	41-715
1/4"	R208-DN8	41-068	41-716
3/8"	R208-DN10	41-069	41-717
1/2"	R208-DN15	41-070	41-718
3/4"	R208-DN20	41-071	41-719
1"	R208-DN25	41-072	41-720



Nippelrör utv. gänga		BSPT	NPT
-----------------------------	--	-------------	------------

1/8" L=40mm	R210-DN6	41-079	41-637
1/4" L=40mm	R210-DN8	41-080	41-638
3/8" L=40mm	R210-DN10	41-081	41-639
1/2" L=60mm	R210-DN15	41-082	41-640
3/4" L=60mm	R210-DN20	41-0821	41-641
1" L=60mm	R210-DN25	41-0822	41-642



T-rör inv. gänga		BSPP	NPT
-------------------------	--	-------------	------------

1/8"	R221-DN6	41-046	41-645
1/4"	R221-DN8	41-047	41-646
3/8"	R221-DN10	41-048	41-647
1/2"	R221-DN15	41-049	41-648
3/4"	R221-DN20	41-050	41-649
1"	R221-DN25	41-051	41-650



Vinkelrör inv. gänga		BSPP	NPT
-----------------------------	--	-------------	------------

1/8"	R222-DN6	41-040	41-653
1/4"	R222-DN8	41-041	41-654
3/8"	R222-DN10	41-042	41-655
1/2"	R222-DN15	41-043	41-656
3/4"	R222-DN20	41-044	41-657
1"	R222-DN25	41-045	41-658



Propp sexkantshuvud utv. gänga		BSPP	NPT
---------------------------------------	--	-------------	------------

1/8"	R236-DN6	41-034	41-618
1/4"	R236-DN8	41-035	41-619
3/8"	R236-DN10	41-036	41-620
1/2"	R236-DN15	41-037	41-621
3/4"	R236-DN20	41-038	41-622
1"	R236-DN25	41-039	41-623



I.A.C. Komponenter AB

International Automation Components

P.O. Box 60, S-566 22 Habo • Phone: +46 (0)36 477 00 • Fax: +46 (0)36 477 15

E-mail: habo@iackomp.se • www.iackomp.se • Reg.No. 556461-2983

Gängrördelar – Rostfritt

- Syrafast stål 316 - 2343 • Utv. gänga KR (BSPT) - Europeisk konisk rörgänga
- Inv. gänga R (BSPP) - Europeisk cylindrisk rörgänga • NPT - Amerikansk konisk rörgänga • Finns även i andra dimensioner och utföranden.



Rörgänga	Typnr.	Artikelnummer	
Propp utan ansats utv. gänga		BSPT	NPT

1/8"	R238-DN6	41-001	41-730
1/4"	R238-DN8	41-002	41-731
3/8"	R238-DN10	41-003	41-732
1/2"	R238-DN15	41-004	41-733
3/4"	R238-DN20	41-005	41-734
1"	R238-DN25	41-006	41-735



Förminskningsmuff inv. gänga		BSPP	NPT
-------------------------------------	--	-------------	------------

1/4" x 1/8"	R202-DN 8 x 6	41-026	41-705
3/8" x 1/4"	R202-DN10 x 8	41-027	41-706
1/2" x 1/4"	R202-DN15 x 8	41-028	41-707
1/2" x 3/8"	R202-DN15 x 10	41-029	41-708
3/4" x 3/8"	R202-DN20 x 10	41-030	41-709
3/4" x 1/2"	R202-DN20 x 15	41-031	41-710
1" x 1/2"	R202-DN25 x 15	41-032	41-711
1" x 3/4"	R202-DN25 x 20	41-033	41-712



Förminskningsnippel sexkant utv. gänga		BSPT	NPT
---	--	-------------	------------

1/4" x 1/8"	R209-DN 8 x 6	41-013	41-608
3/8" x 1/8"	R209-DN10 x 6	41-014	41-6085
3/8" x 1/4"	R209-DN10 x 8	41-015	41-609
1/2" x 1/8"	R209-DN15 x 6	41-016	41-6095
1/2" x 1/4"	R209-DN15 x 8	41-017	41-610
1/2" x 3/8"	R209-DN15 x 10	41-018	41-611
3/4" x 1/4"	R209-DN20 x 8	41-019	41-6115
3/4" x 3/8"	R209-DN20 x 10	41-020	41-612
3/4" x 1/2"	R209-DN20 x 15	41-021	41-613
1" x 3/8"	R209-DN25 x 10	41-023	41-6135
1" x 1/2"	R209-DN25 x 15	41-024	41-614
1" x 3/4"	R209-DN25 x 20	41-025	41-615



Bussning sexkant utv. x inv. gänga		BSP	NPT
---	--	------------	------------

1/4" x 1/8"	R211-DN 8 x 6	41-083	41-626
3/8" x 1/8"	R211-DN10 x 6	41-084	41-6265
3/8" x 1/4"	R211-DN10 x 8	41-085	41-627
1/2" x 1/8"	R211-DN15 x 6	41-086	41-628
1/2" x 1/4"	R211-DN15 x 8	41-087	41-629
1/2" x 3/8"	R211-DN15 x 10	41-088	41-630
3/4" x 1/4"	R211-DN20 x 8	41-089	41-6305
3/4" x 3/8"	R211-DN20 x 10	41-090	41-631
3/4" x 1/2"	R211-DN20 x 15	41-091	41-632
1" x 3/8"	R211-DN25 x 10	41-093	41-6325
1" x 1/2"	R211-DN25 x 15	41-094	41-633
1" x 3/4"	R211-DN25 x 20	41-095	41-634



Huv sexkant inv. gänga		BSPP	NPT
-------------------------------	--	-------------	------------

1/8"	R231-DN6	41-096	41-738
1/4"	R231-DN8	41-097	41-739
3/8"	R231-DN10	41-098	41-740
1/2"	R231-DN15	41-099	41-741
3/4"	R231-DN20	41-100	41-742
1"	R231-DN25	41-101	41-743



I.A.C. Komponenter AB





International Automation Components

P.O. Box 60, S-566 22 Habo • Phone: +46 (0)36 477 00 • Fax: +46 (0)36 477 15

E-mail: habo@iackomp.se • www.iackomp.se • Reg.No. 556461-2983

Gängrördelar – Rostfritt

- Syrafast stål 316 - 2343 • Utv. gänga KR (BSPT) - Europeisk konisk rörgänga
- Inv. gänga R (BSPP) - Europeisk cylindrisk rörgänga • NPT - Amerikansk konisk rörgänga • Finns även i andra dimensioner och utföranden.

Rörgänga	Typnr.	Artikelnummer		
Huv rund inv. gänga		BSPP	NPT	
	1/8"	R232-DN6	41-007	-
	1/4"	R232-DN8	41-008	-
	3/8"	R232-DN10	41-009	-
	1/2"	R232-DN15	41-010	-
	3/4"	R232-DN20	41-011	-
	1"	R232-DN25	41-012	-
Svetsmuff inv. gänga		BSPP	NPT	
	1/8"		41-102	41-723
	1/4"		41-103	41-724
	3/8"		41-104	41-725
	1/2"		41-105	41-726
	3/4"		41-106	41-727
	1"		41-107	41-728
Kontramutter inv. gänga		BSPP	NPT	
	1/8"		41-151	-
	1/4"		41-152	-
	3/8"		41-153	-
	1/2"		41-154	-
	3/4"		41-155	-
	1"		41-156	-
Sexkantsnippel utv. gänga				
	1/8" NPTxBSPP			41-301
	1/4" NPTxBSPP			41-302
	3/8" NPTxBSPP			41-303
	1/2" NPTxBSPP			41-304
	3/4" NPTxBSPP			41-305

Översättning mellan dimension tum och DN			
Dimension		Diametermått ca.	
Tum	DN	Utv.gänga	Inv.gänga
1/8"	DN06	10 mm	8 mm
1/4"	DN08	13 mm	11 mm
3/8"	DN10	17 mm	14 mm
1/2"	DN15	21 mm	18 mm
3/4"	DN20	27 mm	24 mm
1"	DN25	33 mm	30 mm



I.A.C. Komponenter AB

International Automation Components

P.O. Box 60, S-566 22 Habo • Phone: +46 (0)36 477 00 • Fax: +46 (0)36 477 15

E-mail: habo@iackomp.se • www.iackomp.se • Reg.No. 556461-2983

Gängrördelar – Förkromad mässing

- Utv. gänga KR (BSPT) - Europeisk konisk rörgänga
- Inv. gänga R (BSPP) - Europeisk cylindrisk rörgänga
- Finns även i andra dimensioner och utföranden.



Rörgänga

Artikelnummer

Muff sexkant inv. gänga

BSPP

1/8"	40-231
1/4"	40-232
3/8"	40-233
1/2"	40-234



Sexkantsnippel utv. gänga

BSPT

1/8"	40-201
1/4"	40-202
3/8"	40-203
1/2"	40-204



Förminskningsnippel utv. gänga

BSPT

1/4" x 1/8"	40-211
3/8" x 1/8"	40-212
3/8" x 1/4"	40-213
1/2" x 1/4"	40-214
1/2" x 3/8"	40-215



Bussning sexkant utv. x inv. gänga

BSP

1/4" x 1/8" o-ring	40-220
1/4" x 1/8"	40-221
3/8" x 1/8"	40-222
3/8" x 1/4"	40-223
1/2" x 1/8"	40-224
1/2" x 1/4"	40-225
1/2" x 3/8"	40-226



Förminskningsmuff inv. gänga

BSPP

1/4" x 1/8"	40-241
3/8" x 1/8"	40-242
3/8" x 1/4"	40-243
1/2" x 1/8"	40-244
1/2" x 1/4"	40-245
1/2" x 3/8"	40-246



Propp sexkant utv. gänga

BSPP

M5	40-250
1/8"	40-251
1/4"	40-252
3/8"	40-253
1/2"	40-254



Huv sexkant inv. gänga

BSPP

1/8"	40-256
1/4"	40-257
3/8"	40-258
1/2"	40-259



I.A.C. Komponenter AB

International Automation Components

P.O. Box 60, S-566 22 Habo • Phone: +46 (0)36 477 00 • Fax: +46 (0)36 477 15

E-mail: habo@iackomp.se • www.iackomp.se • Reg.No. 556461-2983

Gängrördelar – Förkromad mässing

- Utv. gänga KR (BSPT) - Europeisk konisk rörgänga
- Inv. gänga R (BSPP) - Europeisk cylindrisk rörgänga
- Finns även i andra dimensioner och utföranden.



Rörgänga	Artikelnummer
T-rör inv. gänga	BSPP
1/8"	40-271
1/4"	40-272
3/8"	40-273
1/2"	40-274
T-anslutning inv. x utv. gänga	BSP
1/8"	40-281
1/4"	40-282
3/8"	40-283
1/2"	40-284
Vinkelrör inv. gänga	BSPP
1/8"	40-261
1/4"	40-262
3/8"	40-263
1/2"	40-264
Vinkelanslutning inv. x utv. gänga	BSP
1/8"	40-266
1/4"	40-267
3/8"	40-268
1/2"	40-269
L-anslutning inv. x utv. gänga	BSP
1/8"	40-286
1/4"	40-287
3/8"	40-288
1/2"	40-289
Slangnippel utv. gänga	BSPP
7 mm x 1/8"	40-291
7 mm x 1/4"	40-292
9 mm x 1/4"	40-294
9 mm x 3/8"	40-295
12 mm x 1/4"	40-296
12 mm x 3/8"	40-297
12 mm x 1/2"	40-298
Distansrör inv. x utv. gänga	BSPP
1/8" L=16mm	40-301
1/8" L=36mm	40-302
1/8" L=45mm	40-303
1/4" L=27mm	40-304
1/4" L=43mm	40-305
Propp insex	BSPP
1/8"	40-310
1/4"	40-311
3/8"	40-312
1/2"	40-313



Gängrördelar – Mässing

- Utv. gänga KR (BSPT) - Europeisk konisk rörgänga
- Inv. gänga R (BSPP) - Europeisk cylindrisk rörgänga
- Finns även i andra dimensioner och utföranden.



Rörgänga	Artikelnummer	
Muff inv. gänga	BSPP	
1/8"	G06	40-092
1/4"	G08	40-090
3/8"	G10	40-091
1/2"	G15	40-089
Sexkantsnippel utv. gänga	BSPT	
1/8"	G06	40-070
1/4"	G08	40-071
3/8"	G10	40-072
1/2"	G15	40-073
Förminskningsnippel utv. gänga	BSPT	
1/4" x 1/8"	G08 x G06	40-013
3/8" x 1/8"	G10 x G06	40-014
3/8" x 1/4"	G10 x G08	40-017
1/2" x 1/8"	G15 x G06	40-018
1/2" x 1/4"	G15 x G08	40-016
1/2" x 3/8"	G15 x G10	40-015
3/4" x 1/2"	G20 x G15	40-021
Nippelrör utv. gänga (helgängad)	BSPP	
1/4"	G08	40-105
3/8"	G10	40-106
1/2"	G15	40-107
Bussning sexkant utv. x inv. gänga	BSP	
1/4" x 1/8"	G08xG06	40-083
3/8" x 1/8"	G10xG06	40-081
3/8" x 1/4"	G10xG08	40-085
1/2" x 1/8"	G15xG06	40-086
1/2" x 1/4"	G15xG08	40-087
1/2" x 3/8"	G15xG10	40-088
3/4" x 1/2"	G20xG15	40-082
T-stycke inv. gäng	BSPP	
1/8"	G06	40-100
1/4"	G08	40-101
3/8"	G10	40-102
1/2"	G15	40-103
Vinkel inv. gänga	BSPP	
1/8"	G06	40-095
1/4"	G08	40-096
3/8"	G10	40-097
1/2"	G15	40-098
Propp utv. gänga (med ansats)	BSPP	
1/8"	G06	40-004
1/4"	G08	40-006
3/8"	G10	40-010
1/2"	G15	40-012



Impuls-, analys- och skyddsror

- Rör levereras i standardlängder om 6 m där inget annat anges.
- Rör upp till dim. 16mm har oftast tolerans D4/T3.
- Finns även i andra dimensioner och utföranden.
- Rostfritt 2333 - 304, Syrafast 2343 - 316



Rördimension	Artikelnummer
Svetsat-kalibrerat	Rostfritt
16 x 1.0 mm	33-004
18 x 1.0 mm	33-001
18 x 1.5 mm	33-005
20 x 1.0 mm	33-008
20 x 1.5 mm	33-006
22 x 1.5 mm	33-007
25 x 1.0 mm	33-009
25 x 1.5 mm	33-002
28 x 1.5 mm	33-003
30 x 1.5 mm	33-010
32 x 1.2 mm	33-012
32 x 1.5 mm	33-013
38 x 1.5 mm	33-011
53 x 1.5 mm	33-015
54 x 2.0 mm	33-016
60,3 x 2.0 mm	33-018
Svetsat-kalibrerat	Syrafast
6 x 0.5 mm slinga (ca 220 m)	31-017
6 x 1.0 mm	31-001
8 x 1.0 mm	31-002
10 x 1.0 mm	31-003
12 x 1.0 mm	31-004
12 x 1.5 mm	31-020
14 x 1.0 mm	31-005
15 x 1.0 mm	31-0055
15 x 1.5 mm	31-008
16 x 1.0 mm	31-006
18 x 1.0 mm	31-007
18 x 1.5 mm	31-009
20 x 1.5 mm	31-010
25 x 1.5 mm	31-011
28 x 1.5 mm	31-012
38 x 1.6 mm	31-013
1/4" 13.5 x 2.3 mm	31-100
3/8" 17.2 x 2.3 mm	31-101
1/2" 21.3 x 2.6 mm	31-102
3/4" 26.9 x 2.6 mm	31-103
1" 33.7 x 3.2 mm	31-104
Sömlösa fallande 5-7 m	Syrafast
6 x 1.0 mm	32-001
8 x 1.0 mm	32-006
10 x 1.0 mm	32-002
12 x 1.0 mm	32-003
12 x 1.5 mm	32-004
12 x 2.0 mm	32-012
14 x 2.0 mm	32-014
15 x 1.5 mm	32-007
16 x 2.0 mm	32-005
18 x 1.5 mm	32-009
18 x 2.0 mm	32-018
20 x 2.0 mm	32-020
22 x 2.0 mm	32-022



I.A.C. Komponenter AB
International Automation Components

P.O. Box 60, S-566 22 Habo • Phone: +46 (0)36 477 00 • Fax: +46 (0)36 477 15
E-mail: habo@iackomp.se • www.iackomp.se • Reg.No. 556461-2983

Impuls-, analys- och skyddsror

- Rör levereras i standardlängder om 6 m där inget annat anges.
- Rör upp till dim. 16mm har oftast tolerans D4/T3.
- Finns även i andra dimensioner och utföranden.
- Aluminium AW 6060 T6



Rördimension	Artikelnummer
Sömlösa fallande 5-7 m	Syrafast
1/8" 3,18 x 0.71 mm	32-051
1/4" 6.35 x 0.89 mm	32-053
3/8" 9.53 x 1.65 mm	32-055
1/2" 12.7 x 1.24 mm	32-057
Runt rör EN AW-6060 T6	Aluminium
18 x 1.0 mm	36-001
18 x 1.5 mm	36-002
20 x 1.0 mm	36-004
20 x 1.5 mm	36-005
22 x 1.5 mm	36-007
25 x 1.5 mm	36-009
28 x 1.5 mm	36-010
30 x 2.0 mm	36-012
32 x 1.2 mm	36-014
32 x 1.5 mm	36-016
40 x 1.5 mm	36-020
50 x 1.5 mm	36-025



Fyrkantör och fästjärn

- Fyrkantör levereras i standardlängder om 6 m.
- Platt- och vinkeljärn levereras i fallande längder 4-6 m.
- Rostfritt 2333 - 304, Syrafast 2343 - 316

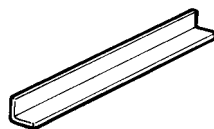
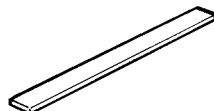
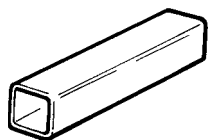

Dimension	Artikelnummer
Fyrkantör slipade	
	Rostfritt
20 x 20 x 1.5 mm	83-001
30 x 30 x 1.5 mm	83-003
40 x 40 x 2.0 mm	83-005
50 x 50 x 2.0 mm	83-007
Plattstål	
	Rostfritt
20 x 3 mm	83-072
20 x 4 mm	83-073
25 x 3 mm	83-075
25 x 5 mm	83-077
30 x 4 mm	83-079
30 x 5 mm	83-080
40 x 4 mm	83-082
40 x 5 mm	83-083
50 x 5 mm	83-086
Vinkelstål	
	Rostfritt
20 x 20 x 3 mm	83-120
30 x 30 x 3 mm	83-122
30 x 30 x 4 mm	83-123
40 x 40 x 4 mm	83-124
50 x 50 x 5 mm	83-125



I.A.C. Komponenter AB
International Automation Components

P.O. Box 60, S-566 22 Habo • Phone: +46 (0)36 477 00 • Fax: +46 (0)36 477 15
E-mail: habo@iackomp.se • www.iackomp.se • Reg.No. 556461-2983

Tillbehör till skydds- och fyrkantsrör

• Finns även i andra dimensioner och utföranden



Dimension	Artikelnummer
Ändmuff till rör rund utv.	Plast
20.4 mm/PG13 grå	38-114
22.5 mm/PG16 grå	38-115
37.0 mm/PG29 grå	38-123
Ändmuff till rör rund utv.	Plast
16 mm grå	38-146
18 mm grå	38-148
20 mm grå	38-150
22 mm grå	38-152
25 mm grå	38-155
28 mm grå	38-158
32 mm grå	38-162
40 mm grå	38-170
Ändhylsa till rör kragad	Rostfri
18 mm trumlad	38-202
28 mm trumlad	38-206
18 mm elpolerad	*
28 mm elpolerad	*
Skarvhylsa till rör	Rostfri
18 mm trumlad	38-212
28 mm trumlad	38-216
18 mm elpolerad	*
28 mm elpolerad	*
Ändpropp till fyrkantsrör	Plast
20 mm inv. svart	38-012
30 mm inv. svart	38-013
40 mm inv. svart	38-016
40 mm utv. svart	38-017
50 mm inv. svart	38-018
Skarvhylsa till rör	Aluminium
16 mm inv.	38-601
20 mm inv.	38-603
25 mm inv.	38-605
32 mm inv.	38-608
40 mm inv.	38-609
50 mm inv.	38-610
63 mm inv.	38-611

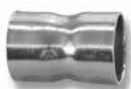

* mot order



I.A.C. Komponenter AB

International Automation Components

P.O. Box 60, S-566 22 Habo • Phone: +46 (0)36 477 00 • Fax: +46 (0)36 477 15

E-mail: habo@iackomp.se • www.iackomp.se • Reg.No. 556461-2983

Tillbehör till skydds- och fyrkantsrör

• Finns även i andra dimensioner och utföranden



Dimension	Artikelnummer
Muff till rör inv.	Syrafast
18 mm	38-302
22 mm	38-304
28 mm	38-306
Böj 90° till rör inv.	Syrafast
18 mm	38-322
22 mm	38-324
28 mm	38-326
Böj 45° till rör inv.	Syrafast
18 mm	38-342
22 mm	38-344
28 mm	38-346
Böj 90° utv	Syrafast
18 mm	38-362
22 mm	38-364
28 mm	38-366



I.A.C. Komponenter AB
International Automation Components

P.O. Box 60, S-566 22 Habo • Phone: +46 (0)36 477 00 • Fax: +46 (0)36 477 15
E-mail: habo@iackomp.se • www.iackomp.se • Reg.No. 556461-2983

Klammer och hållare

- Våra klammer och hållare är trumlade för att erhålla mjuka kanter och god ytfinish.
- Tillverkas i rostfritt – SIS 2333 och syrafast – SIS 2343 (A4).

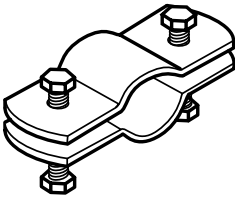
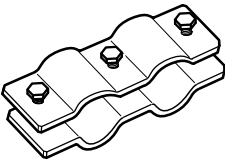
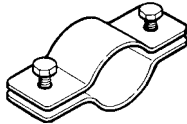
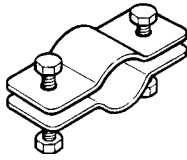

Dimension

Artikelnummer

Klammer tudelad exkl. bult			Rostfri	Syrafast
----------------------------	--	--	---------	----------

6 mm	(5-8 mm)	25 par/förp	81-003	81-103
12 mm	(9-14 mm)	"	81-001	81-101
18 mm	(15-22 mm)	"	81-005	81-105
28 mm	(23-30 mm)	"	81-010	81-110

Klammer gängad exkl. bult			Rostfri	Syrafast
---------------------------	--	--	---------	----------

6 mm	(5-8 mm)	25 par/förp	81-033	81-133
12 mm	(9-14 mm)	"	81-031	81-131
18 mm	(15-22 mm)	"	81-035	81-135
28 mm	(23-30 mm)	"	81-040	81-140

Endast gängade halvan,
12mm 81-032, 18mm 81-037, 28mm 81-042

Dubbelklammer gängad exkl. bult			Rostfri	Syrafast
---------------------------------	--	--	---------	----------

12 mm	(9-14 mm)	cc = 32 mm	81-021	*
18 mm	(15-22 mm)	cc = 42 mm	81-025	*
28 mm	(23-30 mm)	cc = 50 mm	81-030	*
18 mm + 28 mm	(15-22 mm + 23-30 mm)		81-028	*

Klammer tudelad exkl. bult			Rostfri	Syrafast
----------------------------	--	--	---------	----------

DK 31	(29-31 mm)		81-511	-
DK 35	(33-35 mm)		81-513	-
DK 39	(38-39 mm)		81-514	-
DK 43	(40-43 mm)		81-515	-
DK 45	(44-45 mm)		81-517	-
DK 49	(48-49 mm)		81-518	-
DK 56	(53-56 mm)		81-519	-
DK 61	(57-61 mm)		81-520	-
DK 64	(63-64 mm)		81-521	-
DK 71	(70-71 mm)		81-522	-
DK 77	(75-77 mm)		81-523	-
DK 84	(80-84 mm)		81-524	-
DK 90	(88-90 mm)		81-525	-
DK 104	(98-104 mm)		81-526	-
DK 110	(105-110 mm)		81-527	-

Finns i dimension upp till 410mm.

Bult och mutter för klammer		Rostfri	Syrafast
-----------------------------	--	---------	----------

M6 x 12 mm	200 st/förp	-	84-211
M6 x 16 mm	"	-	84-212
M6 x 20 mm	"	-	84-213
M6 x 25 mm	"	-	84-214
M10 x 40 mm	100 st/förp	-	84-237
Mutter M6	"	-	84-266
Mutter M10	50 st/förp	-	84-270

Rekommendation för bultstorlek till klammer

Klammer tudelad	6 mm	12 mm	18 mm	28 mm	
- Bult	M6 x 12	M6 x 16	M6 x 20	M6 x 25	
Klammer gängad		12 mm	18 mm	28 mm	
- Bult		M6 x 12	M6 x 16	M6 x 20	
Klammer tudelad	DK31	DK35	DK43	DK45	DK56
- Bult	M10 x 40	M10 x 40	M10 x 40	M10 x 40	M10 x 40



I.A.C. Komponenter AB

International Automation Components

P.O. Box 60, S-566 22 Habo • Phone: +46 (0)36 477 00 • Fax: +46 (0)36 477 15
E-mail: habo@iackomp.se • www.iackomp.se • Reg.No. 556461-2983

Klammer och hållare

- Våra klammer och hållare är trumlade för att erhålla mjuka kanter och god ytfinish.
- Tillverkas i rostfritt – SIS 2333 och syrafast – SIS 2343 (A4).

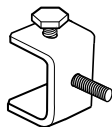
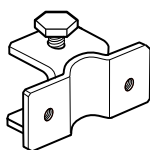
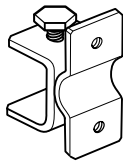
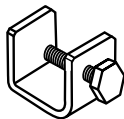
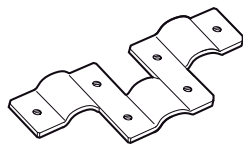
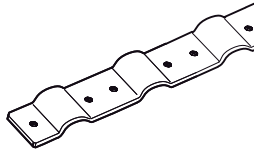
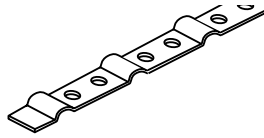

Dimension	Artikelnummer
Klammer löpmeter	Rostfri Syrafast
1-håls 12 mm för 28 st rör, cc = 32 mm	81-050 *
2-håls 12 mm för 17 st rör, cc = 55 mm	81-051 *
Längd ca 1 met	
Multiklammer	Rostfri Syrafast
12 mm gängad för 8 st rör, cc = 55 mm	81-056 *
18 mm gängad för 7 st rör, cc = 65 mm	81-057 *
28 mm gängad för 6 st rör, cc = 75 mm	81-058 *
Längd ca 0,5 met	
Trippelklammer	Rostfri Syrafast
12 mm gängad för 3 st rör, cc = 32 mm	81-066 *
18 mm gängad " cc = 42 mm	81-067 *
28 mm gängad " cc = 50 mm	81-068 *
Balkklammer inkl. bult	Rostfri Syrafast
20 mm M8 x 25mm 25 st/förp	81-352 *
25 mm M8 x 30mm "	81-350 *
35 mm M8 x 40mm "	81-354 *
Balkklammer med klammerhalva	Rostfri Syrafast
20 mm x 12mm gängad halva 10 st/förp	81-371 *
20 mm x 18mm gängad halva "	81-372 *
20 mm x 28mm gängad halva "	81-373 *
25 mm x 12mm gängad halva "	81-374 *
25 mm x 18mm gängad halva "	81-375 *
25 mm x 28mm gängad halva "	81-376 *
35 mm x 12mm gängad halva "	81-377 *
35 mm x 18mm gängad halva "	81-378 *
35 mm x 28mm gängad halva "	81-379 *
Klammer kan även svetsas efter eget önskemål.	
Balkklammer med klammerhalva 90°	Rostfri Syrafast
20 mm x 18mm gängad halva 10 st/förp	81-672 *
20 mm x 28mm gängad halva 10 st/förp	81-673 *
25 mm x 18mm gängad halva 10 st/förp	81-675 *
25 mm x 28mm gängad halva 10 st/förp	81-676 *
Balkklammer inkl. bult med M8 gängstång	Rostfri Syrafast
20 mm M8 gängstång L=20mm 25 st/förp	81-603 *
25 mm M8 gängstång L=20mm "	81-604 *
35 mm M8 gängstång L=20mm "	81-605 *
Sexkantsbult med spets	Syrafast
M8 x 25 mm	84-352
M8 x 30 mm	84-350
M8 x 40 mm	84-354

* mot order



I.A.C. Komponenter AB
International Automation Components

P.O. Box 60, S-566 22 Habo • Phone: +46 (0)36 477 00 • Fax: +46 (0)36 477 15
E-mail: habo@iackomp.se • www.iackomp.se • Reg.No. 556461-2983

Klammer och hållare

- Våra klamrar och hållare är trumlade för att erhålla mjuka kanter och god ytfinish.
- Tillverkas i rostfritt – SIS 2333 och syrafast – SIS 2343 (A4).

Dimension

Artikelnummer

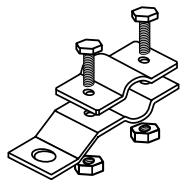

Väggållare exkl. klammerhalva & bult

Rostfri

Syrafast

6 mm ogängad (5-8 mm)	25 st/förp
12 mm ogängad (9-14 mm)	"
18 mm ogängad (15-22 mm)	"
28 mm ogängad (23-30 mm)	"

81-070
81-071
81-072
81-073

*
*
*
*

Fästhål Ø 9 mm

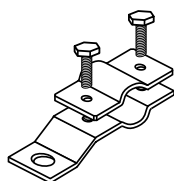

Väggållare exkl. klammerhalva & bult

Rostfri

Syrafast

6 mm gängad (5-8 mm)	25 st/förp
12 mm gängad (9-14 mm)	"
18 mm gängad (15-22 mm)	"
28 mm gängad (23-30 mm)	"

81-075
81-076
81-077
81-078

*
*
*
*

Fästhål Ø 9 mm

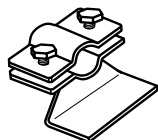

Väggfäste Utf.A exkl. klammerhalva & bult

Rostfri

Syrafast

18 mm ogängad halva	25 st/förp
28 mm ogängad halva	"
18 mm gängad halva	"
28 mm gängad halva	"

81-315
81-320
81-335
81-340

81-415
81-420
81-435
81-440

Förhöjd 35 mm

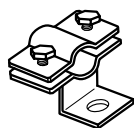

Väggfäste Utf.B exkl. klammerhalva & bult

Rostfri

Syrafast

12 mm ogängad halva	25 st/förp
18 mm ogängad halva	"
28 mm ogängad halva	"
12 mm gängad halva	"
18 mm gängad halva	"
28 mm gängad halva	"

81-361
81-362
81-363
81-366
81-367
81-368

*
*
*
*
*
*

Förhöjd 35 mm, Fästhål Ø 9 mm



Rörållare inkl. skruv

Rostfri

Syrafast

PK 07 (11-13 mm)	50 st/förp
PK 09 (14-16 mm)	"
PK 11 (17-19 mm)	"
PK 13,5 (19-21 mm)	"
PK 16 (21-23 mm)	"
PK 21 (24-29 mm)	"
PK 29 (30-38 mm)	25 st/förp
PK 36 (39-48 mm)	"
PK 42 (48-54 mm)	"
PK 48 (53-61 mm)	"

81-221
81-222
81-223
81-224
81-225
81-226
81-227
81-228
81-229
81-230

-
-
-
-
-
-
-
-
-
-

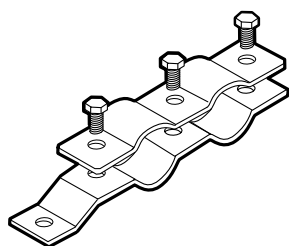

Väggållare dubbelklammer exkl. bult

Rostfri

Syrafast

12 mm (9-14 mm)	cc = 32 mm
18 mm (15-22 mm)	cc = 42 mm
28 mm (23-30 mm)	cc = 50 mm
18 mm + 28 mm (15-22 mm + 23-30 mm)	

81-341
81-342
81-343
81-344

*
*
*
*

* mot order



I.A.C. Komponenter AB

International Automation Components

P.O. Box 60, S-566 22 Habo • Phone: +46 (0)36 477 00 • Fax: +46 (0)36 477 15
E-mail: habo@iackomp.se • www.iackomp.se • Reg.No. 556461-2983

Klammer och hållare

- Våra hållare är trumlade för att erhålla mjuka kanter och god ytfinish.
- Tillverkas i rostfritt – SIS 2333 och syrafast – SIS 2343
- Rörhållare (PK) finns även i aluminium eller elgalv.

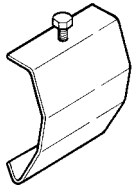

Dimension	Artikelnummer	
-----------	---------------	--

Stegfäste "KHZ" inkl. bult (M6 x 16)		Rostfri	Syrafast
L= 25 mm, 1 st bult	25 st/förp	81-302	81-402
L= 50 mm, 1 st bult	"	81-301	81-401
L=100 mm, 2 st bult	"	81-300	81-400

Passar även till Lolab-stegar.

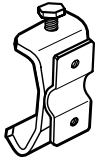

Stegfäste 25 mm med klammerhalva		Rostfri	Syrafast
12 mm gängad	25 st/förp	81-306	*
18 mm gängad	"	81-307	*
28 mm gängad	"	81-308	*

Passar även till Lolab-stegar.

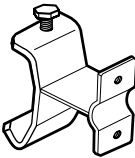

Stegfäste 25 mm med förhöjd klammerhalva		Rostfri	Syrafast
12 mm gängad förhöjd 25 mm	25 st/förp	81-310	*
18 mm gängad förhöjd 25 mm	"	81-311	*
28 mm gängad förhöjd 25 mm	"	81-312	*

Passar även till Lolab-stegar.

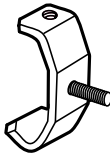

Stegfäste med M8 gängstång inkl. bult (M6 x 16)		Rostfri	Syrafast
L= 25 mm, M8 gängstång L=20mm		81-602	*

Passar även till Lolab-stegar.



Stegfäste "MP" inkl. bult (M6x16)		Rostfri	Syrafast
L= 25 mm, 1 st bult	25 st/förp	81-305	*
L= 50 mm, 1 st bult	"	81-304	*
L=100 mm, 2 st bult	"	81-303	*

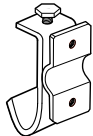

Stegfäste "MP" med klammerhalva		Rostfri	Syrafast
18 mm gängad		81-607	*
28 mm gängad		81-608	*

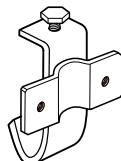

Stegfäste "MP" med klammerhalva 90°		Rostfri	Syrafast
18 mm gängad		81-617	*
28 mm gängad		81-618	*



Stegfäste "MEKA" inkl. bult (M6x16)		Rostfri	Syrafast
L= 25 mm, 1 st bult	25 st/förp	81-702	*
L= 50 mm, 1 st bult	"	81-701	*
L=100 mm, 2 st bult	"	81-702	*

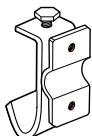

Stegfäste "MEKA" med klammerhalva		Rostfri	Syrafast
18 mm gängad		81-705	*
28 mm gängad		81-706	*

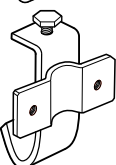

Stegfäste "MEKA" med klammerhalva 90°		Rostfri	Syrafast
18 mm gängad		81-709	*
28 mm gängad		81-710	*

* mot order



I.A.C. Komponenter AB

International Automation Components

P.O. Box 60, S-566 22 Habo • Phone: +46 (0)36 477 00 • Fax: +46 (0)36 477 15
E-mail: habo@iackomp.se • www.iackomp.se • Reg.No. 556461-2983

Klammer och hållare

- Våra hållare är trumlade för att erhålla mjuka kanter och god ytfinish.
- Tillverkas i rostfritt – SIS 2333 och syrafast – SIS 2343
- Rörhållare (PK) finns även i aluminium eller elgalv.

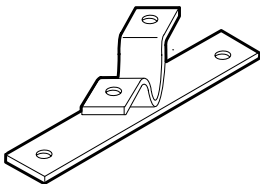
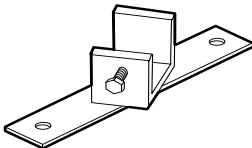
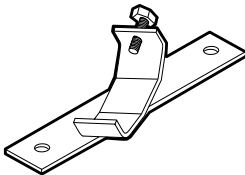
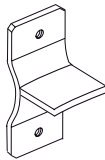
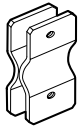
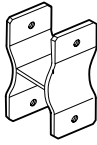

Dimension	Artikelnummer	
-----------	---------------	--

Parklammer distans 20 mm	Rostfri	Syrafast
12 mm ogängad + 12 mm gängad	81-382	*
18 mm ogängad + 18 mm gängad	81-385	*
28 mm ogängad + 28 mm gängad	81-389	*

Parklammer distans 20 mm	Rostfri	Syrafast
18 mm ogängad + 12 mm gängad	81-384	*
28 mm ogängad + 12 mm gängad	81-387	*
28 mm ogängad + 18 mm gängad	81-388	*

Parklammer	Rostfri	Syrafast
12 mm gängad	81-392	*
18 mm gängad	81-395	*
28 mm gängad + 18 mm gängad	81-398	*
28 mm gängad	81-399	*

Gängad klammer med distans 25mm	Rostfri	Syrafast
12 mm gängad	81-346	*
18 mm gängad	81-347	*
28 mm gängad	81-348	*

Dosfäste med stegfäste 25mm	Rostfri	Syrafast
25 mm stegfäste "KHZ"	81-322	*

Dosfäste med balkklammer	Rostfri	Syrafast
20 mm M8 x 25mm	81-323	*
25 mm M8 x 30mm	81-324	*
35 mm M8 x 40mm	81-325	*

Dosfäste med gängad klammer	Rostfri	Syrafast
12 mm gängad	81-326	*
18 mm gängad	81-327	*
28 mm gängad	81-328	*

* mot order



I.A.C. Komponenter AB

International Automation Components

P.O. Box 60, S-566 22 Habo • Phone: +46 (0)36 477 00 • Fax: +46 (0)36 477 15
E-mail: habo@iackomp.se • www.iackomp.se • Reg.No. 556461-2983

Klammer och hållare

- Våra hållare är trumlade för att erhålla mjuka kanter och god ytfinish.
- Tillverkas i rostfritt – SIS 2333 och syrafast – SIS 2343
- Rörhållare (PK) finns även i aluminium eller elgalv.

Dimension		Artikelnummer	
Svetshållare fästhål Ø 9 mm		Rostfri	Syrafast
25 mm x 35 mm	50 st/förp	81-082	81-182
25 mm x 40 mm	"	81-083	81-183
25 mm x 50 mm	"	81-080	81-180
25 mm x 80 mm	"	81-081	81-181
Fäste för dosa		Rostfri	Syrafast
20x110 mm fästhål Ø 6 mm		81-090	*
20x110 mm fästhål M5 gängad		81-0903	*
20x110 mm fästhål M6 gängad		81-0905	*
Plåt för skylt		Rostfri	Syrafast
20x100x1 mm hål Ø 3,5 mm		81-095	*
20x100x2 mm hål Ø 3,5 mm		81-094	*
Flänsfäste		Rostfri	Syrafast
40x250 mm fästhål Ø 21 mm		81-091	*
40x350 mm fästhål Ø 18 mm		81-092	*
Plåt		Rostfri	Syrafast
För dosa 90 x 90 x 2 mm (2 hål M4)		81-097	*
För dosa 90 x 90 x 2 mm (5 hål, nya dosan)		81-0975	*
För dosa 90 x 90 x 2 mm (4 hål M4)		81-096	*
Utan hål 100 x 100 x 2 mm		81-098	*
Buntband		Plast	
200 mm	svart	85-103	
200 mm med ögla	vit	85-108	
200 mm med ögla	svart	85-109	
19 x 19 ankare	vit	85-114	
29 x 29 ankare	vit	85-116	
Nyckelring för skylt		Rostfri	Syrafast
Ø 30 mm		-	85-155
Dosplåt "Malux" 25mm stegfäste		Rostfri	Syrafast
För dosa 99 x 81 x 2 mm (4 hål M4)		81-622	*
För dosa 99 x 81 x 2 mm 90° (4 hål M4)		81-623	*

* mot order



I.A.C. Komponenter AB
International Automation Components

P.O. Box 60, S-566 22 Habo • Phone: +46 (0)36 477 00 • Fax: +46 (0)36 477 15
E-mail: habo@iackomp.se • www.iackomp.se • Reg.No. 556461-2983

Hållare och kondenskärl

- Vi tillverkar efter ert behov. Har ni något önskemål, vänligen fråga oss.
- Tillverkas i rostfritt – SIS 2333, syrafast – SIS 2343 (A4) eller förzinkad plåt

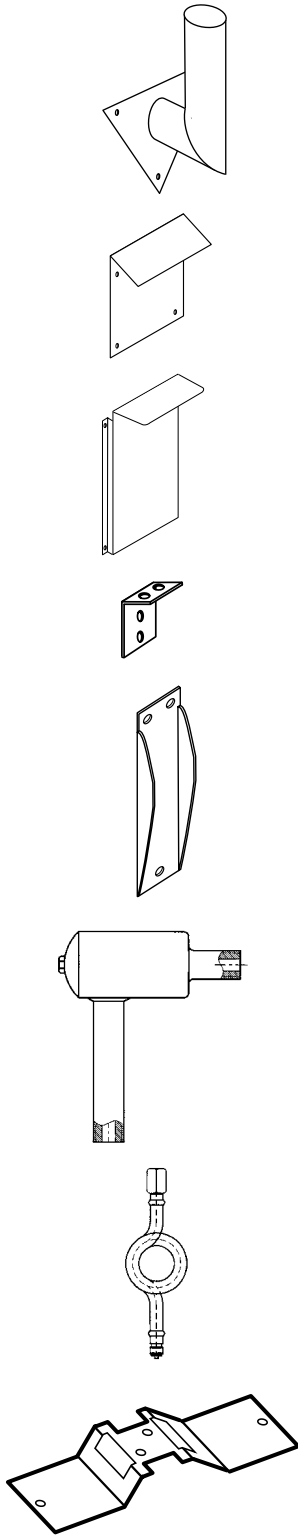

Dimension	Artikelnummer	
Hållare DP-cell	Rostfri	Syrafast
Rör Ø 53 mm	78-810	*
Plåt med tak	Rostfri	Syrafast
190 x 200 x 150 mm	78-861	*
250 x 250 x 150 mm	78-862	*
250 x 400 x 150 mm	78-863	*
Upphöjd plåt med tak	Rostfri	Syrafast
250 (300) x 400 x 150 mm	78-814	*
Fästvinkel för magnetventil	Rostfri	Syrafast
35 x 40 x 25 mm	78-823	*
Fäste för ventilblock klinger	Rostfri	Syrafast
64 x 150 mm	65-901	*
Kondenskärl PN100	Rostfri	Syrafast
1/2" R utv.	*	78-742
1/2" R utv. med plugg	*	78-743
Kan även erhållas i materialen:		
- SIS 1430		
- SIS 2333		
Med tryckklass PN 16 – 135		
Vattensäcksrör Rak PN100	Rostfri	Syrafast
1/2" R inv. x utv.	-	78-431
Skylthållare	Rostfri	Syrafast
30 x 110 mm	85-131	*

* mot order



I.A.C. Komponenter AB
International Automation Components

P.O. Box 60, S-566 22 Habo • Phone: +46 (0)36 477 00 • Fax: +46 (0)36 477 15
E-mail: habo@iackomp.se • www.iackomp.se • Reg.No. 556461-2983

Klammer och hållare

- PP-klammer går även att erhålla i polyamid och aluminium.
- Våra hållare är trumlade för att erhålla mjuka kanter och god ytfinish.
- Tillverkas i rostfritt – SIS 2333, syrafast – SIS 2343 (A4) på förfrågan.

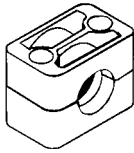

Dimension		Artikelnummer	
PP-klammer Plast		Grön	Blå
6 mm		82-001	82-051
8 mm		82-002	82-052
10 mm		82-003	82-053
12 mm		82-004	82-054
14 mm		82-0051	*
15 mm		82-0052	*
16 mm		82-0053	*
18 mm		82-006	82-056
20 mm		82-0071	82-0571
22 mm		82-0072	*
25 mm		82-0073	82-0573
28 mm		82-008	82-058
30 mm		82-0091	*
6 mm dubbel		82-011	82-061
8 mm dubbel		82-012	82-062
10 mm dubbel		82-013	82-063
12 mm dubbel		82-014	82-064
PP-klammer		Aluminium	
6 mm		82-031	
8 mm		82-032	
10 mm		82-033	
12 mm		82-034	
14 mm		82-0351	
15 mm		82-0352	
16 mm		82-0353	
18 mm		82-036	
20 mm		82-0371	
22 mm		82-0372	
25 mm		82-0373	
28 mm		82-038	
30 mm		82-0391	
Täckplatta		Rostfri	
12 mm	(6-12 mm) dubbel	82-141	
12 mm	(6-12 mm) enkel	82-144	
18 mm	(14-18 mm)	82-146	
25 mm	(20-25 mm)	82-147	
28 mm	(28-30 mm)	82-148	
42 mm	(35-42 mm)	82-149	
Svetsplatta även till C-skena 35-40 mm		Rostfri	
12 mm	(6-12 mm) även dubbel	82-104	
18 mm	(14-18 mm)	82-106	
25 mm	(20-25 mm)	82-107	
28 mm	(28-30 mm)	82-108	
42 mm	(35-42 mm)	82-109	
Skyltplatta		Rostfri	
12+28 mm	(6-12 mm + 28-30 mm)	82-128	
18 mm	(14-18 mm)	82-126	
25+42 mm	(20-25 mm + 35-42 mm)	82-127	

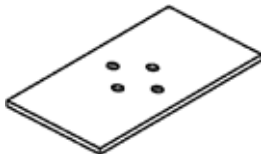
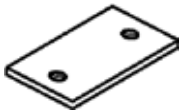
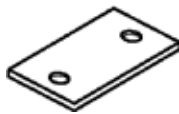

I.A.C. Komponenter AB
International Automation Components

P.O. Box 60, S-566 22 Habo • Phone: +46 (0)36 477 00 • Fax: +46 (0)36 477 15
E-mail: habo@iackomp.se • www.iackomp.se • Reg.No. 556461-2983

Klammer och hållare

- Våra hållare är trumlade för att erhålla mjuka kanter och god ytfinish.
- Tillverkas i rostfritt – SIS 2333 och syrafast – SIS 2343 (A4).

Dimension	Artikelnummer	
Montageplatta 1 fästhål Ø 9mm		
	Rostfri	
12 mm (6-12 mm) även dubbel	82-134	
18 mm (14-18 mm)	82-136	
25 mm (20-25 mm)	82-137	
28 mm (28-30 mm)	82-138	
42 mm (35-42 mm)	82-139	
Montageplatta 2 fästhål Ø 9mm		
	Rostfri	
12 mm (6-12 mm) även dubbel	82-114	
18 mm (14-18 mm)	82-116	
25 mm (20-25 mm)	82-117	
28 mm (28-30 mm)	82-118	
42 mm (35-42 mm)	82-119	
Väghållare PP-klammer		
	Rostfri	
12 mm (6-12 mm) även dubbel	82-154	
18 mm (14-18 mm)	82-156	
25 mm (20-25 mm)	82-157	
28 mm (28-30 mm)	82-158	
42 mm (35-42 mm)	82-159	
C-skena		
	Syrafast	
40 x 26 x 500 mm	82-171	
28 x 14 x 2000mm, TS-14	82-184	
Fästmutter		
	Syrafast	
M6 för C-skena TS-14	82-189	
Till C-skena 40 används svetsplatta för fastsättning av klammer.		
Insexskruv		
	Syrafast	
M6 x 25 mm	84-454	
M6 x 30 mm	84-455	
M6 x 35 mm	84-4555	
M6 x 40 mm	84-456	
Sexkantsbult		
	Syrafast	
M6 x 35 mm	84-2155	
M6 x 40 mm	84-216	
M6 x 45 mm	84-2165	
M6 x 50 mm	84-217	
Rörhållare polyamid		
	Plast	
KUPI2 (3-7 mm)	82-221	
KUPI2 (6-13 mm)	82-222	
KUPI2 (12-20 mm)	82-223	
KUPI2 (16-24 mm)	82-224	
KUPI2 (18-30 mm)	82-225	
KUPI2 (27-43 mm)	82-226	
Rekommendation för bultstorlek till plastklammer		
Klammer dimension	Bult & Skruv med täckplatta	Insex & Skruv utan täckplatta
6-12 mm	M6 x 35	M6 x 25
14-18 mm	M6 x 40	M6 x 30
20-25 mm	M6 x 45	M6 x 35
28-30 mm	M6 x 50	M6 x 40









Pneumatisk kabel & slang

Instrumentrör och flerledarkabel

- Fabrikat: Osnaline, där inget annat anges • Flamsäker pvc-mantel standard, kan även levereras med flamsäker halogenfri LDPE-mantel.
- Singelslang levereras i kartonger om 250 m (6 mm), 100 m (8 mm), mantlad i 250m.
- Flerledarkabel levereras på trummor om ca 500 m.

Rördimension	Typnr.	Artikelnummer
Singelslang polyeten - LDPE halogenfri		
	6 x 1.0 mm blå	701 21-001
	6 x 1.0 mm röd	701 21-002
	6 x 1.0 mm svart	701 21-003
	6 x 1.0 mm grön	701 21-004
	6 x 1.0 mm gul	701 21-005
	6 x 1.0 mm vit	701 21-0065
	8 x 1.0 mm svart	701 21-009
	1/4" x 0.040" svart	701 21-007
	3/8" x 0.062" svart	701 21-008
Singelslang polyamid - PA halogenfri		
	4/2.7 mm blå	100 m/förp 21-235
	4/2.7 mm vit	" 21-236
	4/2.7 mm svart	" 21-237
	6/4.2 mm blå	" 21-238
	6/4.2 mm vit	" 21-239
	6/4.2 mm svart	" 21-240
	8/6 mm blå	50 m/förp 21-241
	8/6 mm vit	" 21-242
	8/6 mm svart	" 21-243
	10/8 mm blå	" 21-244
	10/8 mm vit	" 21-245
	10/8 mm svart	" 21-246
	12/10 mm blå	50 m/förp 21-247
	12/10 mm vit	" 21-248
	12/10 mm svart	" 21-249
Singelslang polyuretan - PUR halogenfri		
	4/2.2 mm blå	100 m/förp 21-251
	4/2.2 mm vit	" 21-252
	6/3.9 mm blå	" 21-253
	6/3.9 mm vit	" 21-254
	6/3.9 mm svart	" 21-2545
	8/5.7 mm blå	50 m/förp 21-255
	8/5.7 mm vit	" 21-256
	10/7.5 mm blå	" 21-257
	10/7.5 mm vit	" 21-258
	12/9 mm blå	" 21-259
	12/9 mm vit	" 21-260
Singelslang teflon - PTFE		
	6 x 1.0 mm vit	100 m/förp 21-280
	8 x 1.0 mm vit	" 21-281
Singelslang polyvinylklorid - PV		
	6/4 mm blå	100 m/förp 21-271
	8/6 mm blå	50 m/förp 21-273
	10/8 mm blå	" 21-275
	12/10 mm blå	" 21-277



I.A.C. Komponenter AB

International Automation Components

P.O. Box 60, S-566 22 Habo • Phone: +46 (0)36 477 00 • Fax: +46 (0)36 477 15
E-mail: habo@iackomp.se • www.iackomp.se • Reg.No. 556461-2983



Pneumatisk kabel & slang

Instrumentrör och flerledarkabel

- Fabrikat: Osnaline, där inget annat anges • Flamsäker pvc-mantel standard, kan även levereras med flamsäker halogenfri LDPE-mantel.
- Singelslang levereras i kartonger om 250 m (6 mm), 100 m (8 mm), mantlad i 250m.
- Flerledarkabel levereras på trummor om ca 500 m.



Rördimension	Typnr.	Artikelnummer
Singelslang PAUR		
4/2.5 mm blå	100 m/förp	21-2911
4/2.5 mm vit	"	21-2912
4/2.5 mm svart	"	21-2913
4/2.5 mm gul	"	21-2914
4/2.5 mm grå	"	21-2915
4/2.5 mm röd	"	21-2916
4/2.5 mm grön	"	21-2917
6/4 mm blå	100 m/förp	21-2921
6/4 mm vit	"	21-2922
6/4 mm svart	"	21-2923
6/4 mm gul	"	21-2924
6/4 mm grå	"	21-2925
6/4 mm röd	"	21-2926
6/4 mm grön	"	21-2927
8/6 mm blå	100 m/förp	21-2931
8/6 mm vit	"	21-2932
8/6 mm svart	"	21-2933
8/6 mm gul	"	21-2934
8/6 mm grå	"	21-2935
8/6 mm röd	"	21-2936
8/6 mm grön	"	21-2937
10/8 mm blå	"	21-2941
10/8 mm vit	"	21-2942
10/8 mm svart	"	21-2943
10/8 mm gul	"	21-2944
12/9 mm blå	"	21-2951
12/9 mm vit	"	21-2952
12/9 mm svart	"	21-2953
12/9 mm gul	"	21-2954



Singelslang polyeten/pvc-mantel		
6 x 1.0 mm blå	7010	21-082
6 x 1.0 mm svart	7010	21-083
8 x 1.0 mm blå	7010	21-084
8 x 1.0 mm svart	7010	21-085
10 x 1.0 mm blå	7010	21-086
10 x 1.0 mm svart	7010	21-087
12 x 1.0 mm blå	7010	21-088
12 x 1.0 mm svart	7010	21-089



Singelslang polyamid/LDPE-mantel halogenfri		
6 x 1.0 mm grön		21-571
6 x 1.0 mm blå		21-572
6 x 1.0 mm svart		21-573
8 x 1.0 mm blå		21-574
8 x 1.0 mm svart		21-575
10 x 1.0 mm blå		21-576
10 x 1.0 mm svart		21-577
12 x 1.0 mm svart		21-579



I.A.C. Komponenter AB

International Automation Components

P.O. Box 60, S-566 22 Habo • Phone: +46 (0)36 477 00 • Fax: +46 (0)36 477 15
E-mail: habo@iackomp.se • www.iackomp.se • Reg.No. 556461-2983



Pneumatisk kabel & slang

Instrumentrör och flerledarkabel

- Fabrikat: Osnaline, där inget annat anges • Flamsäker pvc-mantel standard, kan även levereras med flamsäker halogenfri LDPE-mantel.
- Singelslang levereras i kartonger om 250 m (6 mm), 100 m (8 mm), mantlad i 250m.
- Flerledarkabel levereras på trummor om ca 500 m.

Rördimension

Artikelnummer

Enkelrör koppar/pvc-mantel

6 x 1.0 mm svart	7050	21-071
8 x 1.0 mm svart	7050	21-072
10 x 1.0 mm svart	7050	21-073
12 x 1.0 mm svart	7050	21-074
1/4" x 0.036" svart	7050	21-075



Singelslang "Dekabon" Synflex 1300 Polyeten/Aluminium

6 mm svart	300 m/förp	21-150
8 mm svart	"	21-151
10 mm svart	100 m/förp	21-152
12 mm svart	100 & 300 m/förp	21-153



- Polyeten/Aluminium
- Temperaturområde -25° C - +80° C

Stålflätad slang syrafast

6 mm rörände L=300mm	27-103
6 mm rörände L=500mm	27-105
12 mm rörände L=300mm	27-113
12 mm rörände L=500mm	27-115
18 mm rörände L=300mm	27-123
18 mm rörände L=500mm	27-125



Kan beställas i valfri längd och med valfri storlek på ändarna.
Lite riktvärden. Max temp. 400°.
Ex. på tryck vid 20°, DN12 ca 70 bar, DN10 ca 100bar, DN6 ca 150 bar

Vid tex. 250°, reduceras trycket med ca 40% och vid 400° reduceras trycket med ca 52%.

Röravskärare för plaströr

Plast 1-15 mm	91-031
Reservblad	91-035



Stödhylsa för plastslang mässing

Till 6/4 mm slang	43-180
Till 8/6 mm slang	43-181
Till 10/8 mm slang	43-182
Till 12/10 mm slang	43-183



Stödhylsa för plastslang syrafast 2343

Till 6/4 mm slang	42-180
Till 8/6 mm slang	42-181
Till 10/8 mm slang	42-182
Till 12/10 mm slang	42-183
Till 16/14 mm slang	42-186



I.A.C. Komponenter AB

International Automation Components



P.O. Box 60, S-566 22 Habo • Phone: +46 (0)36 477 00 • Fax: +46 (0)36 477 15
E-mail: habo@iackomp.se • www.iackomp.se • Reg.No. 556461-2983



Pneumatisk kabel & slang

Instrumentrör och flerledarkabel

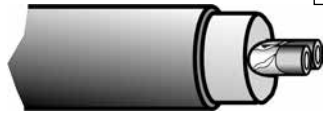
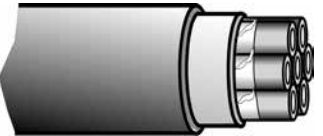
- Fabrikat: Osnaline, där inget annat anges • Flamsäker pvc-mantel standard, kan även levereras med flamsäker halogenfri LDPE-mantel.
- Singelslang levereras i kartonger om 250 m (6 mm), 100 m (8 mm), mantlad i 250m.
- Flerledarkabel levereras på trummor om ca 500 m.

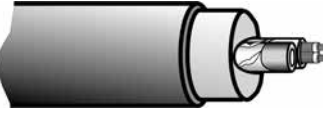
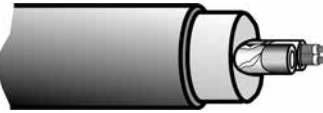
Rördimension	Typnr.	Artikelnummer	
Flerledarkabel polyeten/pvc-mantel			
	2 x 6 mm svart oval	7011	21-011
	2 x 6 mm svart	7011	21-012
	2 x 6 mm blå	7011	21-013
	2 x 8 mm svart	7011	21-016
	2 x 8 mm blå	7011	21-018
	3 x 6 mm svart	7011	21-043
	3 x 6 mm blå	7011	21-017
	7 x 6 mm svart	7011	21-024
	7 x 6 mm blå	7011	21-023
	12 x 6 mm svart	7011	21-028
	12 x 6 mm blå	7011	21-029
	2 x 1/4" svart	7011	21-010
	Flerledarkabel polyamid/pvc-mantel		
	2 x 6 mm svart	7031	21-351
	2 x 6 mm grön	7031	21-352
	2 x 8 mm svart	7031	21-354
	2 x 8 mm grön	7031	21-355
	2 x 10 mm svart	7031	21-357
	2 x 10 mm grön	7031	21-358
EI-pneumatisk kabel "IAC" polyeten/pvc-mantel			
	1 x 6 mm + PG 2x0.5 svart	IAC	21-031
	1 x 6 mm + PG 2x0.5 blå	IAC	21-034
	1 x 8 mm + PG 2x0.5 blå	IAC	21-032
	2 x 6 mm + PG 2x0.5 blå	IAC	21-033
	2 x 6 mm + PG 2x0.5 svart	IAC	21-035
	1 x 6 mm + PG 2x2x0.5 svart	IAC	21-0315
	1 x 6 mm + PG 2x2x0.5 blå	IAC	21-0345
	1 x 8 mm + PG 2x2x0.5 blå	IAC	21-0325
	2 x 6 mm + PG 2x2x0.5 blå	IAC	21-0335
	2 x 6 mm + PG 2x2x0.5 svart	IAC	21-0355
	2 x 8 mm + PG 2x2x0.5 blå	IAC	21-0338
	1 x 6 mm + 1x2x1,3 blå profibus	IAC	21-046
	EI-pneumatisk kabel "IAC" polyamid/pvc-mantel		
		1 x 6 mm + PG 2x0.5 svart	IAC
1 x 6 mm + PG 2x0.5 grön		IAC	21-382
1 x 10 mm + PG 2x0.5 grön		IAC	21-386
1 x 6 mm + PG 2x2x0.5 grön		IAC	21-3825
1 x 10 mm + PG 2x2x0.5 mm grön		IAC	21-3865
1 x 6 mm + KJAAM 2x2x0.5 svart		IAC	21-391
2 x 6 mm + KJAAM 2x2x0.5 svart		IAC	21-395
2 x 10 mm + ÖLFLEX 4 x 1 svart		IAC	21-399



I.A.C. Komponenter AB

International Automation Components

P.O. Box 60, S-566 22 Habo • Phone: +46 (0)36 477 00 • Fax: +46 (0)36 477 15
E-mail: habo@iackomp.se • www.iackomp.se • Reg.No. 556461-2983



Pneumatisk kabel & slang

Instrumentrör och flerledarkabel

- Fabrikat: Osnaline, där inget annat anges • Flamsäker pvc-mantel standard, kan även levereras med flamsäker halogenfri LDPE-mantel.
- Singelslang levereras i kartonger om 250 m (6 mm), 100 m (8 mm), mantlad i 250m.
- Flerledarkabel levereras på trummor om ca 500 m.

Rördimension	Typnr.	Artikelnummer
--------------	--------	---------------

Halogenfri Flerledarkabel polyeten/LDPE-mantel

2 x 6 mm blå	7011	21-413
7 x 6 mm svart		21-424



Halogenfri Flerledarkabel polyamid/LDPE-mantel

2 x 6 mm svart	7031	21-512
2 x 6 mm blå	7031	21-513
2 x 6 mm grön	7031	21-514
2 x 8 mm svart	7031	21-515
2 x 8 mm blå	7031	21-516
2 x 8 mm grön	7031	21-517
2 x 10 mm svart	7031	21-518
2 x 10 mm blå	7031	21-519
2 x 10 mm grön	7031	21-520



Halogenfri EI-pneumatisk kabel "IAC" polyamid/LDPE-mantel

1 x 6 mm + PG 2x0.5 blå	IAC	21-533
1 x 6 mm + PG 2x0.5 grön	IAC	21-534
1 x 6 mm + PG 2x2x0.5 grön	IAC	21-5345
1 x 8 mm + PG 2x0.5 blå	IAC	21-536
1 x 8 mm + PG 2x0.5 grön	IAC	21-537
1 x 8 mm + PG 2x2x0.5 grön	IAC	21-5375
1 x 10 mm + PG 2x0.5 svart	IAC	21-538
1 x 10 mm + PG 2x0.5 grön	IAC	21-540
1 x 10 mm + PG 2x2x0.5 grön	IAC	21-5405
2 x 6 mm + PG 2x2x0.5 svart	IAC	21-542
2 x 6 mm + PG 2x2x0.5 blå	IAC	21-543
2 x 8 mm + PG 2x2x0.5 blå	IAC	21-546
2 x 8 mm + PG 2x2x0.5 grön	IAC	21-547
2 x 10 mm + PG 2x2x0.5 svart	IAC	21-548
2 x 10 mm + PG 2x2x0.5 blå	IAC	21-549
1 x 6 mm + PG 2x1.0 blå	IAC	21-563
1 x 8 mm + PG 2x1.0 blå	IAC	21-566
2 x 8 mm + PG 2x2x1.0 blå	IAC	21-569



Halogenfri EI-pneumatisk kabel "IAC" polyeten/LDPE-mantel

1 x 6 mm + PG 2x0.5 svart	IAC	21-432
2 x 6 mm + PG 2x2x0.5 svart	IAC	21-442



I.A.C. Komponenter AB
International Automation Components

P.O. Box 60, S-566 22 Habo • Phone: +46 (0)36 477 00 • Fax: +46 (0)36 477 15
E-mail: habo@iackomp.se • www.iackomp.se • Reg.No. 556461-2983



Pneumatisk kabel & slang

Tabell över max arbetstryck (bar) av plaströr

Storlek mm	LDPE - Polyeten			HDPE - Polyeten			
	20°	40°	60°	20°	40°	60°	75°
4 x 1.0	16	8	4	33	16	8	5
6 x 1.0	10	5	2,5	20	10	5	3
8 x 1.0	7	3,5	1,5	14	7	3,5	2
10 x 1.0	5	2,5	1	11	5,5	2,5	1,5
12 x 1.0	4,5	2	1	9	4,5	2	1
1/4" x 0.040"	10	5	2,5	20	10	5	3
3/8" x 0.040"	6	3	1,5	12	6	3	1,5
3/8" x 0.062"	10	5	2,5	20	10	5	3
1/2" x 0.062"	7	3,5	1,5	14	7	3,5	2

Storlek mm	PA 11/12 w - Polyamid					PTFE - Teflon				
	20°	40°	60°	80°	100°	20°	50°	100°	150°	200°
4 x 1.0	33	24	19	16	13	24	18	13	10	8
6 x 1.0	20	14	11	9,5	7,5	15	11	8	6	5
8 x 1.0	14	10	8	6,5	5,5	11	8,5	6	4,5	3,5
10 x 1.0	11	8	6	5	4	8	6	4	3	2,5
12 x 1.0	9	6,5	5	4	3,5	6,5	5	3,5	2,5	2
1/4" x 0.040"	20	14	11	9,5	7,5	14	11	7,5	5,5	4,5
3/8" x 0.040"	12	8,5	6,5	5,5	4,5	8,5	6,5	4,5	3,5	2,5
3/8" x 0.062"	20	14	11	9,5	7,5	14	11	7,5	5,5	4,5
1/2" x 0.062"	14	10	8	6,5	5,5	10	8	5,5	4	3

- 4-faldig säkerhet mot sprängtryck
- Mantel PVC YM3 till VDE 0207 - temperatur upp till 70° C (standard)
- Mantel PVC YM4 till VDE 0209 - temperatur upp till 100° C (mot order)
- Mantel LDPE - temperatur upp till 70° C (standard)

Tabell över diameter på kabel

Typ	Beskrivning	Diameter ca:
7011, 7031	2 x 6 mm	17 mm
7011, 7031	2 x 8 mm	23 mm
7031	2 x 10 mm	28 mm
7011	12 x 6 mm	32 mm
IAC	1 x 6 mm + 2 x 0,5 mm	18 mm
IAC	1 x 6 mm + 2 x 2 x 0,5 mm	19 mm
IAC	2 x 6 mm + 2 x 0,5 mm	19 mm
IAC	2 x 6 mm + 2 x 2 x 0,5 mm	19 mm
IAC	1 x 8 mm + 2 x 0,5 mm	21 mm
IAC	2 x 8 mm + 2 x 2 x 0,5 mm	23 mm
IAC	1 x 6 mm + 2 x (2+1) x 0,5 mm	19 mm
IAC	2 x 6 mm + 2 x (2+1) x 0,5 mm	21 mm
IAC	2 x 10 mm + öflex 4 x 1 mm	28 mm



I.A.C. Komponenter AB
International Automation Components

P.O. Box 60, S-566 22 Habo • Phone: +46 (0)36 477 00 • Fax: +46 (0)36 477 15
E-mail: habo@iackomp.se • www.iackomp.se • Reg.No. 556461-2983

Pneumatisk kabel & slang

Tabell över max arbetstryck (bar) av plaströr

Kvalitet Hårdhet Temp. område Slangstorlek i mm.		PA (=PA12P40) 60 Shore D (medelhård) -40 till +80°C Arbetstryck i bar med säkerhetsfaktor = 3 vid följande olika temperaturer Temperatur (°C)				Vikt	Min. böjradie
ytter-Ø	inner-Ø	23	40	60	80	g/m	mm
4,0	2,7	26	19	15	12	7,2	24
5,0	3,2	29	21	17	14	12,2	30
6,0	4,2	23	17	13	11	15,1	36
8,0	6,0	19	14	11	9	23,1	50
10,0	8,0	14	10	8	7	29,7	80
12,0	10,0	12	9	7	6	36,3	118
14,0	12,0	10	7	6	5	42,9	163
15,0	12,5	12	9	7	6	26,7	147

Kvalitet Hårdhet Temp. område Slangstorlek i mm.		PUR (=PUR C98A) 98 Shore A & 52 Shore D (mjuk) -40 till +80°C Arbetstryck i bar med säkerhetsfaktor = 3 vid följande olika temperaturer Temperatur (°C)						Vikt	Min. böjradie
ytter-Ø	inner-Ø	20	30	40	50	60	70	g/m	mm
4,0	2,2	17	15	13	11	10	9	11	10
5,0	3,1	13	12	10	9	8	7	15	15
6,0	3,9	12	11	9	8	7	7	20	20
8,0	5,7	10	9	7	7	6	5	30	34
10,0	7,5	8	7	6	6	5	4	42	50
12,0	9,0	8	7	6	6	5	4	60	60
14,0	11,0	7	6	5	5	4	4	72	83



I.A.C. Komponenter AB
International Automation Components

P.O. Box 60, S-566 22 Habo • Phone: +46 (0)36 477 00 • Fax: +46 (0)36 477 15
E-mail: habo@iackomp.se • www.iackomp.se • Reg.No. 556461-2983

Pneumatisk slang

Tabell över max arbetstryck (bar) av plaströr

Kvalitet			PV		Min. böj-radie
Hårdhet Temp. område Slangstorlek i mm.			Innerlager: 85±3 Shore A Ytterlager: 80±5 Shore A -10 till +60 °C Arbetstryck i bar med säkerhetsfaktor = 3,5 vid följande olika temperaturer Temperatur (°C)		
	ytter-Ø	inner-Ø	20	60	mm
6/4	6,20	4,0	40	28	50
8/6	8,20	6,0	35	24	60
10/8	10,20	8,0	35	24	65
12/10	12,50	10,0	28	20	80

Kvalitet		PAUR		Min. böjradie
Temp. område Slangstorlek i mm.		-40 till +100 °C Arbetstryck i bar vid följande olika temperaturer Temperatur (°C)		
ytter-Ø	inner-Ø	23	mm	
4	2,5	22	10	
6	4,0	19	15	
8	6,0	16	25	
10	8,0	12	35	
12	10,0	8	60	
14	12	16	50	



I.A.C. Komponenter AB
International Automation Components

P.O. Box 60, S-566 22 Habo • Phone: +46 (0)36 477 00 • Fax: +46 (0)36 477 15
E-mail: habo@iackomp.se • www.iackomp.se • Reg.No. 556461-2983

Slangkopplingar

Plaströrskopplingar

- Fabrikat: Cielle • Förkromad mässing • Påstickskoppling med klämmutter.
- BSPT (KR) - Europeisk konisk rörgänga • BSPP (R) - Europeisk cylindrisk rörgänga.



Rördim. x gänga

Artikelnummer

Rak koppling utv. gänga

BSPT (KR)

6/4 mm x 1/8"	43-101
6/4 mm x 1/4"	43-102
6/4 mm x 3/8"	43-103
6/4 mm x 1/2"	43-104
8/6 mm x 1/8"	43-106
8/6 mm x 1/4"	43-107
8/6 mm x 3/8"	43-108
10/8 mm x 1/8"	43-109
10/8 mm x 1/4"	43-1091
10/8 mm x 3/8"	43-1092
10/8 mm x 1/2"	43-1093
12/10 mm x 3/8"	43-1095
12/10 mm x 1/2"	43-1096
1/4" x 1/8"	43-001
1/4" x 1/4"	43-002
3/8" x 1/8"	43-006
3/8" x 1/4"	43-007



Rak koppling utv. gänga med o-ring

BSPP (R)

6/4 mm x M5	43-1905
6/4 mm x 1/8"	43-190
6/4 mm x 1/4"	43-191
12/10 mm x 3/8"	43-1976



Rak koppling inv. gänga

BSPP (R)

6/4 mm x 1/8"	43-130
6/4 mm x 1/4"	43-131
6/4 mm x 3/8"	43-132
8/6 mm x 1/8"	43-135
8/6 mm x 1/4"	43-136
8/6 mm x 3/8"	43-137
10/8 mm x 1/8"	43-1371
10/8 mm x 1/4"	43-1372
10/8 mm x 3/8"	43-1373
10/8 mm x 1/2"	43-1374
12/10 mm x 3/8"	43-1376



Vinkelkoppling utv. gänga

BSPT (KR)

6/4 mm x 1/8"	43-110
6/4 mm x 1/4"	43-111
6/4 mm x 3/8"	43-112
8/6 mm x 1/8"	43-115
8/6 mm x 1/4"	43-116
8/6 mm x 3/8"	43-117
10/8 mm x 1/8"	43-1171
10/8 mm x 1/4"	43-1172
10/8 mm x 3/8"	43-1173
10/8 mm x 1/2"	43-1174
12/10 mm x 3/8"	43-1176
12/10 mm x 1/2"	43-1177



I.A.C. Komponenter AB

International Automation Components

P.O. Box 60, S-566 22 Habo • Phone: +46 (0)36 477 00 • Fax: +46 (0)36 477 15

E-mail: habo@iackomp.se • www.iackomp.se • Reg.No. 556461-2983

Slangkopplingar

Plaströrkopplingar

- Fabrikat: Cielle • Förokromad mässing • Påstickskoppling med klämmutter.
- BSPT (KR) - Europeisk konisk rörgänga • BSPP (R) - Europeisk cylindrisk rörgänga.



Rördim. x gänga

Artikelnummer

Vinkelkoppling vridbar utv. gänga med o-ring BSPP (R)

6/4 mm x 1/8"	43-118
6/4 mm x 1/4"	43-119
8/6 mm x 1/8"	43-127
8/6 mm x 1/4"	43-128
1/4" x 1/8"	43-018
1/4" x 1/4"	43-019
3/8" x 1/8"	43-027
3/8" x 1/4"	43-028



Vinkelkoppling inv. gänga BSPP (R)

6/4 mm x 1/8"	43-120
6/4 mm x 1/4"	43-121
8/6 mm x 1/8"	43-125
8/6 mm x 1/4"	43-126
10/8 mm x 1/4"	43-1262
12/10 mm x 3/8"	43-1266



Skarvkoppling

6/4 mm	43-140
8/6 mm	43-141
10/8 mm	43-142
12/10 mm	43-1421
1/4"	43-040
3/8"	43-041



Reduceringskoppling

8/6 mm x 6/4 mm	43-1432
10/8 mm x 6/4 mm	43-1434
10/8 mm x 8/6 mm	43-143



Skottgenomföring

6/4 mm	43-145
8/6 mm	43-146
10/8 mm	43-147
12/10 mm	43-148
1/4"	43-045
3/8"	43-046



T-koppling

6/4 mm	43-165
8/6 mm	43-166
10/8 mm	43-167
12/10 mm	43-168
1/4"	43-065
3/8"	43-066









I.A.C. Komponenter AB
International Automation Components

P.O. Box 60, S-566 22 Habo • Phone: +46 (0)36 477 00 • Fax: +46 (0)36 477 15
E-mail: habo@iackomp.se • www.iackomp.se • Reg.No. 556461-2983

Slangkopplingar

Plaströrskopplingar

- Fabrikat: Cielle • Förkromad mässing • Påstickskoppling med klämmutter.
- BSPT (KR) - Europeisk konisk rörgänga • BSPP (R) - Europeisk cylindrisk rörgänga.

Rördim. x gänga	Artikelnummer
	T-koppling utv. gänga BSPT (KR)
6/4 mm x 1/8"	43-150
6/4 mm x 1/4"	43-151
8/6 mm x 1/8"	43-152
8/6 mm x 1/4"	43-153
10/8 mm x 1/8"	43-1531
10/8 mm x 1/4"	43-1532
10/8 mm x 3/8"	43-1533
10/8 mm x 1/2"	43-1534
12/10 mm x 3/8"	43-1536
12/10 mm x 1/2"	43-1537
	T-koppling vridbar utv. gänga med teflon BSPT (KR)
6/4 mm x 1/4"	43-163
	L-koppling utv. gänga BSPT (KR)
6/4 mm x 1/8"	43-155
6/4 mm x 1/4"	43-156
6/4 mm x 3/8"	43-157
8/6 mm x 1/8"	43-1581
8/6 mm x 1/4"	43-158
8/6 mm x 3/8"	43-159
10/8 mm x 1/8"	43-160
10/8 mm x 1/4"	43-161
	Mutter
6 mm	43-170
8 mm	43-173
10 mm	43-176
12 mm	43-178
1/4"	43-171
3/8"	43-174
	Rak koppling utv. gänga med teflontätning BSPT (KR)
6/4 mm x 1/8"	43-301
6/4 mm x 1/4"	43-302
6/4 mm x 3/8"	43-303
8/6 mm x 1/4"	43-307
10/8 mm x 1/8"	43-309
10/8 mm x 1/4"	43-3091
	Vinkelkoppling vridbar utv. gänga med teflontätning BSPT (KR)
6/4 mm x 1/8"	43-310
6/4 mm x 1/4"	43-311
8/6 mm x 1/8"	43-315
8/6 mm x 1/4"	43-316
10/8 mm x 1/4"	43-3172
	T-koppling vridbar utv. gänga med teflontätning BSPP (R)
6/4 mm x 1/8"	43-320
6/4 mm x 1/4"	43-321
8/6 mm x 1/8"	43-322
8/6 mm x 1/4"	43-323
10/8 mm x 1/4"	43-324



I.A.C. Komponenter AB

International Automation Components

P.O. Box 60, S-566 22 Habo • Phone: +46 (0)36 477 00 • Fax: +46 (0)36 477 15

E-mail: habo@iackomp.se • www.iackomp.se • Reg.No. 556461-2983

Slangkopplingar

Plaströrkopplingar

- Fabrikat: Legris • Mässing
- NPT - Amerikansk konisk rörgänga

Rördim. x gänga	Artikelnummer
Rak koppling utv. gänga	NPT
6 mm x 1/8"	43-210
6 mm x 1/4"	43-211
8 mm x 1/4"	43-213
10 mm x 1/4"	43-214
Vinkelkoppling utv. gänga	NPT
6 mm x 1/8"	43-216
6 mm x 1/4"	43-217
Skarvkoppling rak	
6 mm	43-222
Skottgenomföring	
6 mm	43-225
T-koppling	
6 mm	43-237
Skärning	
6 mm	43-256
Mutter	
6 mm	43-246



I.A.C. Komponenter AB
International Automation Components

P.O. Box 60, S-566 22 Habo • Phone: +46 (0)36 477 00 • Fax: +46 (0)36 477 15
E-mail: habo@iackomp.se • www.iackomp.se • Reg.No. 556461-2983

Slangkopplingar

Slangkopplingar

- Fabrikat - ©: C.Matic • Syrafast stål 316 - 2343
- Påstickskoppling med klämmutter för plastslang.
- BSPT (KR) - Europeisk konisk rörgänga • BSPP (R) - Europeisk cylindrisk rörgänga
- Finns även i andra dimensioner och utföranden

Rördim. x gänga	Typnr.	Artikelnummer
Rak anslutning utv. gänga		
BSPT (KR)		
6 mm x 1/8"	CX110618	47-201
6 mm x 1/4"	CX110614	47-202
8 mm x 1/8"	CX110818	47-204
8 mm x 1/4"	CX110814	47-205
10 mm x 1/4"	CX111014	47-207
10 mm x 3/8"	CX111038	47-208
Vinkelkoppling utv. gänga		
BSPT (KR)		
6 mm x 1/8"	CX140618	47-210
6 mm x 1/4"	CX140614	47-211
8 mm x 1/8"	CX140818	47-213
8 mm x 1/4"	CX140814	47-214
10 mm x 1/4"	CX141014	47-216
Skarvkoppling rak		
6 mm	CX260606	47-240
8 mm	CX260808	47-241
10 mm	CX261010	47-242
Skarvkoppling vinkel		
6 mm	CX280006	47-245
8 mm	CX280008	47-246
10 mm	CX280010	47-247
T-koppling utv. gänga		
BSPT (KR)		
6 mm x 1/8"	CX200618	47-250
6 mm x 1/4"	CX200614	47-251
8 mm x 1/8"	CX200818	47-252
8 mm x 1/4"	CX200814	47-253
10 mm x 1/4"	CX201014	47-254
L-koppling utv. gänga		
BSPT (KR)		
6 mm x 1/8"	CX230618	47-255
6 mm x 1/4"	CX230614	47-256
8 mm x 1/8"	CX230818	47-257
8 mm x 1/4"	CX230814	47-258
10 mm x 1/4"	CX231014	47-259
T-koppling		
6 mm	CX290006	47-265
8 mm	CX290008	47-266
10 mm	CX290010	47-267
Mutter		
6 mm	CX100610	47-270
8 mm	CX100812	47-271
10 mm	CX101014	47-272



I.A.C. Komponenter AB
International Automation Components

P.O. Box 60, S-566 22 Habo • Phone: +46 (0)36 477 00 • Fax: +46 (0)36 477 15
E-mail: habo@iackomp.se • www.iackomp.se • Reg.No. 556461-2983

Slangkopplingar

Plaströrkopplingar

- Fabrikat: SR-Sprint • Förnickladd mässing med teflontätning
- Instickskoppling med gripringslåsning • BSPT (KR) - Europeisk konisk rörgänga.
- BSPP (R) - Europeisk cylindrisk rörgänga • Går att montera med skyddshuv som förhindrar smuts att tränga in i kopplingen.



Rördim. x gänga

Artikelnummer

Rak anslutning utv. gänga

BSPP (R)

4 mm x 1/8"	46-101
4 mm x 1/4"	46-102
6 mm x 1/8"	46-103
6 mm x 1/4"	46-104
8 mm x 1/8"	46-105
8 mm x 1/4"	46-106
8 mm x 3/8"	46-107
10 mm x 1/4"	46-108
10 mm x 3/8"	46-109
10 mm x 1/2"	46-110
12 mm x 1/4"	46-111
12 mm x 3/8"	46-112
12 mm x 1/2"	46-113
4 mm x M5 o-ring	46-1015
6 mm x M5 o-ring	46-1035



Rak anslutning inv. gänga

BSPP (R)

6 mm x 1/8"	46-117
6 mm x 1/4"	46-118
8 mm x 1/8"	46-119
8 mm x 1/4"	46-120
10 mm x 1/4"	46-1203



Vinkelkoppling utv. gänga

BSPT (KR)

6 mm x 1/8"	46-023
6 mm x 1/4"	46-024
8 mm x 1/8"	46-025
8 mm x 1/4"	46-026
8 mm x 3/8"	46-027
10 mm x 1/4"	46-028
10 mm x 3/8"	46-029
12 mm x 1/4"	46-030
12 mm x 3/8"	46-031



Vinkelkoppling vridbar utv. gänga

BSPP (R)

4 mm x 1/8"	46-121
4 mm x 1/4"	46-122
6 mm x 1/8"	46-123
6 mm x 1/4"	46-124
8 mm x 1/8"	46-125
8 mm x 1/4"	46-126
8 mm x 3/8"	46-127
10 mm x 1/4"	46-128
10 mm x 3/8"	46-129
10 mm x 1/2"	46-130
12 mm x 1/4"	46-131
12 mm x 3/8"	46-132
12 mm x 1/2"	46-133
4 mm x M5 o-ring	46-1215
6 mm x M5 o-ring	46-1235



I.A.C. Komponenter AB
International Automation Components

P.O. Box 60, S-566 22 Habo • Phone: +46 (0)36 477 00 • Fax: +46 (0)36 477 15
E-mail: habo@iackomp.se • www.iackomp.se • Reg.No. 556461-2983

Slangkopplingar

Plaströrkopplingar

- Fabrikat: SR-Sprint • Förnickladd mässing med teflontätning
- Instickskoppling med griplingslåsning • BSPT (KR) - Europeisk konisk rörgänga.
- BSPP (R) - Europeisk cylindrisk rörgänga • Går att montera med skyddshuv som förhindrar smuts att tränga in i kopplingen.



Rördim. x gänga

Artikelnummer

T-koppling vridbar utv. gänga

BSPP (R)

4 mm x 1/8"	46-141
6 mm x 1/8"	46-143
6 mm x 1/4"	46-144
8 mm x 1/8"	46-145
8 mm x 1/4"	46-146
8 mm x 3/8"	46-147
10 mm x 1/4"	46-148
10 mm x 3/8"	46-149
12 mm x 1/4"	46-150
12 mm x 3/8"	46-151
12 mm x 1/2"	46-152



L-koppling vridbar utv. gänga

BSPP (R)

6 mm x 1/8"	46-157
6 mm x 1/4"	46-158
8 mm x 1/8"	46-159
8 mm x 1/4"	46-160
8 mm x 3/8"	46-161
10 mm x 1/4"	46-162
10 mm x 3/8"	46-163
12 mm x 3/8"	46-165



Skarvkoppling rak

4 mm	46-080
6 mm	46-081
8 mm	46-082
10 mm	46-083
12 mm	46-084
6 mm x 4 mm	46-256
8 mm x 6 mm	46-257
10 mm x 8 mm	46-258
12 mm x 10 mm	46-259



T-koppling

4 mm	46-090
6 mm	46-091
8 mm	46-092
10 mm	46-093
12 mm	46-094



Y-skarvkoppling

4 mm	46-0945
6 mm	46-095
8 mm	46-096
10 mm	46-097
12 mm	46-098



Skarvkoppling vinkel

4 mm	46-250
6 mm	46-251
8 mm	46-252
10 mm	46-253
12 mm	46-254



I.A.C. Komponenter AB
International Automation Components

P.O. Box 60, S-566 22 Habo • Phone: +46 (0)36 477 00 • Fax: +46 (0)36 477 15
E-mail: habo@iackomp.se • www.iackomp.se • Reg.No. 556461-2983

Slangkopplingar

Plaströrkopplingar

- Fabrikat: SR-Sprint • Förnicklad mässing med teflontätning
- Instickskoppling med gripringslåsning • BSPT (KR) - Europeisk konisk rörgänga.
- BSPP (R) - Europeisk cylindrisk rörgänga • Går att montera med skyddshuv som förhindrar smuts att tränga in i kopplingen.



Rördimension

Artikelnummer

Kopplingsplugg

4 mm	46-210
6 mm	46-211
8 mm	46-212
10 mm	46-213
12 mm	46-214



Korskoppling

4 mm	46-231
6 mm	46-232
8 mm	46-233
10 mm	46-234
12 mm	46-235



Skottgenomföring

4 mm	46-180
6 mm	46-181
8 mm	46-182
10 mm	46-183
12 mm	46-184



Skyddshuv

4 mm svart	46-200
6 mm svart	46-201
8 mm svart	46-202
10 mm svart	46-203
12 mm svart	46-204



Reducerings adapter

4 mm x YD6	46-240
6 mm x YD8	46-241
6 mm x YD10	46-242
6 mm x YD12	46-243
8 mm x YD10	46-244
8 mm x YD12	46-245
10 mm x YD12	46-246



Markör ring

4 mm röd	46-1911
4 mm blå	46-1912
4 mm grön	46-1913
6 mm röd	46-1921
6 mm blå	46-1922
6 mm grön	46-1923
8 mm röd	46-1931
8 mm blå	46-1932
8 mm grön	46-1933
10 mm röd	46-1941
10 mm blå	46-1942
10 mm grön	46-1943
12 mm röd	46-1951
12 mm blå	46-1952
12 mm grön	46-1953



I.A.C. Komponenter AB

International Automation Components

P.O. Box 60, S-566 22 Habo • Phone: +46 (0)36 477 00 • Fax: +46 (0)36 477 15

E-mail: habo@iackomp.se • www.iackomp.se • Reg.No. 556461-2983

Slangkopplingar

Plaströrkopplingar

- Fabrikat: Legris • Polyamid med gängdel i förnicklad mässing.
- Instickskoppling med griplingslåsning
- Finns även i andra dimensioner, utföranden och med andra gängor.

Rördim. x gänga

Artikelnummer

Rak anslutning utv. gänga

BSPT

BSPP

6 mm x 1/8"	45-003	45-103
6 mm x 1/4"	45-004	45-104
8 mm x 1/8"	45-005	45-105
8 mm x 1/4"	45-006	45-106
8 mm x 3/8"	45-007	45-107
10 mm x 1/4"	45-008	45-108
10 mm x 3/8"	45-009	–

Rak anslutning inv. gänga

BSPT

BSPP

6 mm x 1/8"	–	45-117
6 mm x 1/4"	–	45-118
8 mm x 1/8"	–	45-119
8 mm x 1/4"	–	45-120

Vinkelkoppling vridbar utv. gänga

BSPT

BSPP

6 mm x 1/8"	45-023	45-123
6 mm x 1/4"	45-024	45-124
8 mm x 1/8"	45-025	45-125
8 mm x 1/4"	45-026	45-126
8 mm x 3/8"	45-027	45-127
10 mm x 1/4"	45-028	45-128
10 mm x 3/8"	45-029	45-129

T-koppling utv. gänga

BSPT

BSPP

6 mm x 1/8"	45-043	45-143
6 mm x 1/4"	45-044	45-144
8 mm x 1/8"	45-045	45-145
8 mm x 1/4"	45-046	45-146
8 mm x 3/8"	45-047	45-147

L-koppling utv. gänga

BSPT

BSPP

6 mm x 1/8"	45-057	45-157
6 mm x 1/4"	45-058	45-158
8 mm x 1/8"	45-059	45-159
8 mm x 1/4"	45-060	45-160
8 mm x 3/8"	45-061	45-161

Y-koppling utv. gänga

BSPT

BSPP

6 mm x 1/8"	45-073	45-173
6 mm x 1/4"	45-074	45-174
8 mm x 1/8"	45-075	45-175
8 mm x 1/4"	45-076	45-176

Skarvkoppling rak

6 mm	45-081
8 mm	45-082
10 mm	45-083

Skarvkoppling vinkel

6 mm	45-086
8 mm	45-087
10 mm	45-088



I.A.C. Komponenter AB

International Automation Components

P.O. Box 60, S-566 22 Habo • Phone: +46 (0)36 477 00 • Fax: +46 (0)36 477 15
E-mail: habo@iackomp.se • www.iackomp.se • Reg.No. 556461-2983

Slangkopplingar

Plaströrkopplingar

- Fabrikat: Legris • Polyamid med gängdel i förnicklad mässing.
- Instickskoppling med griplingslåsnig
- Finns även i andra dimensioner, utföranden och med andra gängor.



Rördimension

Artikelnummer

T-koppling

6 mm	45-091
8 mm	45-092
10 mm	45-093



Y-skarvkoppling

6 mm	45-095
8 mm	45-096



Y-insticksanslutning

6 mm	45-098
8 mm	45-099



Vinkel insticksanslutning

6 mm	45-221
8 mm	45-222



Luftplint 2-vägs

6 mm	45-181
8 mm	45-182



Luftplint 3-vägs

6 mm	45-186
8 mm	45-187



Kopplingsplugg

6 mm	45-211
8 mm	45-212
10 mm	45-213



Reduceringskoppling

8 mm x 6 mm	45-227
10 mm x 8 mm	45-229



Markör ring

6 mm röd	45-191
6 mm grön	45-192
6 mm blå	45-194
8 mm röd	45-196
8 mm grön	45-197
10 mm röd	45-199
10 mm grön	45-200



I.A.C. Komponenter AB

International Automation Components

P.O. Box 60, S-566 22 Habo • Phone: +46 (0)36 477 00 • Fax: +46 (0)36 477 15

E-mail: habo@iackomp.se • www.iackomp.se • Reg.No. 556461-2983

Slangkopplingar

Plaströrkopplingar

- Fabrikat: Swift Fit • Technopolymer med gängdel i förnicklad mässing • Instickskoppling med griplingslåsning
- Finns även i andra dimensioner och utföranden.

Rördim. x gänga

Artikelnummer

Rak anslutning utv. gänga

6 mm x 1/8"	45-303
6 mm x 1/4"	45-304
6 mm x 1/2"	45-306
10 mm x 1/4"	45-308
10 mm x 3/8"	45-309

Vinkelkoppling vridbar utv. gänga

6 mm x 1/8"	45-323
6 mm x 1/4"	45-324
8 mm x 1/4"	45-326
10 mm x 1/4"	45-328
10 mm x 3/8"	45-330

T-koppling vridbar utv. gänga

6 mm x 1/8"	45-343
6 mm x 1/4"	45-344
10 mm x 1/4"	45-348

Skarvkoppling rak

6 mm	45-381
8 mm	45-382
10 mm	45-383

T-koppling

6 mm	45-391
10 mm	45-393



I.A.C. Komponenter AB

International Automation Components

P.O. Box 60, S-566 22 Habo • Phone: +46 (0)36 477 00 • Fax: +46 (0)36 477 15

E-mail: habo@iackomp.se • www.iackomp.se • Reg.No. 556461-2983

Slangkopplingar

Rör & slangkopplingar

- Fabrikat - ©: C.Matic • Syrafast stål 316 - 2343
- Instickskoppling med gripringslåsning för plast och metallrör
- BSPT (KR) - Europeisk konisk rörgänga • BSPP (R) - Europeisk cylindrisk rörgänga
- Finns även i andra dimensioner och utföranden

Rördim. x gänga	Typnr.	Artikelnummer
-----------------	--------	---------------

Rak anslutning utv. gänga	BSPT (KR)
---------------------------	-----------



6 mm x 1/8"	MX110618	47-003
6 mm x 1/4"	MX110614	47-004
8 mm x 1/8"	MX110818	47-005
8 mm x 1/4"	MX110814	47-006
8 mm x 3/8"	MX110838	47-007
10 mm x 1/4"	MX111014	47-008
10 mm x 3/8"	MX111038	47-009
10 mm x 1/2"	MX111012	47-010
12 mm x 1/4"	MX111214	47-011
12 mm x 3/8"	MX111238	47-012
12 mm x 1/2"	MX111212	47-0125

Rak anslutning utv. gänga	BSPP (R)
---------------------------	----------



6 mm x 1/8"	MX120618	47-013
6 mm x 1/4"	MX120614	47-014
8 mm x 1/8"	MX120818	47-015
8 mm x 1/4"	MX120814	47-016
8 mm x 3/8"	MX120838	47-017
10 mm x 1/4"	MX121014	47-018
10 mm x 3/8"	MX121038	47-019
10 mm x 1/2"	MX121012	47-020
12 mm x 1/4"	MX121214	47-021
12 mm x 3/8"	MX121238	47-0215
12 mm x 1/2"	MX121212	47-022

Vinkelkoppling vridbar utv. gänga	BSPT (KR)
-----------------------------------	-----------



6 mm x 1/8"	MX150618	47-023
6 mm x 1/4"	MX150614	47-024
8 mm x 1/8"	MX150818	47-025
8 mm x 1/4"	MX150814	47-026
8 mm x 3/8"	MX150838	47-027
10 mm x 1/4"	MX151014	47-028
10 mm x 3/8"	MX151038	47-029
10 mm x 1/2"	MX151012	47-030
12 mm x 1/4"	MX151214	47-031
12 mm x 3/8"	MX151238	47-032
12 mm x 1/2"	MX151212	47-0325

Vinkelkoppling vridbar utv. gänga	BSPP (R)
-----------------------------------	----------



6 mm x 1/8"	MX160618	47-033
6 mm x 1/4"	MX160614	47-034
8 mm x 1/8"	MX160818	47-035
8 mm x 1/4"	MX160814	47-036
8 mm x 3/8"	MX160838	47-037
10 mm x 1/4"	MX161014	47-038
10 mm x 3/8"	MX161038	47-039
10 mm x 1/2"	MX161012	47-040
12 mm x 1/4"	MX161214	47-041
12 mm x 3/8"	MX161238	47-042
12 mm x 1/2"	MX161212	47-0425



I.A.C. Komponenter AB

International Automation Components

P.O. Box 60, S-566 22 Habo • Phone: +46 (0)36 477 00 • Fax: +46 (0)36 477 15

E-mail: habo@iackomp.se • www.iackomp.se • Reg.No. 556461-2983

Slangkopplingar

Rör & slangkopplingar

- Fabrikat - ©: C.Matic • Syrafast stål 316 - 2343
- Instickskoppling med gripringslösning för plast och metallrör
- BSPT (KR) - Europeisk konisk rörgänga • BSPP (R) - Europeisk cylindrisk rörgänga
- Finns även i andra dimensioner och utföranden



Rördim. x gänga	Typnr.	Artikelnummer
-----------------	--------	---------------

T-koppling vridbar utv. gänga		BSPT (KR)
-------------------------------	--	-----------

6 mm x 1/8"	MX200618	47-043
6 mm x 1/4"	MX200614	47-044
8 mm x 1/8"	MX200818	47-045
8 mm x 1/4"	MX200814	47-046
10 mm x 1/4"	MX201014	47-048
10 mm x 3/8"	MX201038	47-049
12 mm x 3/8"	MX201238	47-050
12 mm x 1/2"	MX201212	47-051



T-koppling vridbar utv. gänga		BSPP (R)
-------------------------------	--	----------

6 mm x 1/8"	MX210618	47-053
6 mm x 1/4"	MX210614	47-054
8 mm x 1/8"	MX210818	47-055
8 mm x 1/4"	MX210814	47-056
10 mm x 1/4"	MX211014	47-057
10 mm x 3/8"	MX211038	47-058
12 mm x 3/8"	MX211238	47-059
12 mm x 1/2"	MX211212	47-060



Skottgenomföring		
------------------	--	--

6 mm	MX270606	47-071
8 mm	MX270808	47-072
10 mm	MX271010	47-073
12 mm	MX271212	47-074



Reduceringsadapter		
--------------------	--	--

6 mm x YD8	MX250608	47-077
6 mm x YD10	MX250610	47-0775
8 mm x YD10	MX250810	47-078
8 mm x YD12	MX250812	47-079
10 mm x YD12	MX251012	47-080



Skarvkoppling rak		
-------------------	--	--

6 mm	MX260606	47-081
8 mm	MX260808	47-082
10 mm	MX261010	47-083
12 mm	MX261212	47-084



Skarvkoppling vinkel		
----------------------	--	--

6 mm	MX280606	47-086
8 mm	MX280808	47-087
10 mm	MX281010	47-088
12 mm	MX281212	47-089



T-koppling		
------------	--	--

6 mm	MX290606	47-091
8 mm	MX290808	47-092
10 mm	MX291010	47-093
12 mm	MX291212	47-094



I.A.C. Komponenter AB

International Automation Components

P.O. Box 60, S-566 22 Habo • Phone: +46 (0)36 477 00 • Fax: +46 (0)36 477 15
E-mail: habo@iackomp.se • www.iackomp.se • Reg.No. 556461-2983

Slangkopplingar

Plaströrskopplingar

- Fabrikat: AH • Polyamid • För plaströr med inv. diameter.
- Påstickskoppling med hullingslåsning alt. slangklämma.
- Finns även i dimension upp till inv. Ø 19 mm samt i andra utföranden.

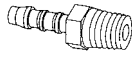

Rördim. x gänga	Typnr.	Artikelnummer
Rak koppling utv. gänga		BSPT (KR)

4 mm x 1/8"	GES 4-R 1/8	43-500
4 mm x 1/4"	GES 4-R 1/4	43-501
6 mm x 1/8"	GES 6-R 1/8	43-502
6 mm x 1/4"	GES 6-R 1/4	43-503

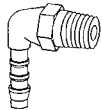

Vinkelkoppling utv. gänga		BSPT (KR)
----------------------------------	--	------------------

4 mm x 1/8"	WES 4-R 1/8	43-510
4 mm x 1/4"	WES 4-R 1/4	43-511
6 mm x 1/8"	WES 6-R 1/8	43-512
6 mm x 1/4"	WES 6-R 1/4	43-513

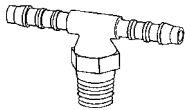

T-koppling utv. gänga		BSPT (KR)
------------------------------	--	------------------

4 mm x 1/8"	TES 4-R 1/8	43-550
4 mm x 1/4"	TES 4-R 1/4	43-551
6 mm x 1/8"	TES 6-R 1/8	43-552
6 mm x 1/4"	TES 6-R 1/4	43-553

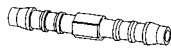

Skarvknoppling rak		
---------------------------	--	--

4 mm	GS 4	43-520
6 mm	GS 6	43-521



Skarvknoppling vinkel		
------------------------------	--	--

4 mm	WS 4	43-530
6 mm	WS 6	43-531

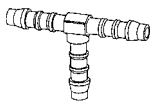

T-koppling		
-------------------	--	--

4 mm	TS 4	43-540
6 mm	TS 6	43-541

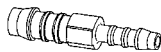

Reduceringskoppling		
----------------------------	--	--

6 x 4 mm	GRS 6-4	43-526
----------	---------	--------

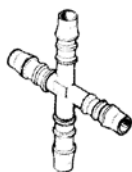

Korskoppling		
---------------------	--	--

4 mm	KS 4	43-545
6 mm	KS 6	43-546



I.A.C. Komponenter AB
International Automation Components

P.O. Box 60, S-566 22 Habo • Phone: +46 (0)36 477 00 • Fax: +46 (0)36 477 15
E-mail: habo@iackomp.se • www.iackomp.se • Reg.No. 556461-2983

Slangkopplingar

Snabbkopplingar

- Fabrikat: Camozzi • Förnicklad mässing
- BSPP (R) - Europeisk cylindrisk rörgänga
- Finns i standard och mini utförande



Dimension	Typnr.	Artikelnummer
Hona med utv. gänga		BSPP (R)
Hona x 1/4"	5081	43-851
Hona x 3/8"	5081	43-852
Hona x 1/2"	5081	43-853
Hona med inv. gänga		BSPP (R)
Hona x 1/4"	5083	43-856
Hona x 3/8"	5083	43-857
Hona x 1/2"	5083	43-858
Hane med utv. gänga		BSPP (R)
Hane x 1/4"	5180	43-871
Hane x 3/8"	5180	43-872
Hane x 1/2"	5180	43-873
Hane med inv. gänga		BSPP (R)
Hane x 1/4"	5380	43-876
Hane x 3/8"	5380	43-877
Hane x 1/2"	5380	43-878
Hona Mini med utv. gänga		BSPP (R)
Hona x 1/8"	5051	43-800
Hona x 1/4"	5051	43-801
Hona Mini med inv. gänga		BSPP (R)
Hona x 1/8"	5053	43-805
Hona x 1/4"	5053	43-806
Hona Mini med slangnippel		
Hona x 6 mm nippel	5056	43-815
Hona x 9 mm nippel	5056	43-816
Hona Mini med slangkoppling		
Hona x 6/4 mm slang	5054	43-810
Hona x 8/6 mm slang	5054	43-811
Hane Mini med utv. gänga		BSPP (R)
Hane x 1/8"	5150	43-820
Hane x 1/4"	5150	43-821
Hane Mini med inv. gänga		BSPP (R)
Hane x 1/8"	5350	43-825
Hane x 1/4"	5350	43-826
Hane Mini med slanganslutning		
Hane x 6/4 mm slang	5450	43-830
Hane x 8/6 mm slang	5450	43-831



I.A.C. Komponenter AB

International Automation Components

P.O. Box 60, S-566 22 Habo • Phone: +46 (0)36 477 00 • Fax: +46 (0)36 477 15

E-mail: habo@iackomp.se • www.iackomp.se • Reg.No. 556461-2983

Luftfördelningslist och tillbehör

- Fabrikat: IAC
- Profil i aluminium med kulventil i förnicklad mässing.
- Standard CC-mått 35 mm för 1/4" och 50 mm för 1/2".
- Vi tillverkar luftstam med uttag eller andra CC-mått enligt önskemål.



Dimension	Artikelnummer
Luftfördelningslist 1/4" med miniventiler	BSP
1 x 4 st uttag 1/8"	24-204
1 x 6 st uttag 1/8"	24-206
1 x 8 st uttag 1/8"	24-208
1 x 10 st uttag 1/8"	24-210
1 x 12 st uttag 1/8"	24-212
1 x 15 st uttag 1/8"	24-215
Kulventil Mini förnicklad mässing	BSP
1/8" utv. x inv.	61-020
1/4" utv. x inv.	61-021
1/8" utv. x 6 mm slang	61-030
1/4" utv. x 6 mm slang	61-031
Luftfördelningslist 1/2" med ventiler	BSP
1 x 6 st uttag 1/4"	24-006
1 x 8 st uttag 1/4"	24-008
1 x 10 st uttag 1/4"	24-010
1 x 12 st uttag 1/4"	24-011
2 x 6 st uttag 1/4"	24-012
2 x 12 st uttag 1/4", cc=40 mm	24-021
1 x 15 st uttag 1/4"	24-013
Luftfördelningslist 3/4" med ventiler	BSP
1 x 15 st uttag 1/4"	24-035
1 x 20 st uttag 1/4"	24-040
Kulventil förnicklad mässing	BSP
1/4" utv. x inv.	61-001
3/8" utv. x inv.	61-002
1/2" utv. x inv.	61-003
Rostfri luftfördelning 1/2" utan ventiler	BSP
1 x 4 st uttag 1/4"	24-051
1 x 6 st uttag 1/4"	24-052
1 x 8 st uttag 1/4"	24-053
1 x 10 st uttag 1/4"	24-054
Kulventil Mini syrafast	BSP
1/4" inv.	61-1502
Hållare för luftlist förzinkad plåt	
1/2" 6-kant	24-061
3/4" 6-kant	24-063
Hållare för luftlist rostfri	
1/2" vinkel	24-060



I.A.C. Komponenter AB
International Automation Components

P.O. Box 60, S-566 22 Habo • Phone: +46 (0)36 477 00 • Fax: +46 (0)36 477 15
E-mail: habo@iackomp.se • www.iackomp.se • Reg.No. 556461-2983

Luftfördelningslist

- Fabrikat: Bex • Anodiserad aluminiumlist med inbyggda on/off ventiler.
- Andra varianter mot förfrågan

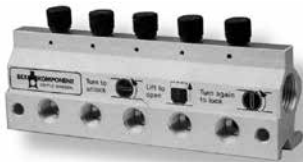

Dimension	Typnr.	Artikelnummer	
-----------	--------	---------------	--

Aluminiumprofil VL		BSP	NPT
3 st uttag 1/4"	L=111 mm VL-3	24-128	*
5 st uttag 1/4"	L=166 mm VL-5	24-130	*
6 st uttag 1/4"	L=194 mm VL-6	24-131	*
8 st uttag 1/4"	L=249 mm VL-8	24-133	*
10 st uttag 1/4"	L=303 mm VL-10	24-135	*
12 st uttag 1/4"	L=358 mm VL-12	24-137	*
15 st uttag 1/4"	L=441 mm VL-15	24-140	*
16 st uttag 1/4"	L=469 mm VL-16	24-141	*

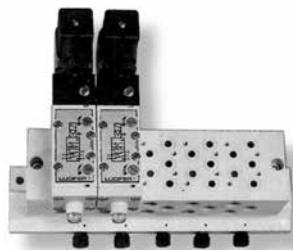

Blocklist LL/LB	BSP
-----------------	-----

För Lucifer 341L L=252 mm LL/LB-5-B	24-145
För Lucifer 341L L=288 mm LL/LB-6-B	24-146
För Lucifer 341L L=360 mm LL/LB-8-B	24-147
För Lucifer 341L L=432 mm LL/LB-10-B	24-148

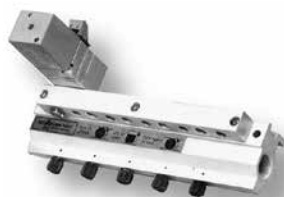

Blocklist VDOL	BSP
----------------	-----

För I/P-omv. VDO L=240 mm VDOL-5	24-150
För I/P-omv. VDO L=278 mm VDOL-6	24-151
För I/P-omv. VDO L=354 mm VDOL-8	24-153
För I/P-omv. VDO L=506 mm VDOL-12	24-155

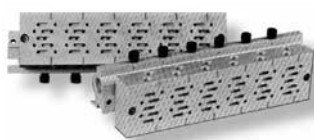

Blocklist för magnetventiler enl. ISO 5599/1	BSP
--	-----

För 5 st ISO 1 L=272 mm IL/IM-1AH-5	24-160
För 6 st ISO 1 L=315 mm IL/IM-1AH-6	24-161
För 8 st ISO 1 L=401 mm IL/IM-1AH-8	24-162
För 5 st ISO 2 L=347 mm IL/IM-2A-5	24-171
För 6 st ISO 2 L=390 mm IL/IM-2A-6	24-172
För 8 st ISO 2 L=502 mm IL/IM-2A-8	24-174

Täckplatta	
------------	--

LBP till LB-list	24-180
ILP-1 till IL-list ISO 1	24-182
ILP-2 till IL-list ISO 2	24-183

Distans plast	
---------------	--

46 x 60 för Lucifer 341P21	63-921
55 x 70 för Lucifer 341P22	63-922

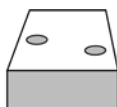

* mot order



I.A.C. Komponenter AB

International Automation Components

P.O. Box 60, S-566 22 Habo • Phone: +46 (0)36 477 00 • Fax: +46 (0)36 477 15
E-mail: habo@iackomp.se • www.iackomp.se • Reg.No. 556461-2983

Luftfördelning

Luftfördelningslist och tillbehör

- Fabrikat: Camozzi
- Luftfördelare i Teknopolymer med instickskoppling i metall.



Dimension	Artikelnummer
Luftfördelare Y	
6 mmS + 2 x 4 mmS	24-351
8 mmS + 2 x 6 mmS	24-352
Luftfördelare Rak	
6 mmS + 3 x 4 mmS	24-356
8 mmS + 3 x 6 mmS	24-357
Luftfördelare Kors	
6 mmS + 4 x 4 mmS	24-361
8 mmS + 4 x 6 mmS	24-362
Luftfördelare Rak aluminium	
1/4" R + 4 x 1/8" R	24-304



I.A.C. Komponenter AB
International Automation Components

P.O. Box 60, S-566 22 Habo • Phone: +46 (0)36 477 00 • Fax: +46 (0)36 477 15
E-mail: habo@iackomp.se • www.iackomp.se • Reg.No. 556461-2983

Luftbehandling

- Fabrikat: Camozzi, där inget annat anges.
- Finns även i andra dimensioner och utförande.



Dimension	Typnr.	Artikelnummer
Regulator Mini		
1/8" 0,5-10 bar	M008-R00	22-155
Regulator		
1/4" 0,5-10 bar	MC 104-R00	22-165
1/2" 0,5-10 bar	MC 202-R00	22-175
Regulator		
1" 0,5-10 bar	MX3-1-R000	22-185
Filterregulator		
1/4" 25µm 0,5-10 bar	MC 104-D00	22-161
1/2" 25µm 0,5-10 bar	MC 202-D00	22-171
Filter		
1/4" 25µm	MC 104-F00	22-163
1/2" 25µm	MC 202-F00	22-173
Dimsmörjare		
1/4"	MC 104-L00	22-167
1/2"	MC 202-L00	22-177
Mjukstart och avstängningsventil		
1/4" Mjukstartventil	MC 104-AV	22-169
1/4" Elventil exkl. els pole	MC 104-V16	22-1691
1/4" Luftventil	MC 104-V36	22-1692
Reducerventil "Norgren"		
		BSP
1/4" 0-7 bar	R07-200-RNKG	22-008
1/4" 0-7 bar med filter	B07-200-M3KG	22-050
Reducerventil "Bellofram"		
		NPT
1/4" 0-30 PSI	T-50	22-225
1/2" 0-30 PSI	T-70	22-230
Reducerventil "Fairchild"		
		NPT
3/8" 1-60 PSI	10243	22-235

Manometrar - se kapitel 14



I.A.C. Komponenter AB

International Automation Components

P.O. Box 60, S-566 22 Habo • Phone: +46 (0)36 477 00 • Fax: +46 (0)36 477 15
E-mail: habo@iackomp.se • www.iackomp.se • Reg.No. 556461-2983

Pneumatikventiler

Pneumatiska ventiler och tillbehör

- Fabrikat: Camozzi
- Finns även i andra dimensioner och utföranden

Dimension	Typnr.	Artikelnummer
Tryckvakt		
1/8" 1-10 bar	PM-11-NA+CAP	25-001
1/8" 1-10 bar	PM-11-NC+CAP	25-002
Magnetventil exkl. elspole		
24 mm fläns - 3/2	A231-BC2	25-201
1/8" - 2/2	A321-1C2	25-211
1/8" - 3/2	A331-1C2	25-212
Elstyrd ventil inkl. elspole		
1/8" - 5/2 - 24 VDC	E531-16-P13	25-215
1/8" - 5/2 - 24 VDC	E531-16-PN3	25-216
1/4" - 5/2 - 24 VDC	E551-16-PN3	25-217
1/4" - 5/2 - 24 VDC	E551-16-P13	25-218
Elstyrd ventil exkl. elspole		
1/8" - 3/2	338-015-02	25-221
1/8" - 5/2	358-011-02	25-231
1/8" - 5/2	358-015-02	25-232
1/4" - 5/2	354-011-02	25-241
1/4" - 5/2	354-015-02	25-242
1/4" - 5/2	454-011-22	25-245
1/4" - 5/2	454-015-22	25-246
Elspole		
12 VDC / 24 VAC	U7H	25-271
24 VDC / 48 VAC	U77	25-272
230 / 240 VAC	U7J	25-273
Kabelkontakt		
15 mm	125-800	25-288
20 mm	122-800	25-283
20 mm lysdiod 24 V	122-701	25-281
20 mm lysdiod 230 V	122-703	25-282
26 mm	124-800	25-287
26 mm lysdiod 24 V	124-701	25-286



I.A.C. Komponenter AB
International Automation Components

P.O. Box 60, S-566 22 Habo • Phone: +46 (0)36 477 00 • Fax: +46 (0)36 477 15
E-mail: habo@iackomp.se • www.iackomp.se • Reg.No. 556461-2983

Pneumatikventiler

Pneumatiska ventiler och tillbehör

- Fabrikat: Camozzi
- Finns även i andra dimensioner och utföranden

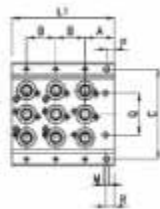

Dimension	Typnr.	Artikelnummer
Block Serie 3		
1/8" - 3/8"	CNVL-3H2	25-311
1/8" - 3/8"	CNVL-3H3	25-312
1/4" - 3/8"	CNVL-4H2	25-321
1/4" - 3/8"	CNVL-4H3	25-322
Gavelplatta Serie 3		
1/8" - 3/8"	CNVL-3H	25-310
1/4" - 3/8"	CNVL-4H	25-320
Blindplatta Serie 3		
1/8"	CNVL/1	25-305
1/4"	CNVL/4	25-306
Plugg blindplatta Serie 3		
1/8"	TCNVL/3	25-301
1/4"	TCNVL/5	25-302
Luftstyrd ventil		
1/8" - 3/2	338-033	26-021
1/8" - 3/2	338-035	26-022
1/8" - 5/2	358-033	26-031
1/8" - 5/2	358-035	26-032
1/4" - 5/2	354-033	26-041
1/4" - 5/2	354-035	26-042
1/4" - 5/2	454-33	26-045
1/4" - 5/2	454-35	26-046
1/2" - 5/2	452C-35	26-051
Mekaniskt styrd ventil		
M5 - 3/2	235-955	26-102
1/8" - 3/2	358-955	26-131
Basventil		
4 mmS - 3/2	234-000	26-201
M5 - 3/2	235-000	26-202
4 mmS - 5/3	284-000	26-203
Manöverorgan		
Tryck Röd (svamp)	200-895	26-205
Tryck Röd	200-975	26-206
Vred 2-läge	200-990	26-207
Vred 3-läge	200-870	26-208



I.A.C. Komponenter AB

International Automation Components

P.O. Box 60, S-566 22 Habo • Phone: +46 (0)36 477 00 • Fax: +46 (0)36 477 15

E-mail: habo@iackomp.se • www.iackomp.se • Reg.No. 556461-2983

Pneumatikventiler

Pneumatiska ventiler och tillbehör

- Fabrikat: Camozzi
- Finns även i andra dimensioner och utföranden

Dimension	Typnr.	Artikelnummer
Fotventil		
M5 - 3/2	235-925	26-216
1/4" - 5/2	354N-925	26-217
Handventil		
1/8" - 3/2	338-900	26-221
1/8" - 3/2	338-975	26-223
1/8" - 3/2	338-990	26-224
1/8" - 5/2	358-900	26-231
1/8" - 5/2	358-905	26-232
1/8" - 5/2	358-975	26-233
1/8" - 5/3	368-900	26-235
1/8" - 5/3	368-905	26-236
1/4" - 5/2	454-900	26-245
1/4" - 5/2	454-905	26-246
Handventil		
1/8" - 3/2	VMS-118	26-301
1/4" - 3/2	VMS-114	26-302
1/2" - 3/2	VMS-112	26-304
Växelventil		
1/8"	SCS-668-06	26-306
Strypbackventil		
M5 x 4 mmS	GSCU-814	26-311
1/8" x 6 mmS	GSCU-803	26-312
1/8" x 8 mmS	GSCU-804	26-313
1/4" x 10 mmS	GSCU-806	26-315
Strypljuddämpare		
1/8"	RSW	26-321
1/4"	RSW	26-322
M5	SCO 2905	26-325
1/8"	SCO 2905	26-326
1/4"	SCO 2905	26-327
Ljuddämpare Plan mässing		
M5		22-120
1/8" R		22-121
1/4" R		22-122
3/8" R		22-123
1/2" R		22-124
Ljuddämpare Konisk mässing		
1/8" R		22-126
1/4" R		22-127
3/8" R		22-128
1/2" R		22-129
Ljuddämpare för invändigt montage mässing		
1/8" R		22-131
1/4" R		22-132



I.A.C. Komponenter AB
International Automation Components

P.O. Box 60, S-566 22 Habo • Phone: +46 (0)36 477 00 • Fax: +46 (0)36 477 15
E-mail: habo@iackomp.se • www.iackomp.se • Reg.No. 556461-2983

Pneumatikventiler

Pneumatiska ventiler och tillbehör

- Fabrikat: Camozzi
- Finns även i andra dimensioner och utföranden



Dimension	Typnr.	Artikelnummer
-----------	--------	---------------

Backventil

1/8"	VNR-210	26-331
1/4"	VNR-843	26-332



Snabbavluftare

1/8"	VSC 588	26-341
1/4"	VSC 544	26-342
1/2"	VSC 522	26-343



Strypventil

1/8" inv.	2830	26-351
1/4" inv.	2830	26-352
3/8" inv.	2830	26-353
1/2" inv.	2830	26-354



I.A.C. Komponenter AB

International Automation Components

P.O. Box 60, S-566 22 Habo • Phone: +46 (0)36 477 00 • Fax: +46 (0)36 477 15

E-mail: habo@iackomp.se • www.iackomp.se • Reg.No. 556461-2983

Apparatskåp och transmitterlådor

- Fabrikat: Schramm • Tillverkas i glasfiberarmerad plast med utvändiga metalldelar i rostfritt stål • Anpassade för aggressiv miljö • Std. färg grå (RAL 7035) • Finns även i "Ex"-utförande och andra färger.

	Skrammnr. storlek HxBxD	Artikelnummer			
	Skåp typ PV Väggska	Skåp	Mont.plåt	Mont.sken	
Oisolerade skåp	PV 530 - 380 -240 -10	51-1311	51-3111	*	
	PV 600 - 500 -300 -10	51-1321	51-3121	*	
	10 – Enkeldörr fram	PV 600 - 500 -500 -10	51-1331	51-3121	*
		PV 600 -1000 -300 -20	51-1011	51-3011	*
	20 – Dubbdörr fram	PV 600 -1000 -500 -20	51-1031	51-3011	*
		PV 700 - 500 -300 -10	51-1401	51-3131	*
	PV 700 - 500 -500 -10	51-1411	51-3131	*	
	PV 750 - 750 -300 -10	51-1451	51-3151	*	
	PV 750 - 750 -400 -10	51-1471	51-3151	*	
	PV 800 -1000 -300 -20	51-1111	51-3031	*	
	PV 800 -1000 -500 -20	51-1131	51-3031	*	
	PV 1000 - 600 -300 -10	51-1021	51-3011	*	
	PV 1000 - 600 -500 -10	51-1041	51-3011	*	
	PV 1000 - 800 -300 -10	51-1121	51-3031	*	
	PV 1000 - 800 -500 -10	51-1141	51-3031	*	
	PV 1000 -1000 -300 -10	51-1221	51-3051	*	
	PV 1000 -1000 -500 -10	51-1241	51-3051	*	
	PV 1000 -1000 -300 -20	51-1211	51-3051	*	
	PV 1000 -1000 -500 -20	51-1231	51-3051	*	
	Standard – Oisolerade	P4.000 465-300-350	51-200	51-340	51-390
		P4.000 465-300-350 Fönster	51-203	51-340	51-390
		P4.001 565-425-370	51-201	51-3401	51-3901
		P4.001 565-425-370 Fönster	*	51-3401	51-3901
P4.100 450-450-475		51-210	51-341	51-391	
P4.110 450-450-310		51-211	"	"	
P4.100 450-450-475 Isolerad		51-215	"	"	
P4.110 450-450-310 Isolerad		51-216	"	"	
P4.200 600-450-475		51-220	51-342	51-392	
P4.210 600-450-310		51-221	"	"	
P4.200 600-450-475 Isolerad		51-225	"	"	
P4.210 600-450-310 Isolerad		51-226	"	"	
P4.300 700-500-475		51-230	51-343	51-393	
P4.310 700-500-310		51-231	"	"	
P4.300 700-500-475 Isolerad		51-235	"	"	
P4.310 700-500-310 Isolerad		51-236	"	"	
P4.320 700-500-475 Fönster	*	*	*		

* mot order

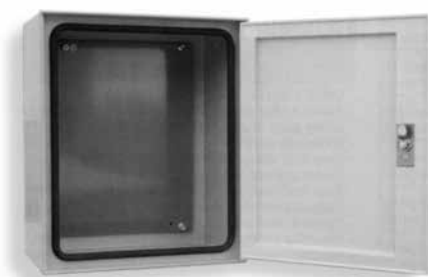

-PV



-P4

Apparatskåp och transmitterlådor

- Fabrikat: Schramm • Tillverkas i glasfiberarmerad plast med utvändiga metalldelar i rostfritt stål • Anpassade för aggressiv miljö • Std. färg grå (RAL 7035) • Finns även i "Ex"-utförande och andra färger.

Standard – Oisolerade

Skåpnr. storlek HxBxD	Artikelnummer		
Skåp typ P4 Transmitterlådor	Skåp	Mont.plåt	Mont.sken
P4.600 500-466-400	51-240	51-344	*
P4.610 500-591-400	51-241	51-345	*
P4.620 500-716-400	51-242	51-346	*
P4.600 500-466-400 Isolerad	51-245	51-344	*
P4.610 500-591-400 Isolerad	51-246	51-345	*
P4.620 500-716-400 Isolerad	51-247	51-346	*

* mot order

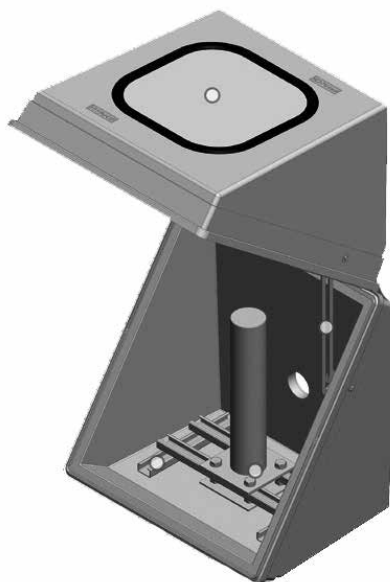

-P4.600

Apparatskåp och gasflaskeskåp

- Fabrikat: Schramm • Tillverkas i glasfiberarmerad plast med utvändiga metalldelar i rostfritt stål • Anpassade för aggressiv miljö • Std. färg grå (RAL 7035) • Finns även i "Ex"-utförande och andra färger • Gasflaskeskåp finns även i plåt.

Schramnr. storlek HxBxD

Artikelnummer

Isolerade skåp

- 10 – Enkeldörr fram
- 20 – Dubbdörr fram

Standard utrustning

- Färg: RAL 7035 gråton
- Spanjolettlås
- 20 mm vägg tjocklek med PU-isolering
- Genomgående monteringsbussningar M10 i rostfritt stål
- Skåpen kan levereras med montageplåt eller skenor

Skåp typ KS Väggskaap/Golvskåp

Skåp

Mont.plåt

Vikt

KS 600 -1000 -300 -20	51-154	51-3011	22 kg
KS 600 -1000 -500-20	51-155	51-3011	25 kg
KS 700 - 500 -300 -10	51-157	51-3131	15 kg
KS 700 - 500 -500 -10	51-158	51-3131	17 kg
KS 750 - 750 -300 -10	51-161	51-3151	20 kg
KS 750 - 750 -400 -10	51-162	51-3151	22 kg
KS 800 -1000 -300 -20	51-165	51-3031	25 kg
KS 800 -1000 -500 -20	51-166	51-3031	29 kg
KS 1000 - 600 -300 -10	51-171	51-3011	21 kg
KS 1000 - 600 -500 -10	51-172	51-3011	24 kg
KS 1000 - 800 -300 -10	51-173	51-3031	24 kg
KS 1000 - 800 -500 -10	51-174	51-3031	28 kg
KS 1000 -1000 -300 -10	51-176	51-3051	28 kg
KS 1000 -1000 -500 -10	51-177	51-3051	32 kg
KS 1000 -1000 -300 -20	51-178	51-3051	29 kg
KS 1000 -1000 -500 -20	51-179	51-3051	33 kg
KS 1100 -1100 -500 -10	*	*	41 kg
KS 1100 -1100 -600 -10	*	*	48 kg
KS 2060 - 900 -500 -10	*	*	60 kg
KS 2060 - 900 -600 -10	*	*	70 kg

- P - oisolerad
- PS - isolerad

De flesta skåpstyper och storlekar går även att erhållas i lackad stålplåt eller rostfri plåt.

Skåp typ FS-PS Gasflaskeskåp

Vikt

Antal gasflaskor

FG-P 450 - 660 -310	9 kg	1 st
FS-PS 2065 -1000 -500-10	70 kg	3 st
FS-PS 2065 -1200 -500-10	90 kg	4 st
FS-PS 2065 -1500 -500-20	100 kg	5 st
FS-PS 2065 -2000 -500-20	123 kg	7 st

Oisolerade skåp

Skåp typ FS-ST Stålplåt

Vikt

Antal gasflaskor

FS-ST 2050 - 640 -400-10	81 kg	2 st
FS-ST 2050 - 940 -400-20	98 kg	3 st
FS-ST 2050 -1240 -400-20	132 kg	4 st
FS-ST 2050 -1540 -400-20	164 kg	5 st
FS-ST 2050 -1840 -400-30	193 kg	6 st
FS-ST 2050 -2140 -400-30	217 kg	7 st
FS-ST 2050 -2440 -400-40	250 kg	8 st



-KS



-FG-P

-FS-PS



-FS-ST

Apparatskåp

- Fabrikat: Schramm • Tillverkas i glasfiberarmerad plast med utvändiga metalldelar i rostfritt stål • Anpassade för aggressiv miljö • Std. färg grå (RAL 7032) • Finns även i "Ex"-utförande och andra färger.

Schrammnr. storlek HxBxD

Isolerade skåp

E01: Höjd – 1190 mm

E02: Höjd – 2140 mm

* Finns med flera olika dörr-alternativ:

10 – Enkel-dörr fram

11 – Enkel-dörr fram och bak

20 – Dubbel-dörr fram

22 – Dubbel-dörr fram och bak

10+10 – 2 enkeldörrar fram

11+11 – 2 enkeldörrar fram och bak

Skåp typ E Golvska

Vikt

E 01 -1000 - 500 -*	61 kg
E 01 -1000 - 600 -*	67 kg
E 01 -1000 -1000 -*	90 kg
E 01 -1200 - 500 -*	70 kg
E 01 -1200 - 600 -*	77 kg
E 01 -1200 -1000 -*	105 kg
E 01 -1500 - 500 -*	90 kg
E 01 -1500 - 600 -*	99 kg
E 01 -1500 -1000 -*	134 kg
E 01 -2000 - 500 -*	106 kg
E 01 -2000 - 600 -*	115 kg
E 01 -2000 -1000 -*	183 kg
E 02 -1000 - 500 -*	90 kg
E 02 -1000 - 600 -*	98 kg
E 02 -1000 -1000 -*	128 kg
E 02 -1200 - 500 -*	103 kg
E 02 -1200 - 600 -*	111 kg
E 02 -1200 -1000 -*	148 kg
E 02 -1500 - 500 -*	122 kg
E 02 -1500 - 600 -*	132 kg
E 02 -1500 -1000 -*	180 kg
E 02 -2000 - 500 -*	154 kg
E 02 -2000 - 600 -*	165 kg
E 02 -2000 -1000 -*	240 kg

Standard utrustning

- Färg: RAL 7035 gråton
- Spanjolettlås
- 20 mm vägg tjocklek med PU-isolering
- Alla väggsektioner är hopmonterade med M10 bult av rostfritt stål
- Takutsprång på 50 mm
- Skåpen kan levereras med montageplåt eller skenor

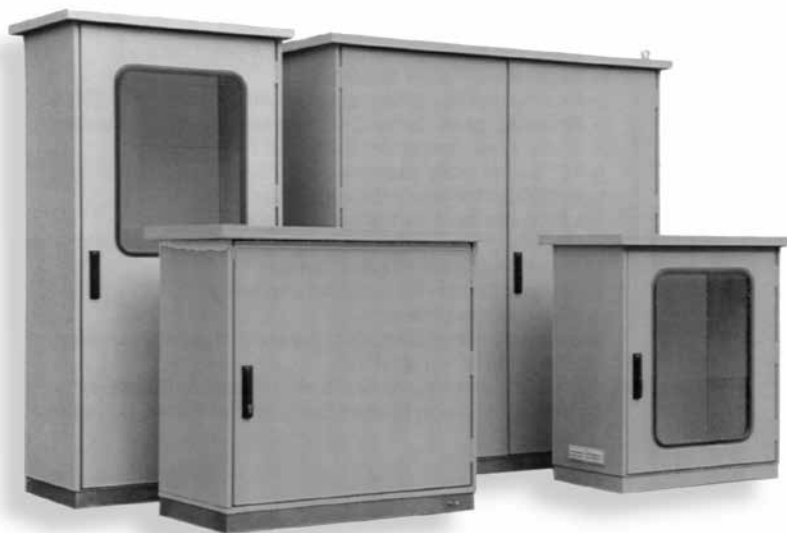

-E01, E02

Apparatskåp

- Fabrikat: IAC • Tillverkas i rostfritt stål SIS 2333
- Godstjocklek 1,5mm i skåp och dörr. Inkl. montageplåt, godstjocklek 2mm.
- Enkelt att ändra från höger till vänsterhängning



Storlek HxBxD

Artikelnummer

Skåp typ RF Väggsåkåp IP55

RF	300x250x150, m.plåt.	251x201	52-052	6,4 kg
RF	300x250x200, m.plåt.	251x201	52-053	7,0 kg
RF	300x300x150, m.plåt.	251x251	52-054	7,0 kg
RF	350x250x150, m.plåt.	301x201	52-055	7,0 kg
RF	350x250x200, m.plåt.	301x201	52-056	8,0 kg
RF	400x300x150, m.plåt.	351x251	52-057	9,6 kg
RF	400x300x200, m.plåt.	351x251	52-058	9,9 kg
RF	400x400x200, m.plåt.	351x351	52-059	10,5 kg
RF	500x300x200, m.plåt.	451x251	52-061	11,4 kg
RF	500x350x200, m.plåt.	451x301	52-063	12,8 kg
RF	500x400x250, m.plåt.	451x351	52-065	15,9 kg
RF	600x400x200, m.plåt.	551x351	52-067	17,0 kg
RF	600x400x250, m.plåt.	551x351	52-068	19,1 kg
RF	700x500x250, m.plåt.	651x451	52-072	24,5 kg
RF	800x500x250, m.plåt.	751x451	52-074	28,0 kg
RF	800x600x250, m.plåt.	751x551	52-076	30,8 kg
RF	800x600x300, m.plåt.	751x551	52-077	32,5 kg
RF	900x600x250, m.plåt.	851x551	52-079	34,7 kg
RF	1000x800x250, m.plåt.	951x751	52-084	46,0 kg
RF	1200x800x250, m.plåt.	1151x751	52-087	55,4 kg

Tillbehör Väggsåkåp

Nyckellås med vred	52-093
Väggfäste 4st 2333	52-095



I.A.C. Komponenter AB

International Automation Components

P.O. Box 60, S-566 22 Habo • Phone: +46 (0)36 477 00 • Fax: +46 (0)36 477 15

E-mail: habo@iackomp.se • www.iackomp.se • Reg.No. 556461-2983

Tillbehör

• Fabrikat: Schramm där inget annat anges.

Skåptillbehör

Artikelnummer

Värmeelement Std. inkl. termostat för elvärmare

SKH Elvärmare 250W/230V	51-401
SKH Elvärmare 500W/230V	51-402
H1 Ånga/Vattenvärmare	*
H2 Ånga/Vattenvärmare	*

Värmeelement "EX" inkl. termostat TS16 +20°C

EHR H T4 200W/230V	51-421
EHR H T3 200W/230V	51-422
EHR H T4 300W/230V	51-423
EHR H T3 300W/230V	51-424
EHR H T3 500W/230V	51-425
EHR V T4 500W/230V	51-426
EHR V T3 500W/230V	51-427
EHR V T3 750W/230V	51-428
EHR V T3 1000W/230V	51-429

Termostat "EX"

TS 16 T4 +10°C	51-414
TS 16 T4 +20°C	51-415
TS 16 T4 +30°C	51-416
TS 16 T3 +10°C	51-417
TS 16 T3 +20°C	51-418
TS 16 T3 +30°C	51-419
ETR 5/80 +5°C – +80°C	51-4131

Värmeplatta "EX"

EHP 200 T4 200W/230V	51-435
EHP 200 R T4 200W/230V (med hölje)	51-436

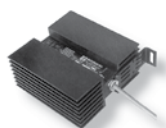

Tillbehör

• Fabrikat: Schramm där inget annat anges.

Skåptillbehör

Artikelnummer



Ryggfäste "IAC" rostfri 2333	Schramm	Sarel	Rittal
L= 290 Till 1423	—	—	57-060
L= 340 Till 9016, 1432	—	57-061	57-061
L= 390 Till 1434	—	—	57-062
L= 430 Till PV 530, P4.1xx	57-067	—	—
L= 550 Till P4.2xx	57-070	—	—
L= 590 Till PV 600, 9025, 1446	57-064	57-064	57-064
L= 670 Till PV 700, 750, P4.3xx	57-068	—	—
L= 780 Till PV 800, 1468	57-066	—	57-066
L= 990 Till PV 1000, 1480	57-069	—	57-069

Tillbehör

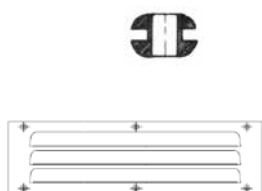

Gummigenomföring 6 mm	51-495
Gummigenomföring 12 mm	51-496
Ventillationsgaller utsida typ 1	51-491
Ventillationsgaller insida typ 2	51-492
Isolerskiva 500 x 1000 x 20 mm	57-200
Låshandtag med nyckel 0500	51-400
Låshandtag utan nyckel 0502	51-399
T-handtag med nyckel 0506	51-396
T-handtag utan nyckel 0505	51-395
Vridlås med 3 mm spårtapp 0509	51-3943
Vridlås med nyckel 0510	51-394
Paniklås med låscylinde 0513	51-3961
Vridhandtag utan låscylinde 0523	51-3962
Låscylinde till vridhandtag 0523	51-3965
Snäplås kompl. för P4	51-397
Gångjärn kompl. för P4	51-398

* mot order

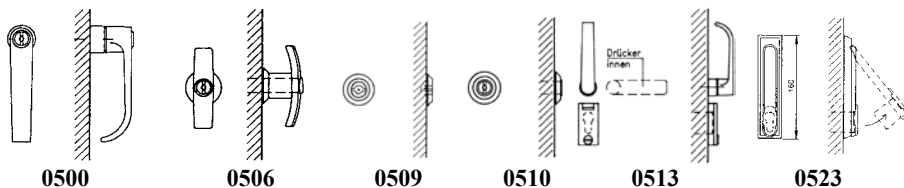

Bodar

- Fabrikat: Schramm • Bodarna går även att erhålla i lackad stålplåt eller rostfri plåt och i andra utföranden.

Serie ESK

SCHRAMM-bodarnas moduler har utvecklats efter lång erfarenhet från skåpskonstruktion. Bodarna kan byggas på många olika sätt. Bredd, djup och höjd bestäms i förväg. Många grundvarianter kan anpassas efter kundens egna behov och önskemål. Då golvet, väggarna och taket är hopsatt av moduler finns möjligheten att montera boden på plats och att utvidga eller byta ut enstaka sektioner.



ESK-20

Som en speciell fördel har modell ESK-80 en väggjocklek på 80 mm och en isolerad golvbass vilket garanterar ett optimalt isoleringsvärde av $k=0,35 \text{ W/m}^2 \text{ K}$.

Dörrhalvorna är utrustade med ram och gångjärn av rostfritt stål, vilka är lackerade i bodens egna färger. Dörren har en öppningsradie av 180° . För att garantera IP65 (för enkeldörrar) och IP54 (för dubbel-dörrar) är de tätade med en högkvalitativ kantlist av gummi.

Samtliga väggar har gängade M10-bussningar för montering av hållare och instrument på olika sätt. Bussningen är tillverkad för att tåla höga belastningar.

ESK-serien är en självbärande konstruktion, det behövs därför inget extra stöd. Samtliga väggar, golv och taksektioner är av sandwichkonstruktion fyllda med PU-skum för extra stabilitet och bättre isolering. Varje sektion är hermetiskt tillslutet. Utmärkt isolering mot höga och låga temperaturer, korrosions- och saltvattenbeständigt. Alla vägg och dörrsektioner är hopmonterade. En stabil golvsockel, av rostfritt stål, avsedd för att tåla höga mekaniska belastningar, bär upp boden. Olika typer av golvutförande finns att erhålla efter önskemål.



ESK-80

Bodar

- Fabrikat: Schramm • Bodarna går även att erhålla i lackad stålplåt eller rostfri plåt och i andra utföranden.

Serie ESK

Tak

- Sandwichkonstruktion (PU-skum)
- Gångbart tak, hög mekanisk stabilitet
- Utförande anpassat efter väggsektionens bredd, 500 mm och 1000 mm
- Spännvidd upp till 4100 mm

Golv

Golvkonstruktionen finns tillgänglig i olika varianter.

De separata variationerna är anpassade för industriella önskemål

- Ram i rostfri U-profil 80 mm ESK-20 (ESK-80 100 mm)
- Standard utförande med endast golvram
- Med golv av räfflade aluminiumplattor isolerade med PU-skum
- Med golv av räfflade aluminiumplattor isolerade med stenull och undergolv i aluminium
- Går även erhålla med golv av rostfritt stål

Bodens höjd

<i>Utförande</i>	<i>Väggsektionens höjd</i>	<i>Bodens höjd utan/med golv</i>
ESK-20	2020 mm	2140/2145 mm
ESK-20	2420 mm	2540/2545 mm
ESK-20	2820 mm	2940/2945 mm
ESK-80	2420 mm	2600/2605 mm
ESK-80	2820 mm	3000/3005 mm



Bodar

- Fabrikat: Schramm • Bodarna går även att erhålla i lackad stålplåt eller rostfri plåt och i andra utföranden.

Dimensioner

A - Mittsektion ESK-20

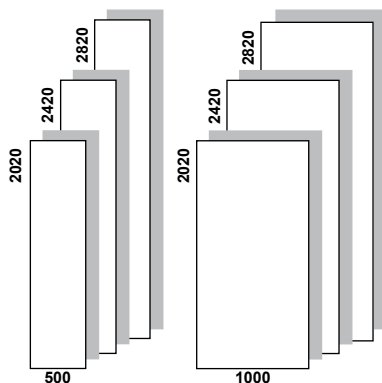

Bredd: 500 mm, 1000 mm

Höjd: 2020 mm, 2420 mm, 2820 mm

Storlek och höjd på boden tillverkas enligt önskemål.

B - Hörnsektion ESK-20

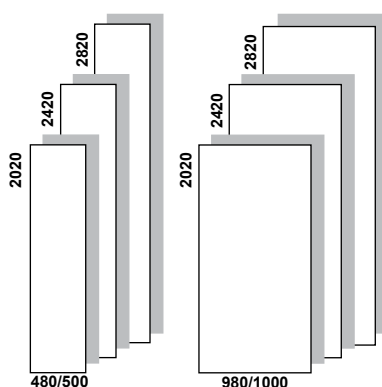

Bredd: 480/500 mm, 980/1000 mm

Höjd: 2020 mm, 2420 mm, 2820 mm

Hörnsektionen kombineras med en mittsektion till varje hörn.

C - Dörrsektion ESK-20

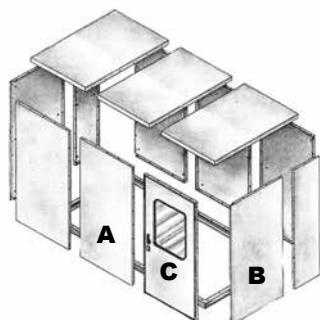
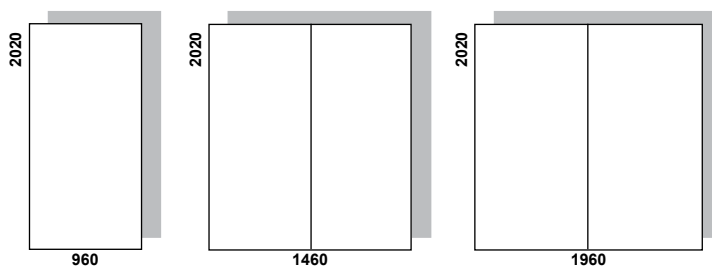

Dörr:	1000 mm	1500 mm	2000 mm
<i>Innermått:</i>			
Bredd:	880 mm	1380 mm	1880 mm
Höjd:	1940 mm	1940 mm	1940 mm

Bodar

- Fabrikat: Schramm • Bodarna går även att erhålla i lackad stålplåt eller rostfri plåt och i andra utföranden.

Utförande

Standard

- Färg: RAL 7035 gråton
- Alla väggsektioner är hopmonterade med M10 bult av rostfritt stål
- Takutsprång på 50 mm

Modell ESK-20:

- Vägg och dörrsektioner tjocklek 20 mm
- Taksektioner tjocklek 40 mm
- Isolervärde $k=1,2 \text{ W/m}^2 \text{ K}$
- Spanjolettlås med låscylinder (låstyp nr. 0513)
- Utan golv med bottenram i rostfritt stål 50 x 80 x 80 x 2,5

Modell ESK-80:

- Vägg, dörr och taksektioner tjocklek 80 mm
- Isolervärde $k=0,35 \text{ W/m}^2 \text{ K}$
- Lås med handtrycke
- Golv av aluminium durkplåt med bottenram i rostfritt stål 100 x 100 x 100 x 3

Montageplåt, skenor

- Stålplåt, 2,5 mm tjock, kantbockad
- För väggelement 480/ 500 mm: B= 400, H= 1930 mm
- För väggelement 980/1000 mm: B= 900, H= 1930 mm
- Andra storlekar och material vid förfrågan
- Montageskenor C-profil

Extra utrustning

- "Ex" utförande med ytmotstånd enl. DIN 50014 ($< 10^9 \Omega$)
- Gummilistförsedda observationsfönster i laminerat säkerhetsglas eller akrylglas i dörr och väggsektioner
- Andra låsvarianter
- Dörrstopp med gasfjäder
- Uppvärmning med varmvatten och ånga
- Elvärme standard eller "Ex" utförande
- Ventilationssystem
- Monteringsplåtar
- Monteringskenor C-profil
- Belysning, ventilationskanaler, luftkonditionering och annan utrustning kan installeras om så önskas
- Öglor för lyftning, för normal och tung viktkapacitet
- Transport- och monteringsfästen i golvsockeln
- Andra golvvarianter
- Bredare droptak (taköverhäng)
- Sektioner i brandklass F30 eller B1-DIN 4102
- Andra höjder och utförande
- Sluss och överbyggd entré
- Integrerad gasflaskeskåp

Kulventiler

- Kulventiler i förnicklad mässing och syrafast stål 316 - 2343.
- Utv. gänga KR (BSPT) - Europeisk konisk rörgänga
- Inv. gänga R (BSPP) - Europeisk cylindrisk rörgänga
- NPT - Amerikansk konisk rörgänga

Dimension	Typnr.	Artikelnummer
	Kulventil PN10 förnicklad mässing	BSP
1/4" utv. x inv.		61-001
3/8" utv. x inv.		61-002
1/2" utv. x inv.		61-003
	Kulventil PN10 förnicklad mässing	BSP
1/4" inv.		61-006
3/8" inv.		61-007
1/2" inv.		61-008
	Kulventil Mini PN10 förnicklad mässing	BSP
1/8" utv. x inv.		61-020
1/4" utv. x inv.		61-021
	Kulventil Mini PN56 syrafast	BSPP
1/4" inv.		61-1502
	Kulventil PN63 fullflöde syrafast	BSPP
1/4" inv.		61-1501
3/8" inv.		61-1511
1/2" inv.		61-1521
3/4" inv.		61-1531
1" inv.		61-1541
1 1/4" inv.		61-1551
1 1/2" inv.		61-1561
	Kulventil PN63 med avluftning fullflöde syrafast	BSPP
1/4" inv.		61-170
3/8" inv.		61-171
1/2" inv.		61-172
	Kulventil PN 200 Safelok syrafast	NPT
1/4" inv.	BV2N-SS	61-655
3/8" inv.	BV3N-SS	61-656
1/2" inv.	BV4N-SS	61-657
	Kulventil 3-vägs PN65 syrafast	BSPP
1/2" inv. "L"-port		61-162
1/4" inv. "T"-port		61-165
1/2" inv. "T"-port		61-167

Tryck- och temperaturdiagram för Kulventil PN63

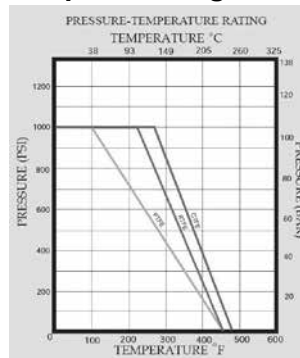

I.A.C. Komponenter AB

International Automation Components

P.O. Box 60, S-566 22 Habo • Phone: +46 (0)36 477 00 • Fax: +46 (0)36 477 15

E-mail: habo@iackomp.se • www.iackomp.se • Reg.No. 556461-2983



Kulventiler

Kulventiler

• Fabrikat: Alco • Syrafast stål 316 - 2343 • Industriventiler med hög kvalitet • De flesta varianter finns i storlekar upp till 2 1/2" och tillverkas även i andra material • Alla ventiler går att erhålla med NPT-, BSPP- eller BSPT-rörgångor.



Dimension	Typnr.	Artikelnummer	
Kulventil Mini PN50 "A"-serien			
		NPT	BSPP
1/4" inv.	MA2xS	61-301	61-300
1/4" utv. x inv.	MA2xS-LM	61-304	61-303
Kulventil Barstock PN50 "A"-serien			
		NPT	BSPP
1/4" inv.	A2xS	*	*
3/8" inv.	A3xS-LM	61-312	61-311
1/2" inv.	A4xS-LM	61-317	61-316
3/4" inv.	A6xS	*	*
1" inv.	A8xS	*	*
Kulventil Barstock PN130 "A"-serien			
1/4" inv.	RA2xS	*	
3/8" inv.	RA3xS-LM	*	
1/2" inv.	RA4xS-LM	*	
3/4" inv.	RA6xS	*	
1" inv.	RA8xS	*	
Kulventil Barstock PN64 "B"-serien			
1/4" inv.	B2xS	*	
3/8" inv.	B3xS	*	
1/2" inv.	B4xS	*	
3/4" inv.	B6xS	*	
1" inv.	B8xS	*	
Kulventil Barstock PN130 "B"-serien			
1/4" inv.	RB2xS	*	
3/8" inv.	RB3xS	*	
1/2" inv.	RB4xS	*	
3/4" inv.	RB6xS	*	
1" inv.	RB8xS	*	
Kulventil Barstock PN200 "B"-serien			
1/4" inv.	HB2xS	*	
3/8" inv.	HB3xS	*	
1/2" inv.	HB4xS	*	
3/4" inv.	HB6xS	*	
1" inv.	HB8xS	*	
Kulventil Barstock PN400 "B"-serien			
1/4" inv.	PB2xS	*	
3/8" inv.	PB3xS	*	
1/2" inv.	PB4xS	*	
3/4" inv.	PB6xS	*	
1" inv.	PB8xS	*	
Kulventil för panelmontering PN64			
1/4" inv.	SB2xS	*	
3/8" inv.	SB3xS	*	
1/2" inv.	SB4xS	*	
3/4" inv.	SB6xS	*	
1" inv.	SB8xS	*	

* mot order



I.A.C. Komponenter AB

International Automation Components

P.O. Box 60, S-566 22 Habo • Phone: +46 (0)36 477 00 • Fax: +46 (0)36 477 15

E-mail: habo@iackomp.se • www.iackomp.se • Reg.No. 556461-2983



Kulventiler

Kulventiler

• Fabrikat: Alco • Syrafast stål 316 - 2343 • Industriventiler med hög kvalitet • De flesta varianter finns i storlekar upp till 2 1/2" och tillverkas även i andra material • Alla ventiler går att erhålla med NPT-, BSPP- eller BSPT-rörgångor.



Dimension	Typnr.	Artikelnummer
-----------	--------	---------------

Kulventil för panelmontering PN 130

1/4" inv.	RSB2xS	*
3/8" inv.	RSB3xS	*
1/2" inv.	RSB4xS	*
3/4" inv.	RSB6xS	*
1" inv.	RSB8xS	*

Kulventil för panelmontering PN 200

1/4" inv.	HSB2xS	*
3/8" inv.	HSB3xS	*
1/2" inv.	HSB4xS	*
3/4" inv.	HSB6xS	*
1" inv.	HSB8xS	*

Kulventil för panelmontering PN 400

1/4" inv.	PSB2xS	*
3/8" inv.	PSB3xS	*
1/2" inv.	PSB4xS	*
3/4" inv.	PSB6xS	*
1" inv.	PSB8xS	*



Kulventil för panelmontering PN 64

1/4" inv.	SN2xS	*
3/8" inv.	SN3xS	*
1/2" inv.	SN4xS	*

Kulventil för panelmontering PN 200

1/4" inv.	HSN2xS	*
3/8" inv.	HSN3xS	*
1/2" inv.	HSN4xS	*

Kulventil för panelmontering PN 400

1/4" inv.	PSN2xS	*
3/8" inv.	PSN3xS	*
1/2" inv.	PSN4xS	*

Kulventil för panelmontering PN 670

1/4" inv.	USN2xS	*
3/8" inv.	USN3xS	*
1/2" inv.	USN4xS	*



Kulventil med klämringskopplingar PN64 "B"-serien

6 mm YD	B2xCS	*
8 mm YD	B3xCS	*
10 mm YD	B4xCS	*
12 mm YD	B6xCS	*

Kulventil med klämringskopplingar PN130 "B"-serien

6 mm YD	RB2xCS	*
8 mm YD	RB3xCS	*
10 mm YD	RB4xCS	*
12 mm YD	RB6xCS	*

* mot order



I.A.C. Komponenter AB

International Automation Components

P.O. Box 60, S-566 22 Habo • Phone: +46 (0)36 477 00 • Fax: +46 (0)36 477 15

E-mail: habo@iackomp.se • www.iackomp.se • Reg.No. 556461-2983



Kulventiler

Kulventiler

- Fabrikat: Alco • Syrafast stål 316 - 2343 • Industriventiler med hög kvalitet • De flesta varianter finns i storlekar upp till 2 1/2" och tillverkas även i andra material • Alla ventiler går att erhalla med NPT-, BSPP- eller BSPT-rörgångor.



Dimension	Typnr.	Artikelnummer
-----------	--------	---------------

Kulventil med klämringskopplingar PN200 "B"-serien		
--	--	--

6 mm YD	HB2xCS	*
8 mm YD	HB3xCS	*
10 mm YD	HB4xCS	*
12 mm YD	HB6xCS	*

Kulventil med klämringskopplingar PN400 "B"-serien		
--	--	--

6 mm YD	PB2xCS	*
8 mm YD	PB3xCS	*
10 mm YD	PB4xCS	*
12 mm YD	PB6xCS	*



Kulventil 3-vägs "L"-port PN64		
--------------------------------	--	--

1/4" inv.	SB2xS-3L	*
3/8" inv.	SB3xS-3L	*
1/2" inv.	SB4xS-3L	*
3/4" inv.	SB6xS-3L	*
1" inv.	SB8xS-3L	*



Kulventil 3-vägs "B"-port PN64		
--------------------------------	--	--

1/4" inv.	SB2xS-3B	*
3/8" inv.	SB3xS-3B	*
1/2" inv.	SB4xS-3B	*
3/4" inv.	SB6xS-3B	*
1" inv.	SB8xS-3B	*

Kulventil 3-vägs "L"-port PN200		
---------------------------------	--	--

1/4" inv.	HSB2xS-3L	*
3/8" inv.	HSB3xS-3L	*
1/2" inv.	HSB4xS-3L	*
3/4" inv.	HSB6xS-3L	*
1" inv.	HSB8xS-3L	*

Kulventil 3-vägs "B"-port PN200		
---------------------------------	--	--

1/4" inv.	HSB2xS-3B	*
3/8" inv.	HSB3xS-3B	*
1/2" inv.	HSB4xS-3B	*
3/4" inv.	HSB6xS-3B	*
1" inv.	HSB8xS-3B	*

Kulventil 3-vägs "L"-port PN400		
---------------------------------	--	--

1/4" inv.	PSB2xS-3L	*
3/8" inv.	PSB3xS-3L	*
1/2" inv.	PSB4xS-3L	*
3/4" inv.	PSB6xS-3L	*
1" inv.	PSB8xS-3L	*

Kulventil 3-vägs "B"-port PN400		
---------------------------------	--	--

1/4" inv.	PSB2xS-3B	*
3/8" inv.	PSB3xS-3B	*
1/2" inv.	PSB4xS-3B	*
3/4" inv.	PSB6xS-3B	*
1" inv.	PSB8xS-3B	*

* mot order



I.A.C. Komponenter AB

International Automation Components

P.O. Box 60, S-566 22 Habo • Phone: +46 (0)36 477 00 • Fax: +46 (0)36 477 15
E-mail: habo@iackomp.se • www.iackomp.se • Reg.No. 556461-2983



Kulventiler

Kulventiler

- Fabrikat: Alco • Syrafast stål 316 - 2343 • Industriventiler med hög kvalitet • De flesta varianter finns i storlekar upp till 2 1/2" och tillverkas även i andra material • Alla ventiler går att erhålla med NPT-, BSPP- eller BSPT-rörgångor.



Dimension	Typnr.	Artikelnummer
-----------	--------	---------------

Kulventil 4-vägs PN64

1/4" inv.	SB2xS-x4	*
3/8" inv.	SB3xS-x4	*
1/2" inv.	SB4xS-x4	*
3/4" inv.	SB6xS-x4	*
1" inv.	SB8xS-x4	*

Kulventil 4-vägs PN200

1/4" inv.	HSB2xS-x4	*
3/8" inv.	HSB3xS-x4	*
1/2" inv.	HSB4xS-x4	*
3/4" inv.	HSB6xS-x4	*
1" inv.	HSB8xS-x4	*

Kulventil 4-vägs PN400

1/4" inv.	PSB2xS-x4	*
3/8" inv.	PSB3xS-x4	*
1/2" inv.	PSB4xS-x4	*
3/4" inv.	PSB6xS-x4	*
1" inv.	PSB8xS-x4	*



Manometerkulventil PN64

1/4" inv.	32FxS	*
1/4" inv. x utv.	32MxS	*
1/2" inv.	34FxS	*
1/2" inv. x utv.	34MxS	*

Manometerkulventil PN200

1/4" inv.	H32FxS	*
1/4" inv. x utv.	H32MxS	*
1/2" inv.	H34FxS	*
1/2" inv. x utv.	H34MxS	*

Manometerkulventil PN400

1/4" inv.	P32FxS	*
1/4" inv. x utv.	P32MxS	*
1/2" inv.	P34FxS	*
1/2" inv. x utv.	P34MxS	*



Kulventil Sandwich PN100 "S"-serien

Dimension	Typnr.	BSPP
1/4" inv.	S2xS	*
3/8" inv.	S3xS	61-372
1/2" inv.	S4xS	61-373
3/4" inv.	S6xS	*
1" inv.	S8xS	*

Kulventil Sandwich PN200 "S"-serien

1/4" inv.	HS2xS	*
3/8" inv.	HS3xS	*
1/2" inv.	HS4xS	*
3/4" inv.	HS6xS	*
1" inv.	HS8xS	*

* mot order



I.A.C. Komponenter AB

International Automation Components

P.O. Box 60, S-566 22 Habo • Phone: +46 (0)36 477 00 • Fax: +46 (0)36 477 15

E-mail: habo@iackomp.se • www.iackomp.se • Reg.No. 556461-2983

Nålventiler

- Fabrikat: Safelok • Syrafast stål 316 - 2343
- Går även att erhålla med BSPP eller BSPT-gänga.

Dimension	Typnr.	Artikelnummer
Nålventil PN 400		
NPT		
1/4" inv.	IV2N-SS	61-602
3/8" inv.	IV3N-SS	61-603
1/2" inv.	IV4N-SS	61-604
1/4" inv. x utv.	IV2NMF-SS	61-607
3/8" inv. x utv.	IV3NMF-SS	61-608
1/2" inv. x utv.	IV4NMF-SS	61-609
Nålventil PN 400 med klämringsskopplingar		
6 mm YD	IV6MC2S	61-616
12 mm YD	IV12MC2S	61-619
Nålventil PN 400 med muffsvets (Socket Weld)		
12 mm SW	IV12mSWS-6-GP-ST	61-624
Nålventil PN 400 med muffsvets & svetsstuds 20 mm		
12 mm SW		61-634
12 mm SW x 1/2" NPT		61-638
Manometerventil PN 400		
NPT		
1/2" inv. x utv.	IVMG4N-SS+VBP2N	61-648
Manometeradapter vridbar, 2-delad		
1/2" inv. BSPP x 1/2" utv. NPT		61-198
Manometeradapter vridbar, 3-delad		
1/2" inv. BSPP x 1/2" utv. NPT		61-6492
Manometernippel		
1/2" inv. BSPP x 3/8" utv. BSPP		61-183
1/2" utv. BSPP x 1/2" inv. NPT		61-195
1/2" utv. BSPP x 1/2" utv. NPT		61-192
Manometermutter		
3/8" inv. BSPP höger/vänster gänga		61-188
1/2" inv. BSPP höger/vänster gänga		61-189



I.A.C. Komponenter AB
International Automation Components

P.O. Box 60, S-566 22 Habo • Phone: +46 (0)36 477 00 • Fax: +46 (0)36 477 15
E-mail: habo@iackomp.se • www.iackomp.se • Reg.No. 556461-2983

Nålventiler

- Fabrikat: Safelok • Syrafast stål 316 - 2343
- Går även att erhålla med BSPP eller BSPT-gänga.

Dimension	Typnr.	Artikelnummer
Avluftningsventil		
NPT		
1/4" utv.	VP2N-SS	61-640
1/2" utv.	VP4N-SS	61-642
Backventil PN 400		
NPT		
1/4"	CV2N-SS	61-671
1/2"	CV4N-SS	61-673
6 mm YD	CV6mC2-SS	61-675
12 mm YD	CV12mC2-SS	61-678
Manometerventil PN400 med fläns		
BSPP		
3/8"		61-256
1/2"		61-257
Testuttag/Tryckprovare		
Testuttag/tryckprovare till manometerventil med fläns, diameter 40mm. 1/4" anslutning. Max 300 bar.		62-010
O-ring till testuttag		62-011
Testplatta 1/4" utv. SF		62-020
Testplatta 1/4" NPT utv. SF		62-021
Testplatta M20x1,5mm inv. SF		62-022
Testplatta 8mm Rör L-100mm vinkel SF		62-023



I.A.C. Komponenter AB
International Automation Components

P.O. Box 60, S-566 22 Habo • Phone: +46 (0)36 477 00 • Fax: +46 (0)36 477 15
E-mail: habo@iackomp.se • www.iackomp.se • Reg.No. 556461-2983

Ventilblock

- Fabrikat: Safelok • Syrafast stål 316 - 2343
- Går även att erhålla med BSPP eller BSPT-gänga.



Dimension	Typnr.	Artikelnummer
Ventilblock 2-vägs PN 400		
1/2" inv. NPT	IV2R4N-A-SS	65-257
1/2" inv. NPT x 1/2" inv. BSPP	IV2R4NP-A-SS	65-259
Ventilblock 2-vägs PN 400		
		NPT
1/2" inv.	IV2R4N-B-SS	65-255
Ventilblock 2-vägs PN 400		
		NPT
1/2" inv. x direktfläns	IVM2D4N-A-SS	65-251
Ventilblock 2-vägs PN 400		
		NPT
1/2" inv. x utv.	IV2GM4N-SS	65-248
Ventilblock 2-vägs PN 400 med swivel		
1/2" utv. NPT x 1/2" inv. BSPP	IV2GM4N-4PSWF-SS	65-246
Ventilblock 3-vägs PN 400		
		NPT
1/2" inv.	IV3R4N-SS	65-277
Ventilblock 3-vägs PN 400		
		NPT
1/2" inv. x direktfläns	IVM3D4N-SS	65-265
Ventilblock 3-vägs PN 400		
		NPT
1/2" inv. x direktfläns	3VDTH15NS-V	65-273
Ventilblock PN 400 direktfläns med stumsvets (Butt Weld)		
2-vägs, Rör 21,3 mm, L=100 mm		65-253
5-vägs, Rör 21,3 mm, L=100 mm		65-295
Ventilblock 5-vägs PN 400		
		NPT
1/2" inv.	IV5R4N-SS	65-293
Ventilblock 5-vägs PN 400		
		NPT
1/2" inv. x direktfläns	IVM5D4N-SS	65-285
1/2" inv. x direktfläns	IVM5D4N-A-SS	65-281



I.A.C. Komponenter AB
International Automation Components

P.O. Box 60, S-566 22 Habo • Phone: +46 (0)36 477 00 • Fax: +46 (0)36 477 15
E-mail: habo@iackomp.se • www.iackomp.se • Reg.No. 556461-2983

Flödesregulator & Manometer

Flödesregulator

- Fabrikat: Meiflow • Flödesregulatorn håller konstant flöde oavsett tryckförändring.

Manometer

- Vi erbjuder allt från enkla manometrar i plast och lackad plåt till processmanometrar i rostfritt och för höga tryck.

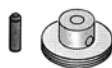
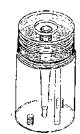

Dimension		Artikelnummer		
Flödesregulator Meiflow				
Water 400	0.04 – 0.4 lit/min	syrafast	PN 40	71-011
Water 1	0.1 – 1.0 lit/min	syrafast	PN 40	71-012
Air 5	1.0 – 5.0 lit/min	syrafast	PN 40	71-014
Water 400	0.04 – 0.4 lit/min	delrin		71-051
Water 1	0.1 – 1.0 lit/min	delrin		71-052
Indikator komplett				
W 200	Part 7-8,10-15			71-055
W 400	Part 7-8,10-15			71-056
W1	Part 7-8,10-15			71-057
A5	Part 7-8,10-15			71-058
Indikator				
W 400	Part 12			71-063
W 1	Part 12			71-064
Membran				
W200, W400, W1, A5	Part 6			71-070
Mätplugg				
W200, W400, A5	Part 7			71-071
W1	Part 7			71-072
Kula				
W200, W400, W1,	Part 8			71-075
O-ring				
	Part 10			71-080
	Part 11			71-081
Flottör				
W1,	Part 5			71-069
Manometer ansl. ned				
0- 6 bar	40 mm 1/8"R	plast		22-102
0-12 bar	40 mm 1/8"R	plast		22-104
Manometer ansl. bak				
0- 4 bar	40 mm 1/8"R	plast		22-105
0- 6 bar	40 mm 1/8"R	plast		22-106
0-10 bar	40 mm 1/8"R	plast		22-107
0-12 bar	40 mm 1/8"R	plast		22-108
Manometer ansl. bak				
0-4 bar	40 mm 1/8"	metall		22-005
0-4 bar	63 mm 1/8"	metall		22-006
0-16 bar	40 mm 1/8"	metall		22-003



I.A.C. Komponenter AB
International Automation Components

P.O. Box 60, S-566 22 Habo • Phone: +46 (0)36 477 00 • Fax: +46 (0)36 477 15
E-mail: habo@iackomp.se • www.iackomp.se • Reg.No. 556461-2983

Flödesregulator & Manometer

Flödesregulator

- Fabrikat: Meiflow • Flödesregulatorn håller konstant flöde oavsett tryckförändring.

Manometer

- Vi erbjuder allt från enkla manometrar i plast och lackad plåt till processmanometrar i rostfritt och för höga tryck.



Dimension

Artikelnummer

Manometer max 400 bar glycerinfyllt rostfritt hus

Ø 63 mm, 1/4" ansl. mässing, anslutn. ned, *	22-410
Ø 63 mm, 1/4" ansl. mässing, anslutn. bak, *	22-415

Manometer max 400 bar glycerinfyllt rostfritt hus

Ø 63 mm, 1/4" ansl. rostfri, anslutn. ned, *	22-420
Ø 63 mm, 1/4" ansl. rostfri, anslutn. bak, *	22-425

Manometer max 1000 bar glycerinfyllt rostfritt hus

Ø 63 mm, 1/4" ansl. rostfri, anslutn. ned, *	22-430
Ø 63 mm, 1/4" ansl. rostfri, anslutn. bak, *	22-435

Manometer max 400 bar glycerinfyllt rostfritt hus

Ø 100 mm, 1/2" ansl. rostfri, anslutn. ned, *	22-440
Ø 100 mm, 1/2" ansl. rostfri, anslutn. bak, *	22-445

Manometer max 1000 bar glycerinfyllt rostfritt hus

Ø 100 mm, 1/2" ansl. rostfri, anslutn. ned, *	22-450
Ø 100 mm, 1/2" ansl. rostfri, anslutn. bak, *	22-455

* Ange tryckområde vid beställning

Digitaldisplay

För Trycktransmitter 4-20mA	22-471
-----------------------------	--------

Digital manometer

LEO-2 1/4" 0-300bar	62-200
---------------------	--------



I.A.C. Komponenter AB
International Automation Components

P.O. Box 60, S-566 22 Habo • Phone: +46 (0)36 477 00 • Fax: +46 (0)36 477 15
E-mail: habo@iackomp.se • www.iackomp.se • Reg.No. 556461-2983

Flödesregulator & Manometer

Tillbehör manometer

- Vi ger här några förslag på olika monteringsalternativ för anslutning av manometer.

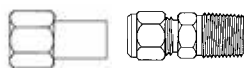

Dimension

Artikelnummer

Kopplingsadapter + koppling utv. gänga

BSPP

1/4" inv. x Rör 6 YD	42-462
6 mm x 1/4" utv.	42-301
1/2" inv. x Rör 12 YD	42-479
12 mm x 1/2" utv.	42-312

Övriga kombinationer - se del 1, rörkopplingar



Rak koppling inv. gänga

BSPP

6 mm x 1/4" inv.	42-317
12 mm x 3/8" inv.	42-324
12 mm x 1/2" inv.	42-325

Övriga dimensioner - se del 1, rörkopplingar



Manometeradapter vridbar

1/2" inv. BSPP x 1/2" utv. NPT	61-6492
--------------------------------	---------

Övriga dimensioner - se del 12, nålventiler



Manometeradapter vridbar, 2-delad

1/2" inv. BSPP x 1/2" utv. NPT	61-198
--------------------------------	--------



Manometermutter

3/8" inv. BSPP höger/vänster gänga	61-188
1/2" inv. BSPP höger/vänster gänga	61-189



Manometernippel

1/2" utv. BSPP x 1/2" utv. NPT	61-192
--------------------------------	--------

Övriga dimensioner - se del 12, nålventiler



Manometerventil

NPT

1/2" inv. x utv.	61-648
------------------	--------



1/4" koppar	87-110
1/2" koppar	87-112



1/4" 2343	87-010
1/2" 2343	87-012

Övriga dimensioner - se del 16, packningar



I.A.C. Komponenter AB
International Automation Components

P.O. Box 60, S-566 22 Habo • Phone: +46 (0)36 477 00 • Fax: +46 (0)36 477 15
E-mail: habo@iackomp.se • www.iackomp.se • Reg.No. 556461-2983

Bult och skruv

- Vi lagerför efter ert behov. Har ni något önskemål, vänligen fråga oss.
- Syrafast 316 - 2343 (A4)



Dimension	Artikelnummer
Sexkantsbult	Syrafast
M5 x 10 mm	84-2005
M5 x 20 mm	84-203
M5 x 25 mm	84-204
M5 x 30 mm	84-205
M5 x 50 mm	84-207
M6 x 8 mm	84-210
M6 x 10 mm	84-2105
M6 x 12 mm	84-211
M6 x 16 mm	84-212
M6 x 20 mm	84-213
M6 x 25 mm	84-214
M6 x 30 mm	84-215
M6 x 35 mm	84-2155
M6 x 40 mm	84-216
M6 x 45 mm	84-2165
M6 x 50 mm	84-217
M6 x 70 mm	84-2183
M6 x 80 mm	84-2185
M8 x 12 mm	84-221
M8 x 16 mm	84-222
M8 x 20 mm	84-223
M8 x 25 mm	84-224
M8 x 30 mm	84-225
M8 x 40 mm	84-226
M8 x 45 mm	84-2265
M8 x 50 mm	84-227
M8 x 60 mm	84-228
M8 x 70 mm	84-2283
M10 x 20 mm	84-233
M10 x 35 mm	84-2365
M10 x 40 mm	84-237
M10 x 50 mm	84-2373



Mutter	Syrafast
Mutter M4	84-264
Mutter M5	84-265
Mutter M6	84-266
Mutter M8	84-268
Mutter M10	84-270



Spårskruv	Syrafast
M3 x 16 mm	84-402
M4 x 16 mm	84-407
M4 x 20 mm	84-408
M4 x 25 mm	84-409
M5 x 12 mm	84-411
M5 x 20 mm	84-413
M6 x 20 mm	84-423
M6 x 25 mm	84-424
M6 x 30 mm	84-425
M6 x 35 mm	84-4255
M6 x 40 mm	84-426
M6 x 45 mm	84-4265
M6 x 50 mm	84-427











I.A.C. Komponenter AB
International Automation Components

P.O. Box 60, S-566 22 Habo • Phone: +46 (0)36 477 00 • Fax: +46 (0)36 477 15
E-mail: habo@iackomp.se • www.iackomp.se • Reg.No. 556461-2983

Bult & Skruv

Bult och skruv

- Vi lagerför efter ert behov. Har ni något önskemål, vänligen fråga oss.
- Syrafast 316 - 2343 (A4), där inget annat anges.

Dimension	Artikelnummer	
 Insexskruv	Syrafast	
M6 x 20 mm	84-453	
M6 x 25 mm	84-454	
M6 x 30 mm	84-455	
M6 x 35 mm	84-4555	
M6 x 40 mm	84-456	
M6 x 45 mm	84-457	
M10 x 12 mm	57-095	
 Fransk träskruv	Galvad	
8 x 65 mm FZV	84-506	
 Expanderbult	Galvad	
M6 x 40 mm FZB	84-110	
M8 x 50 mm FZB	84-111	
 Expanderbult	Syrafast	
M8 x 50 mm	84-131	
 Båtbricka	Syrafast	
4,3 x 12 x 1,0	84-492	
5,3 x 15 x 1,2	84-493	
6,4 x 18 x 1,6	84-494	
8,4 x 24 x 2,0	84-495	
10,5 x 30 x 2,5	84-496	
 Planbricka	Syrafast	
4,3 x 9 x 0,8	84-482	
5,3 x 10 x 1,0	84-483	
6,4 x 12 x 1,6	84-484	
8,4 x 16 x 1,6	84-485	
10,5 x 21 x 2,0	84-486	
 Flänsmutter	Rostfri	
M8	100 st/förp	84-288
M10	"	84-290
 Sexkantsbult med spets	Syrafast	
M8 x 25 mm	84-352	
M8 x 30 mm	84-350	
M8 x 40 mm	84-354	
 Krysskruv MRX	Syrafast	
M5 x 16 mm	84-312	
M5 x 20 mm	84-313	
M5 x 25 mm	84-314	
M5 x 30 mm	84-315	













I.A.C. Komponenter AB
International Automation Components

P.O. Box 60, S-566 22 Habo • Phone: +46 (0)36 477 00 • Fax: +46 (0)36 477 15
E-mail: habo@iackomp.se • www.iackomp.se • Reg.No. 556461-2983

Packning & Tätning

Packning och tätning

- Vi lagerför efter ert behov. Har ni något önskemål, vänligen fråga oss.

Dimension	Artikelnummer	
Packningar rörgångor		
	1/8" koppar	87-099
	1/4" koppar	87-100
	3/8" koppar	87-101
	1/2" koppar	87-102
	3/4" koppar	87-103
	1" koppar	87-104
	1/4" 2343	87-001
	3/8" 2343	87-002
	1/2" 2343	87-003
		1/4" koppar, för manometer
3/8" koppar, för manometer		87-111
1/2" koppar, för manometer		87-112
	1/4" 2343, för manometer	87-010
	3/8" 2343, för manometer	87-011
	1/2" 2343, för manometer	87-012
	1/4" tredo, gummi-stål	87-301
	3/8" tredo, gummi-stål*	87-302
	1/2" tredo, gummi-stål	87-303
	3/4" tredo, gummi-stål	87-304
	1/4" "NBR" plast	87-401
	3/8" "NBR" plast	87-402
	1/2" "NBR" plast	87-403
	3/4" "NBR" plast	87-404
	1" "NBR" plast	87-405
Packbox ventilblock		
	TEFLON klinger	87-356
	PTFE Ives	87-375
	GRAPHOIL Ives	87-376
	PTFE Alco	87-385
Packningar ventilblock		
	Klinger-A 24x18x3 PTFE	87-350
	Klinger-B 18,72x2,62 O-ring	87-351
	Ives 24x18x2,7 PTFE	87-370
	Ives 25x19x3 PTFE	87-3701
	Alco 22x19x2 PTFE	87-380
	Safelok 25x18x3,5 PTFE	87-390
Gängtejp		
	12m x 12mm x 0,075mm PTFE	86-001
	5m x 12mm x 0,2mm PTFE	86-003
	12m x 12mm x 0,1mm PTFE	86-005
Gängtätning		
 	Loctite 577 - 50 ml	86-120
	Loctite 5400 - 50 ml (Safety & Health)	86-121
	Smörjolja	86-105
Rostskyddskapsel Zerust kapsel som avger rostskyddsånga		
	30 cm VC1-1år	88-010
	60 cm VC2-1år	88-020
	60 cm VC2-2 år	88-030
	180 cm VC6-2 år	88-040



I.A.C. Komponenter AB

International Automation Components

P.O. Box 60, S-566 22 Habo • Phone: +46 (0)36 477 00 • Fax: +46 (0)36 477 15

E-mail: habo@iackomp.se • www.iackomp.se • Reg.No. 556461-2983

Elkabel & Kabelförskruvning

Elkabel

• FKAR– PG och TG går även att erhållas med hölje blå.

Dimension	E-nr.	Artikelnummer
Korskopplingstråd		
2 x 22 AWG orange/grön-orange		07-100
2 x 22 AWG gul/blå-gul		07-101
2 x 22 AWG blå/gul		07-105
Korskopplingstråd		
2 x 0.5 mm ² blå/röd		07-110
2 x 0.5 mm ² röd/vit		07-111
2 x 0.5 mm ² brun/vit		07-112
2 x 0.5 mm ² blå/vit		07-113
2 x 0.5 mm ² orange/vit		07-114
2 x 0.5 mm ² blå/gul		07-115
2 x 0.5 mm ² blå/vit-blå/röd		07-116
2 x 0.5 mm ² vit/vit nr.märkt 1-2		07-120
2 x 0.5 mm ² svart/svart nr.märkt 1-2		07-121
2 x 0.5 mm solid orange/vit		07-150
2 x 0.5 mm solid grön/vit		07-170
1 x 0.5 mm ² röd		07-200
1 x 0.5 mm ² vit		07-201
Signalkabel FQAR – PG halogenfri		
2 x 0.5 mm ²		07-531
2 x 2 x 0.5 mm ²		07-532
2 x 1.0 mm ²		07-538
2 x 2 x 1.0 mm ²		07-539
Styrkabel		
KJAAM 2 x (2+1) x 0.5 mm ²		07-305
ÖLFLEX 4 x 1.0 mm ²		07-315

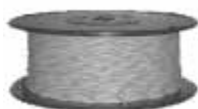

I.A.C. Komponenter AB
International Automation Components

P.O. Box 60, S-566 22 Habo • Phone: +46 (0)36 477 00 • Fax: +46 (0)36 477 15
E-mail: habo@iackomp.se • www.iackomp.se • Reg.No. 556461-2983

Elkabel & Kabelförskruvning

Elkabel och kabelförskruvning

- Vi lagerför kabelförskruvningar i olika utförande och modeller.
- EMC-kabelförskruvning säkerställer förbindelsen mellan skärmen på kabeln och plåthöljet i skåpet.
- EMC - Electromagnetic Compatibility

Dimension

Artikelnummer

Kabelförskruvning



18.6 x 1/2"	förnicklad	05-010
18.6/PG11	polyamid	05-051
20.4/PG13	polyamid	05-052
54/PG42	polyamid	05-057
15.2/PG9	polyamid förlängd gänga	05-060
18.6/PG11	polyamid förlängd gänga	05-061
20.4/PG13	polyamid förlängd gänga	05-062
22.5/PG16	polyamid förlängd gänga	05-063
28.3/PG21	polyamid förlängd gänga	05-064
37/PG29	polyamid förlängd gänga	05-065

Kontramutter



15.2/PG9	förnicklad	05-075
18.6/PG11	förnicklad	05-076
20.4/PG13	förnicklad	05-077
22.5/PG16	förnicklad	05-078
28.3/PG21	förnicklad	05-079
37/PG29	förnicklad	05-080
54/PG42	förnicklad	05-082
15.2/PG9	polyamid	05-085
18.6/PG11	polyamid	05-086
20.4/PG13	polyamid	05-087
22.5/PG16	polyamid	05-088
28.3/PG21	polyamid	05-089
37/PG29	polyamid	05-090
54/PG42	polyamid	05-092

EMC-kabelförskruvning



22.5/PG16	förnicklad	05-305
28.3/PG21	förnicklad	05-306
37/PG29	förnicklad	05-307
47/PG36	förnicklad	05-308

EMC-kontramutter



22.5/PG16	förnicklad	05-325
28.3/PG21	förnicklad	05-326
37/PG29	förnicklad	05-327
47/PG36	förnicklad	05-328













I.A.C. Komponenter AB
International Automation Components

P.O. Box 60, S-566 22 Habo • Phone: +46 (0)36 477 00 • Fax: +46 (0)36 477 15
E-mail: habo@iackomp.se • www.iackomp.se • Reg.No. 556461-2983

Verktyg & tillbehör

Verktyg och tillbehör

- Vi lagerför efter ert behov. Har ni något önskemål, vänligen fråga oss.

	Produkt	Artikelnummer
	Mantelskalare	
	4,2 - 25 mm	91-012
	Kabelkniv	
	Kabelkniv	91-013
	För skalning av Osnaline kabel	
	Röravskärare för plaströr	
	Plast 1-15 mm	91-031
	Reservblad	91-035
	Svetsselektrod	
	1,6 x 300 mm OK 63.30	91-101
	2,0 x 300 mm OK 63.30	91-102
	Kapskiva för stål	
	125 x 1,0 x 22 Mega-Line 25 st/förp	93-0020
	125 x 1,6 x 22 Mega-Line "	93-0022
	125 x 2,0 x 22 Mega-Line "	93-0025
	180 x 2,0 x 22 Mega-Line "	93-0042
	Slipskiva lamell för stål	
	125 x 22 XT Rak Z80 10 st/förp	93-1139
	125 x 22 Ciafiber Rak Z80 "	93-1173
	Rengöringsrondell till borrar maskin	
	150 x 13 x 8 svart	93-1434
	150 x 13 x 8 blå	93-1451
	150 x 13 x 8 lila	93-1452
	150 x 13 x 8 orange	93-1455
	Rengöringsrondell till vinkelslip	
	115 x 22 rak orange 5 st/förp	93-1417
	Bågfilmsblad	
	300 x 18 tänder/tum	91-403
	300 x 24 tänder/tum	91-404
	300 x 32 tänder/tum	91-405
	Handskar	
	Getnarv Tegera stl 8	91-913
	Getnarv Tegera stl 10	91-915
	Svinnarv halvfodrad stl dam	91-901
	Svinnarv halvfodrad stl herr	91-902



I.A.C. Komponenter AB

International Automation Components

P.O. Box 60, S-566 22 Habo • Phone: +46 (0)36 477 00 • Fax: +46 (0)36 477 15
E-mail: habo@iackomp.se • www.iackomp.se • Reg.No. 556461-2983

Verktyg & tillbehör

Verktyg och tillbehör

- Bockverktyg för koppar, aluminium och rostfria rör. Graderade från 0-180°
- Vi lagerför efter ert behov. Har ni något önskemål, vänligen fråga oss.



Produkt

Artikelnummer

Röravskärare för stålrör

6 - 35 mm EGO 735	91-017
Trissa stålrör för 735-750	91-019
Trissa stålrör för 753	91-020

Röravskärare för stålrör

6 - 35 mm Ridgid 150	91-021
6 - 60 mm Ridgid 205	91-023
Trissa stålrör Ridgid E-4546	91-025

Röravskärare för stålrör

6 - 35 mm 6635-1	91-027
Trissa stålrör för 6635-1	91-029

Gradningsverktyg för stålrör

6 - 35 mm	91-041
-----------	--------

Gradningsverktyg

Gradningsverktyg	91-042
------------------	--------

Stegborr

4 - 30 mm	91-043
-----------	--------

Bockverktyg för rör

6 mm - Ridgid 406M	91-051
8 mm - Ridgid 408M	91-052
10 mm - Ridgid 310M	91-055
12 mm - Ridgid 312M	91-056

Bockverktyg för rör

10 mm - Ridgid 610M	91-045
12 mm - Ridgid 612M	91-046

Bockverktyg för rör, med utväxling

15mm Fromax Nr. 55	91-057
5/8" - Ridgid 358 (16mm)	91-058
3/4" - Ridgid 368 (18-19mm)	91-059

Bockverktyg för rör

6 mm - MS-HTB-6M	91-061
8 mm - MS-HTB-8M	91-062
10 mm - MS-HTB-10M	91-063
12 mm - MS-HTB-12M	91-064











I.A.C. Komponenter AB
International Automation Components

P.O. Box 60, S-566 22 Habo • Phone: +46 (0)36 477 00 • Fax: +46 (0)36 477 15
E-mail: habo@iackomp.se • www.iackomp.se • Reg.No. 556461-2983

Verktyg & tillbehör

Verktyg och tillbehör

- Vi lagerför efter ert behov. Har ni något önskemål, vänligen fråga oss.

	Produkt	Artikelnummer
	Elbockverktyg för rör	
	18-22-28 mm Robend 4000	91-0705
	15-18-22-28 mm Robend 4000 E (batteri)	91-0709
	Schablonsats rör Robend 3000/4000	
	12 mm (inkl. glidsko)	91-071
	14 mm "	91-072
	15 mm "	91-073
	16 mm "	91-074
	18 mm "	91-075
	20 mm "	91-076
	22 mm "	91-077
	1" - 25 mm "	91-078
	28 mm "	91-079
	1 1/4" - 32 mm "	91-0795
	Glidsko rör Robend 3000/4000	
	12 mm	91-081
	14 mm	91-082
	15 mm	91-083
	16 mm	91-084
	18 mm	91-085
	20 mm	91-086
	22 mm	91-087
	1" - 25 mm	91-088
28 mm	91-089	
	1 1/4" - 32 mm	91-0895
	Stativ för Robend	
	Stativ	91-068
	Stativ förlängare 500mm	91-069
	Konstång	
	L = 400 mm	91-090
	Kondon	
	16 mm ID	91-092
	18 mm ID	91-093
	22 mm ID	91-094
	25 mm ID	91-096
	Ringnyckel öppningsbar	
	19 mm (för 10mm klämringsskoppling)	91-245
	22 mm (för 12mm klämringsskoppling)	91-248
	Ringnyckel öppen	
	19 x 22 mm	91-255



I.A.C. Komponenter AB

International Automation Components

P.O. Box 60, S-566 22 Habo • Phone: +46 (0)36 477 00 • Fax: +46 (0)36 477 15

E-mail: habo@iackomp.se • www.iackomp.se • Reg.No. 556461-2983

Verktyg & tillbehör

Verktyg och tillbehör

- Bockverktyg för koppar, aluminium och rostfria rör. Graderade från 0-180°
- Vi lagerför efter ert behov. Har ni något önskemål, vänligen fråga oss.



Produkt	Artikelnummer
Urkopplingsverktyg för slangkopplingar	
4 - 14 mm	91-005
3 - 10 mm	91-006



I.A.C. Komponenter AB
International Automation Components

P.O. Box 60, S-566 22 Habo • Phone: +46 (0)36 477 00 • Fax: +46 (0)36 477 15
E-mail: habo@iackomp.se • www.iackomp.se • Reg.No. 556461-2983